

1:	7.3	→
2:	8.0	↘
3:	7.1	→
4:	5.8	↙
5:	7.1	↘
6:	9.4	↗
7:	5.5	→
8:	7.6	↗
9:	7.1	↗
10:	8.4	↙
Series		70.0
Total		70.0

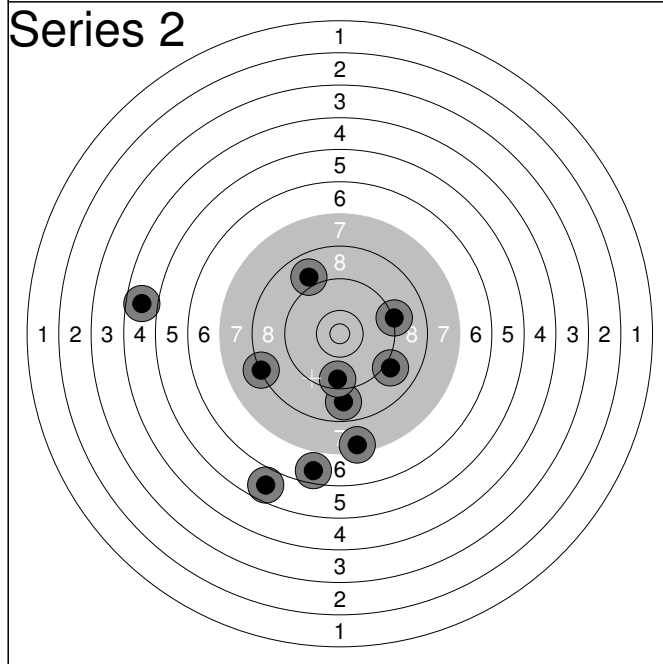

11:	8.3	↙
12:	9.2	→
13:	6.6	↘
14:	9.1	↘
15:	5.7	↙
16:	8.9	↗
17:	8.8	↘
18:	7.5	↘
19:	9.6	↘
20:	4.7	↙
Series		73.0
Total		143.0

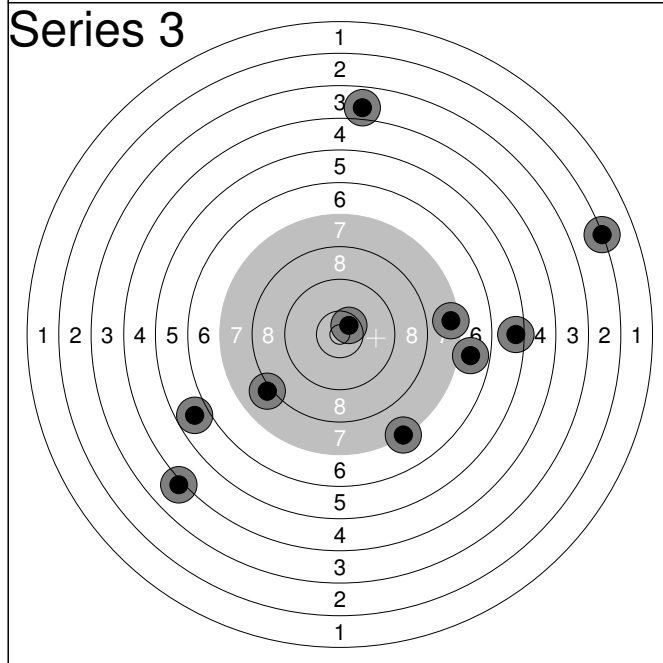

21:	5.5	→
22:	3.9	↑
23:	5.8	↙
24:	7.5	→
25:	4.1	↙
26:	2.2	→
27:	8.1	↙
28:	10.6x	↗
29:	6.8	→
30:	7.3	↘
Series		57.0
Total		200.0

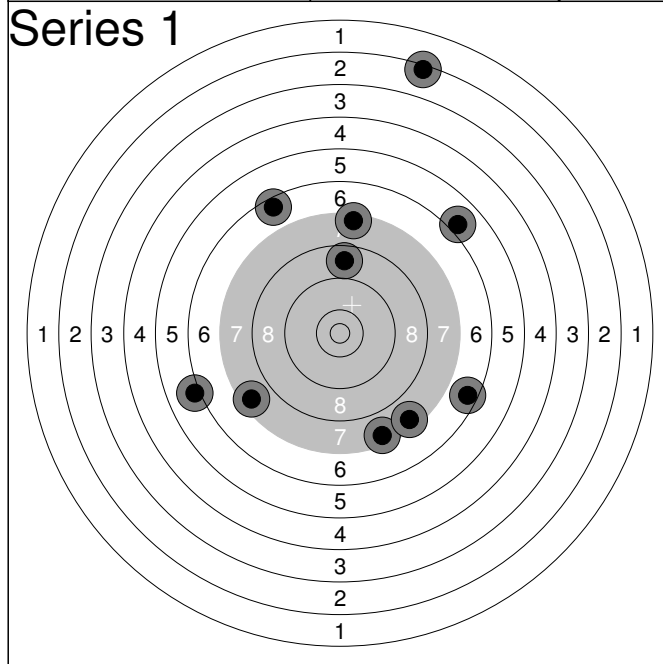

1:	7.4	↑
2:	7.5	↓
3:	8.7	↑
4:	7.5	↓
5:	6.1	←
6:	6.5	↖
7:	2.4	↑
8:	6.0	↗
9:	7.5	↙
10:	6.5	→
Series		62.0
Total		62.0

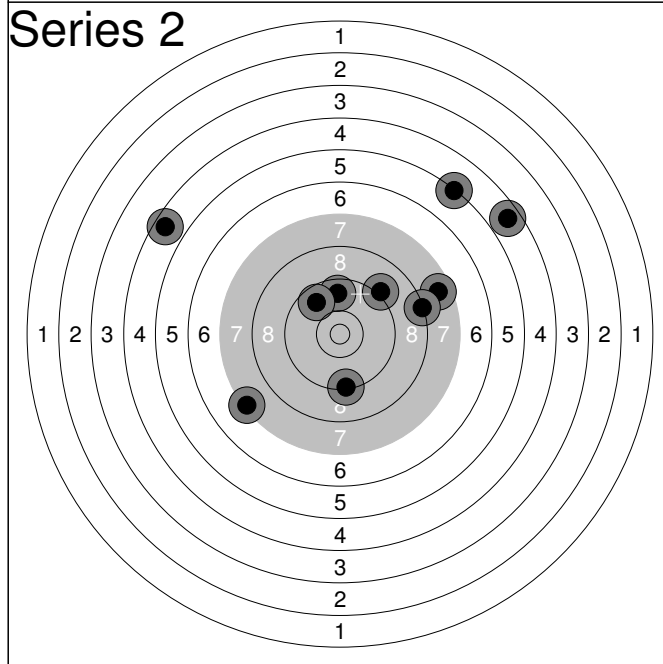

11:	4.6	↗
12:	7.6	→
13:	9.7	↑
14:	8.3	→
15:	9.7	↖
16:	4.6	↙
17:	9.3	↓
18:	9.1	↗
19:	7.3	↙
20:	5.2	↗
Series		71.0
Total		133.0

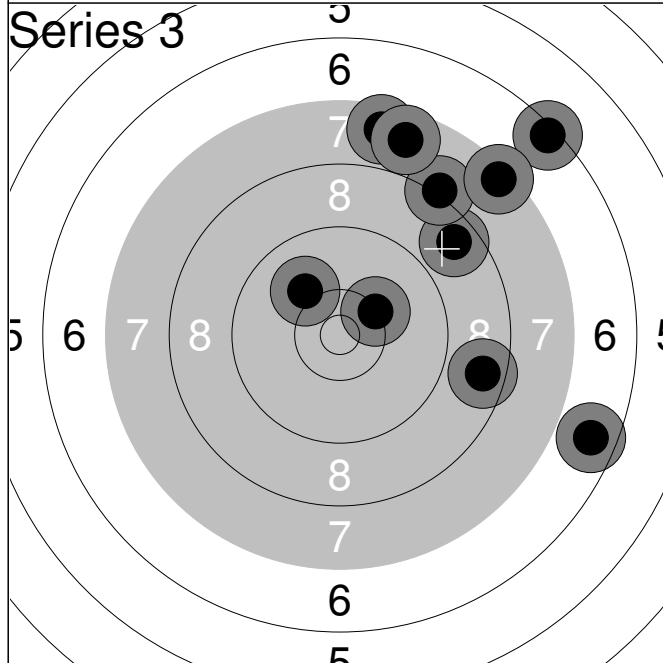

21:	8.6	↗
22:	8.2	↗
23:	7.6	↑
24:	8.6	→
25:	6.6	→
26:	6.4	↗
27:	7.7	↑
28:	10.3	↗
29:	7.4	↗
30:	10.1	↖
Series		77.0
Total		210.0

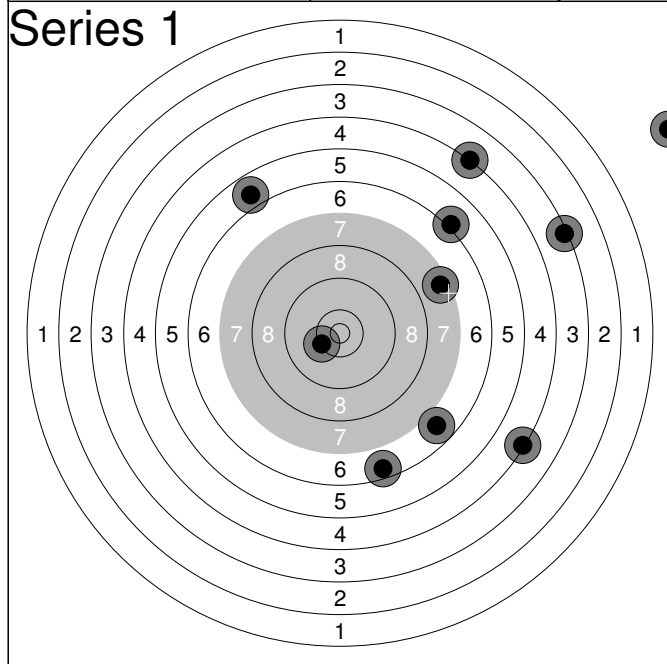

1:	6.1	↗
2:	3.3	→
3:	4.3	↘
4:	0.0	↗
5:	7.5	↗
6:	10.3	↖
7:	4.2	↗
8:	6.5	↘
9:	6.8	↘
10:	5.8	↗
Series	51.0	
Total	51.0	

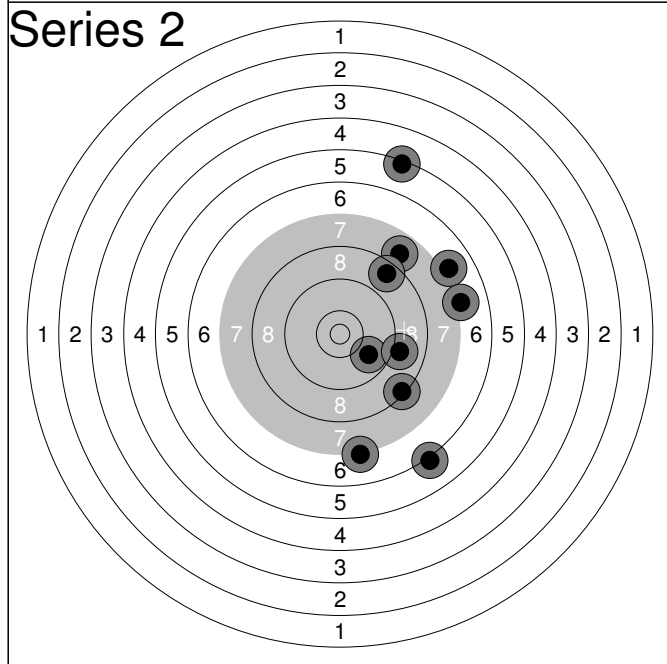

11:	7.2	↘
12:	6.1	↘
13:	9.9	↘
14:	7.9	↗
15:	8.6	↗
16:	7.0	↗
17:	5.3	↗
18:	9.0	→
19:	7.1	→
20:	8.3	↘
Series	73.0	
Total	124.0	

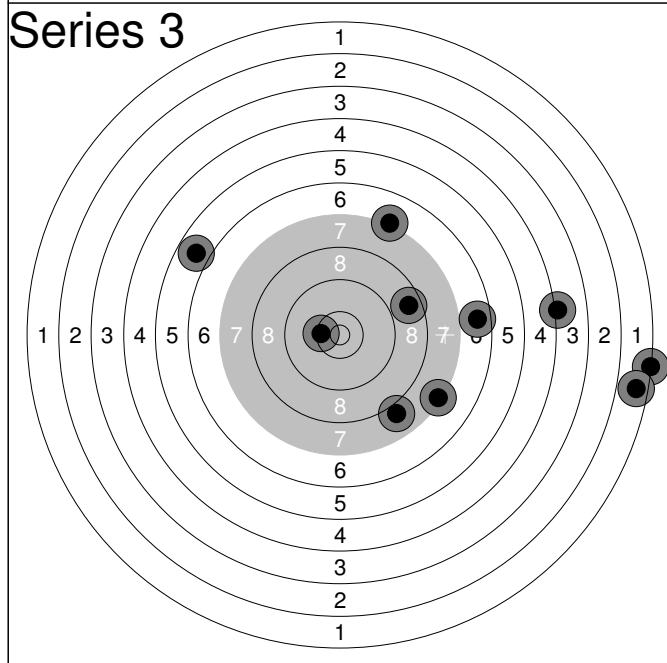

21:	1.3	→
22:	1.6	→
23:	8.6	↗
24:	4.1	→
25:	7.2	↗
26:	7.9	↘
27:	5.8	↗
28:	10.4	←
29:	7.3	↘
30:	6.7	→
Series	56.0	
Total	180.0	

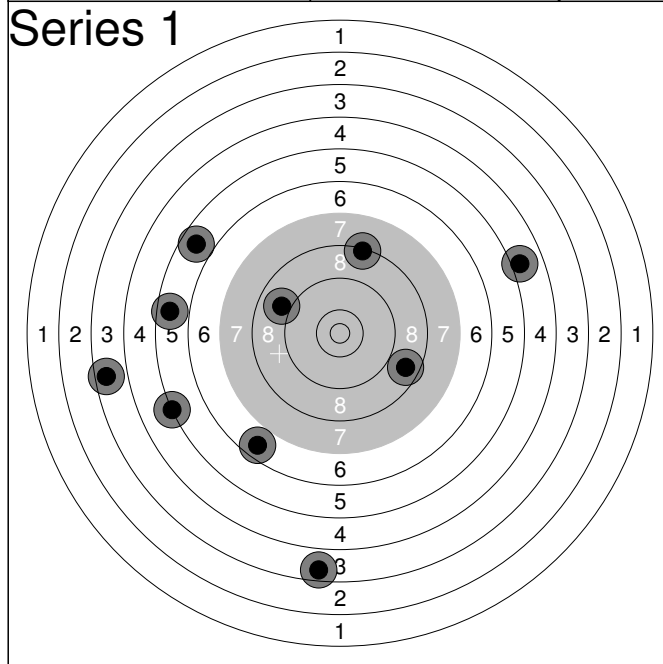

1:	5.2	←
2:	6.6	↙
3:	5.6	←
4:	8.9	↗
5:	8.3	↑
6:	3.6	←
7:	5.7	↗
8:	3.6	↓
9:	8.7	↘
10:	5.0	→
Series		56.0
Total		56.0

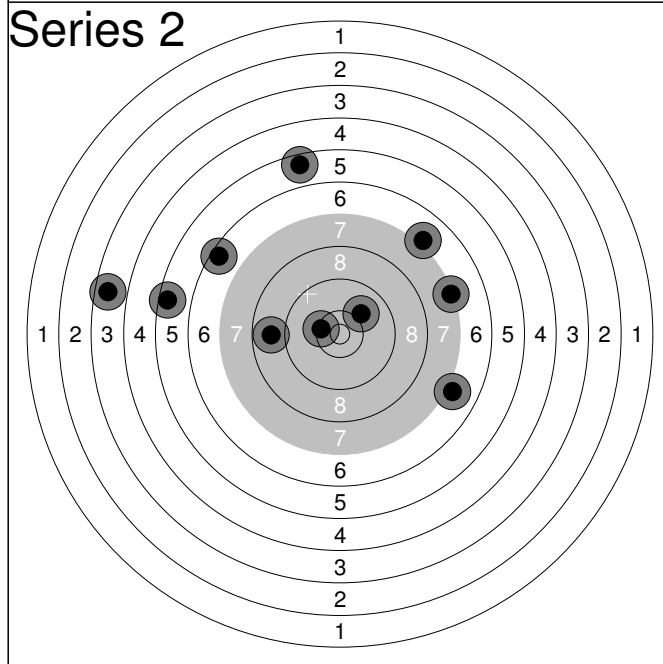

11:	10.0	↗
12:	7.3	→
13:	7.0	↘
14:	10.4	←
15:	8.8	←
16:	6.5	↗
17:	5.5	←
18:	7.1	↗
19:	3.6	←
20:	5.5	↑
Series		68.0
Total		124.0

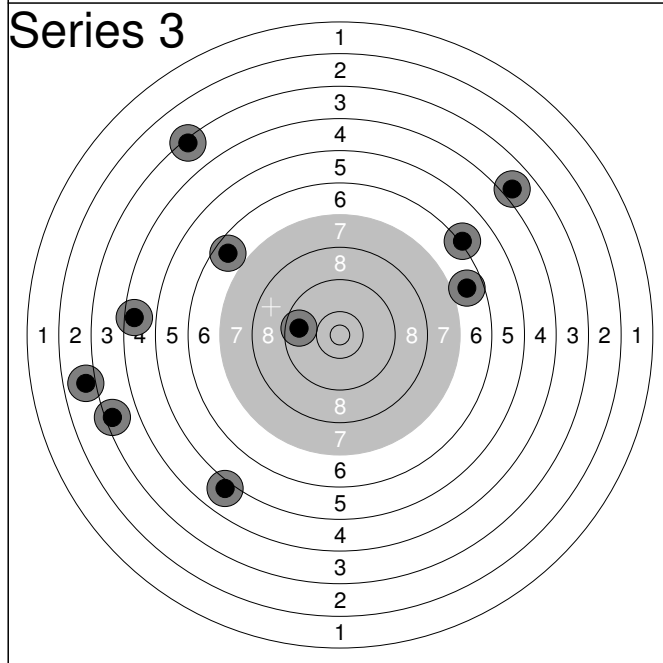

21:	9.7	←
22:	3.4	←
23:	6.7	→
24:	4.6	←
25:	3.4	↗
26:	3.9	↗
27:	6.7	↗
28:	5.0	↙
29:	2.9	←
30:	6.2	↗
Series		47.0
Total		171.0

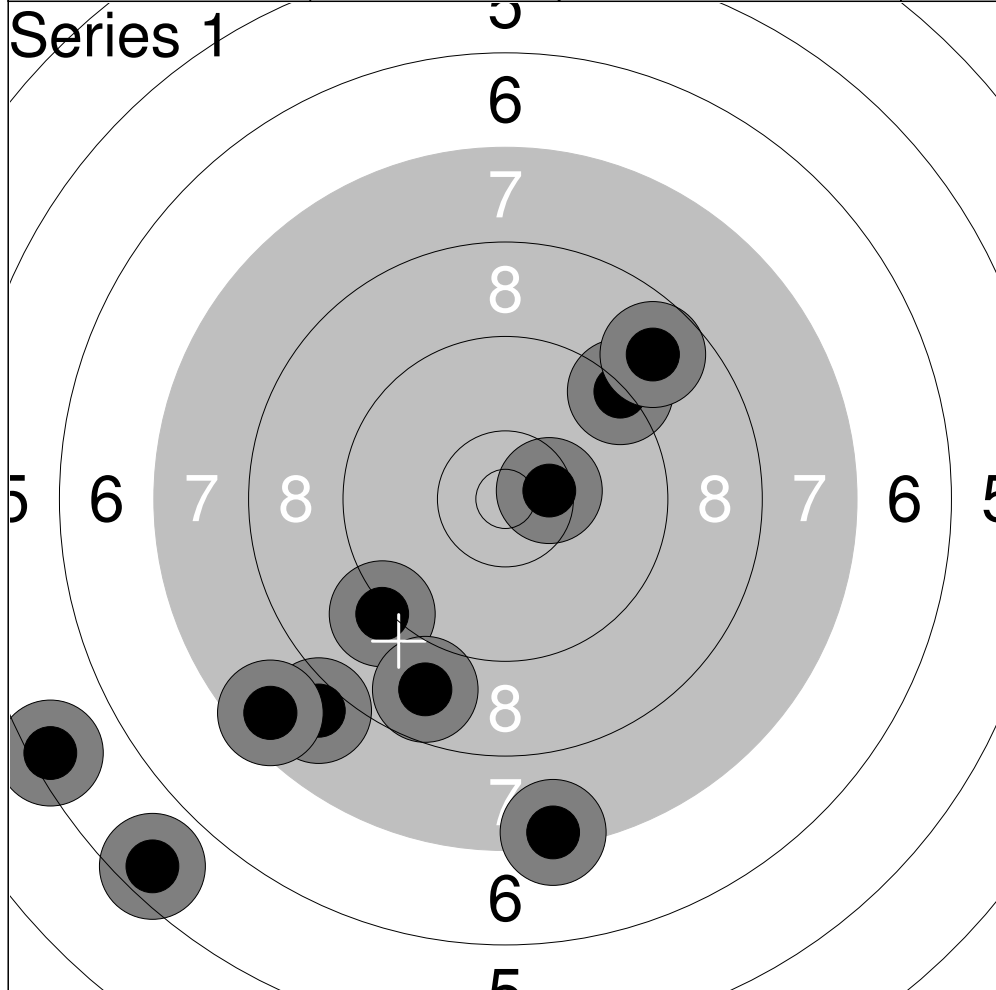

1:	9.2	↙
2:	8.8	↘
3:	9.3	↗
4:	10.5x	→
5:	7.4	↘
6:	8.8	↗
7:	5.4	↙
8:	8.0	↘
9:	5.6	↘
10:	7.6	↘

Series	76.0
Total	76.0

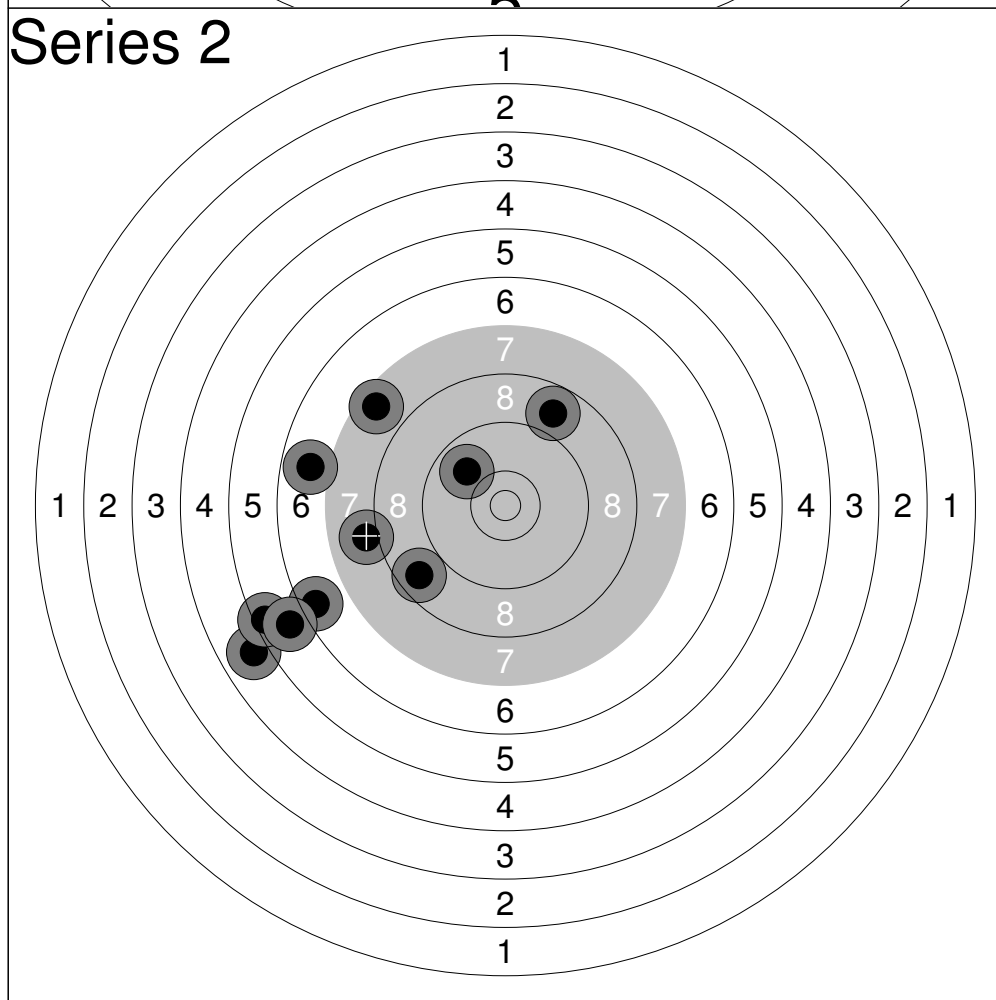

11:	4.9	↙
12:	6.5	↙
13:	9.9	↖
14:	5.4	↙
15:	5.9	↙
16:	7.6	↖
17:	8.8	↗
18:	8.0	↙
19:	8.7	↘
20:	6.8	↙

Series	66.0
Total	142.0

Series 1

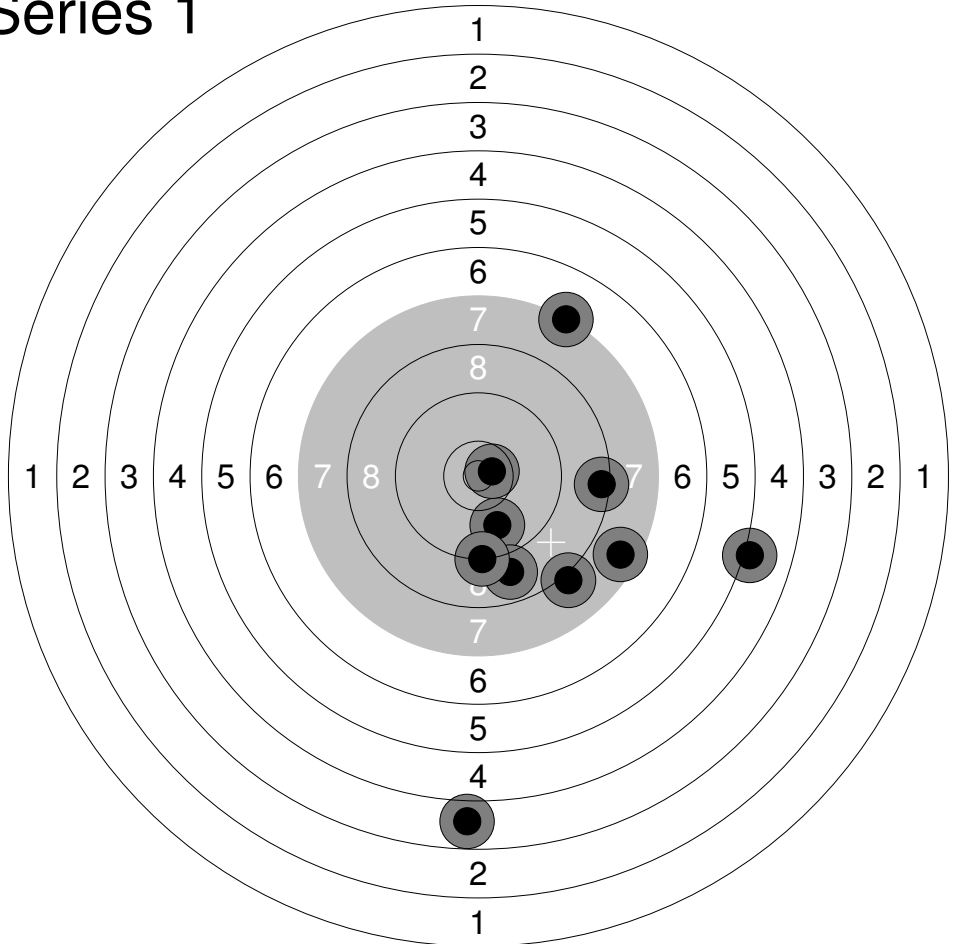

1:	5.1	→
2:	3.8	↓
3:	7.2	↗
4:	9.9	↓
5:	8.9	↓
6:	7.6	↘
7:	9.2	↓
8:	8.4	→
9:	10.7x	→
10:	8.1	↘

Series	74.0
Total	74.0

Series 2

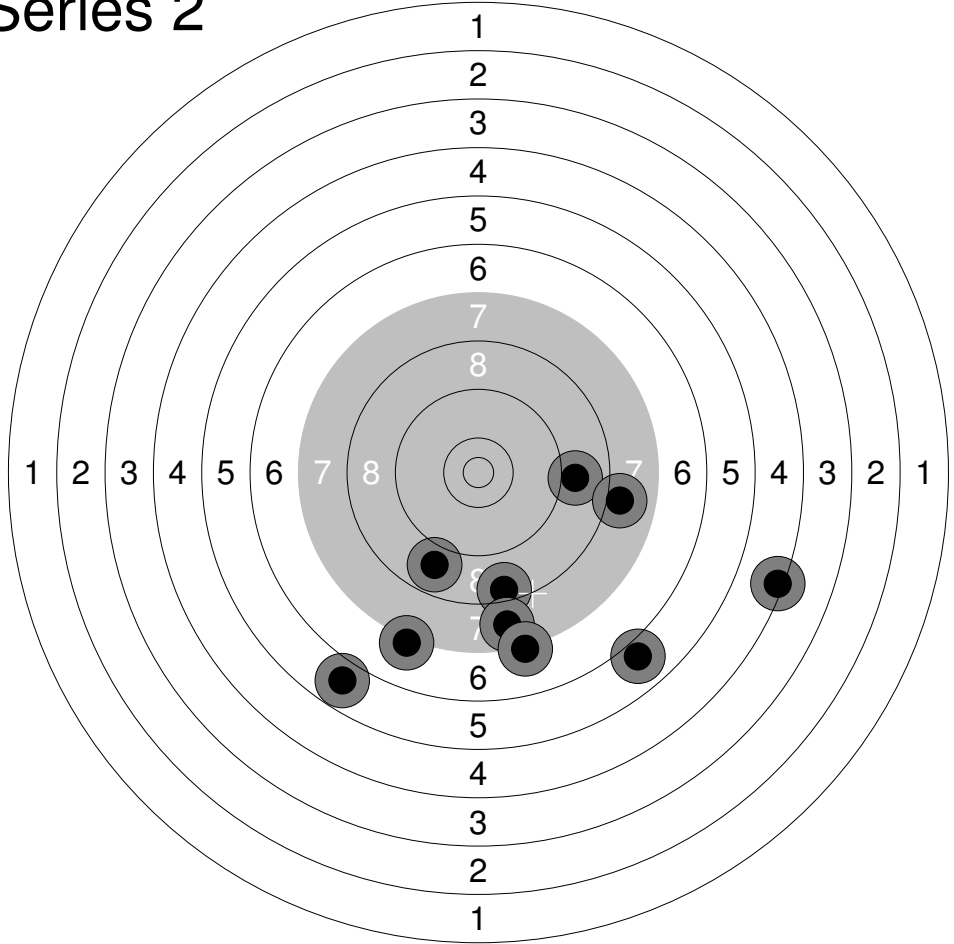

11:	8.5	↓
12:	8.9	→
13:	4.4	→
14:	7.1	↘
15:	5.9	↘
16:	5.8	↘
17:	7.8	↓
18:	8.8	↘
19:	8.0	→
20:	7.2	↘

Series	67.0
Total	141.0

Series 1

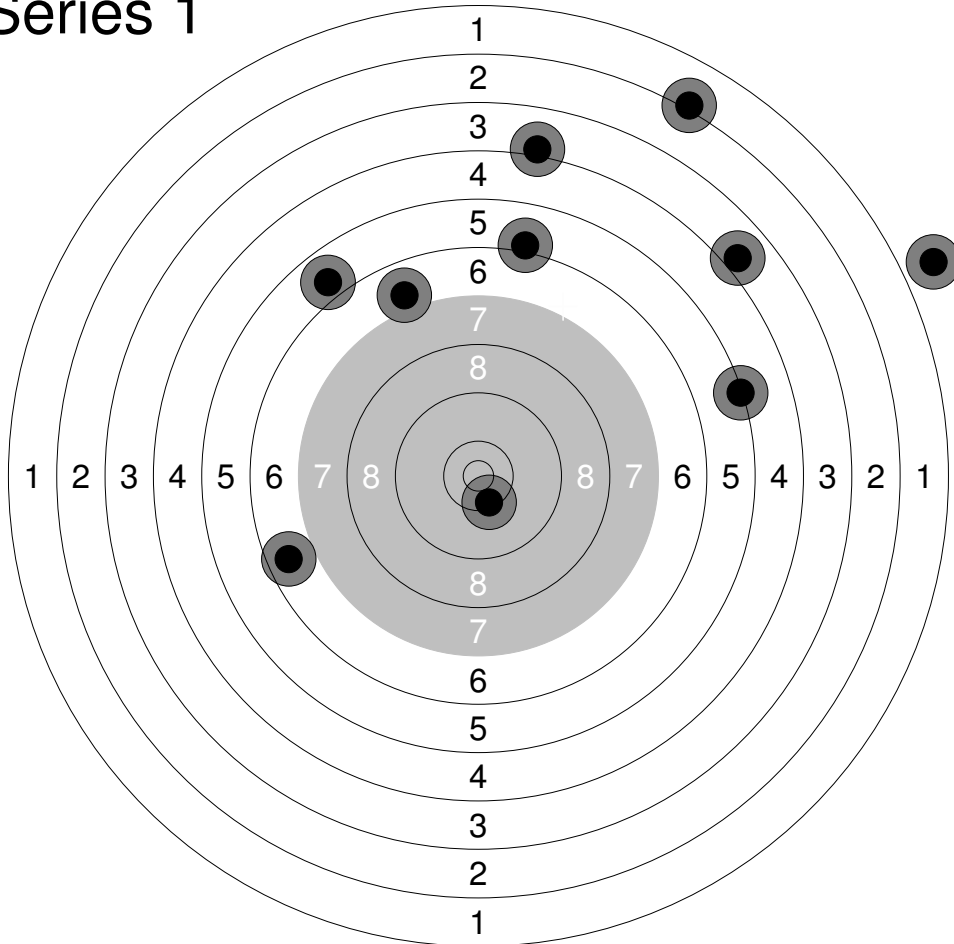

1:	3.9	↗
2:	2.1	↗
3:	5.3	→
4:	5.9	↖
5:	6.9	↖
6:	6.1	↖
7:	4.1	↖
8:	6.7	↖
9:	10.4	↘
10:	0.0	↗

Series	47.0
Total	47.0

Series 2

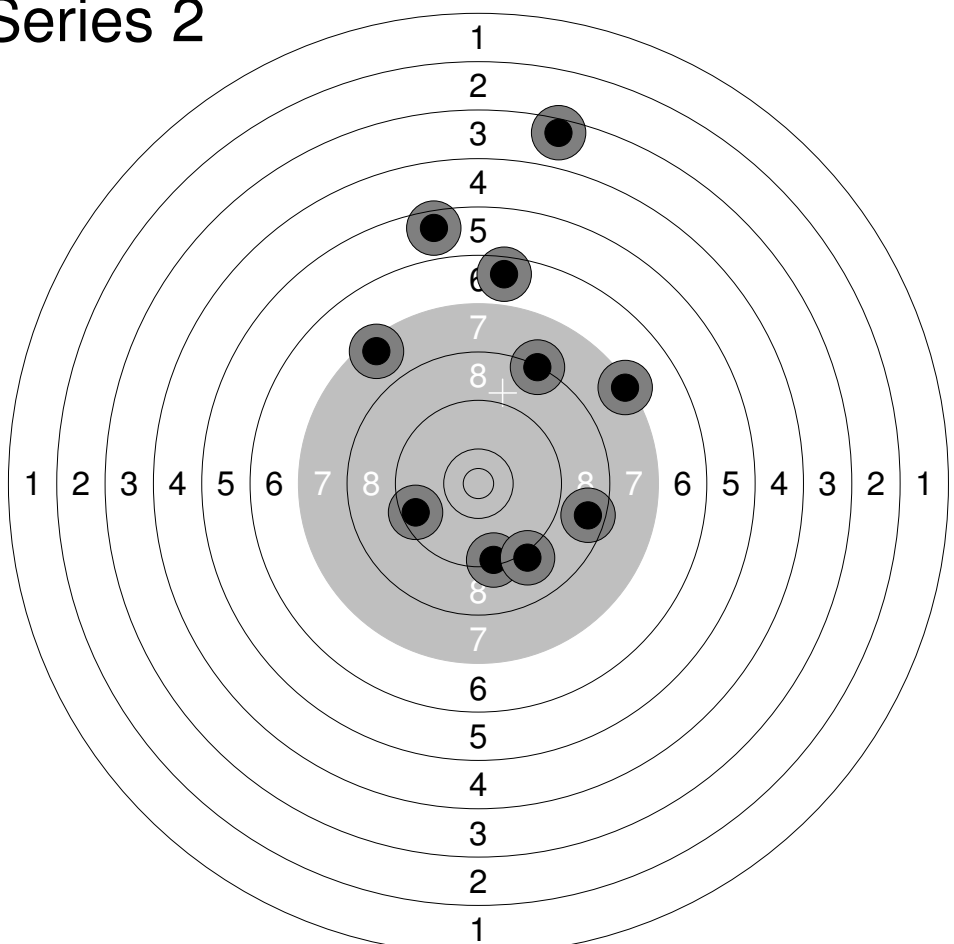

11:	8.3	↗
12:	8.6	→
13:	5.6	↖
14:	9.5	↖
15:	6.6	↖
16:	9.3	↘
17:	3.5	↖
18:	7.3	↗
19:	7.5	↖
20:	9.1	↘

Series	71.0
Total	118.0

Series 1

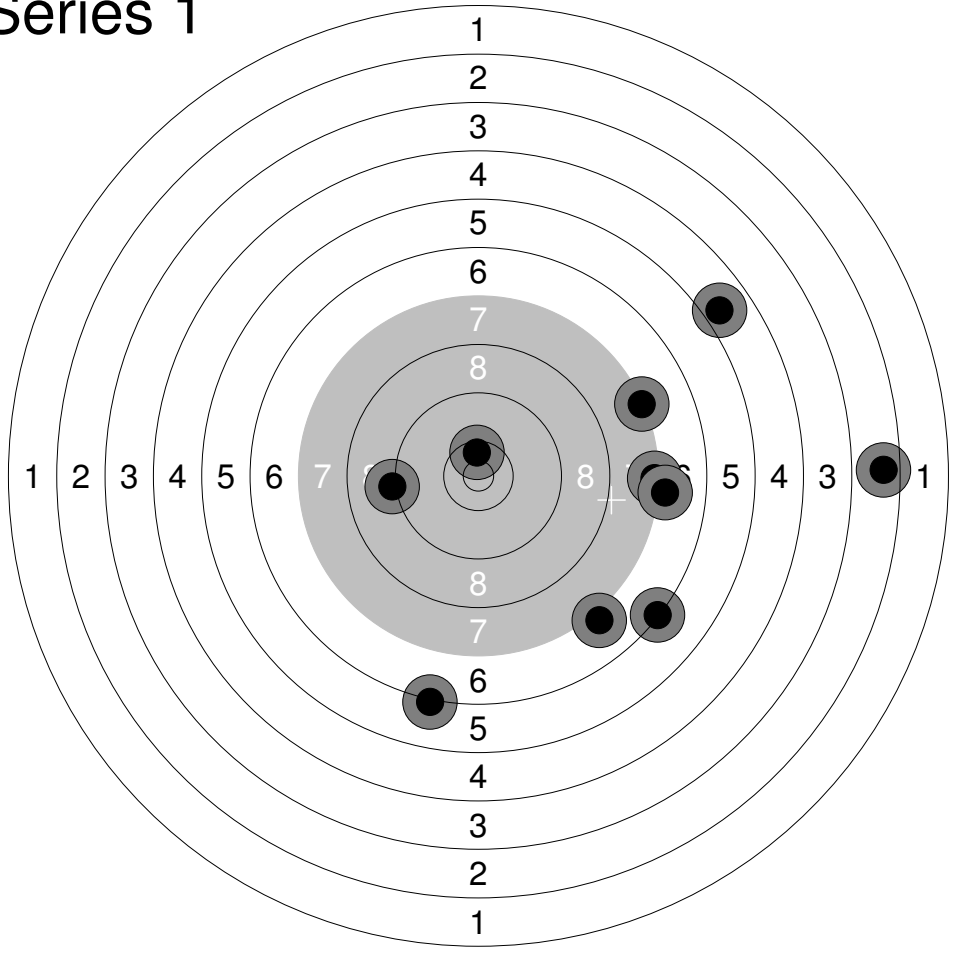

1:	7.3	→
2:	6.2	↓
3:	4.9	↗
4:	7.1	→
5:	7.1	↘
6:	6.3	↘
7:	2.6	→
8:	9.2	←
9:	10.5x	↑
10:	7.3	↗

Series	65.0
Total	65.0

Series 2

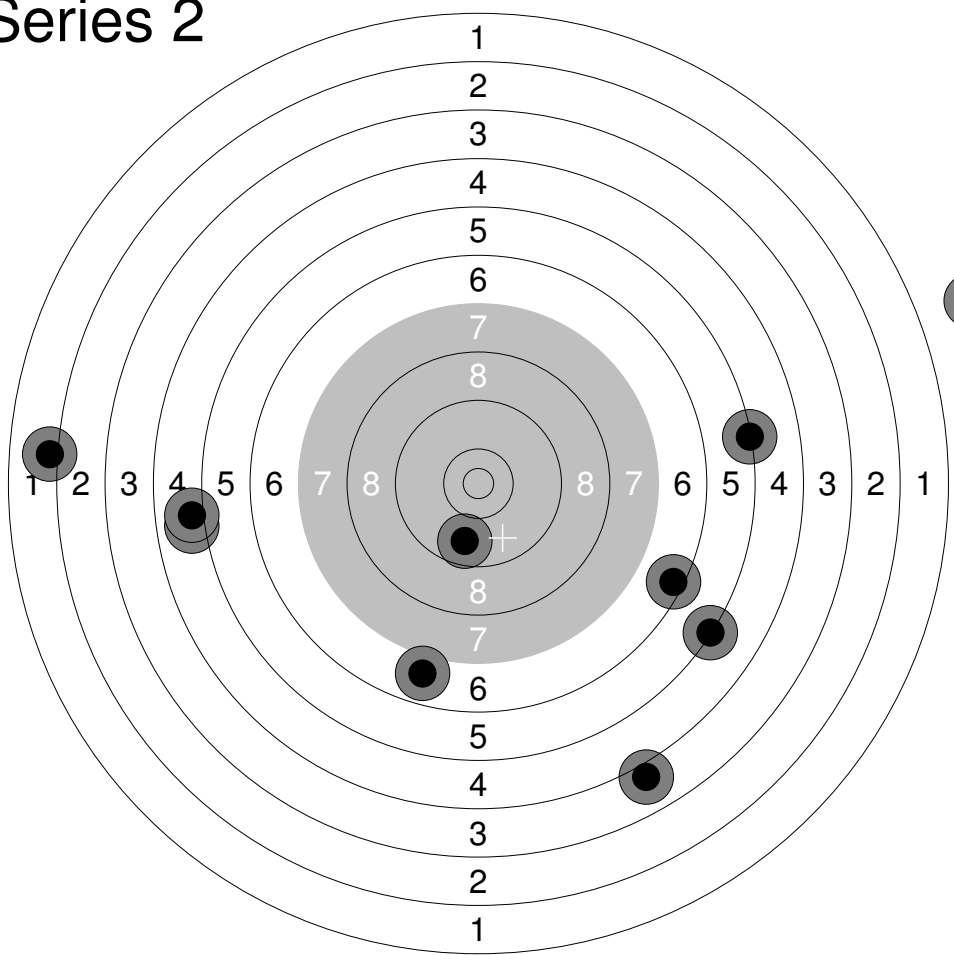

11:	5.3	↘
12:	5.0	←
13:	6.4	↘
14:	6.9	↓
15:	5.0	←
16:	5.3	→
17:	4.0	↘
18:	9.7	↘
19:	2.1	←
20:	0.0	→

Series	47.0
Total	112.0

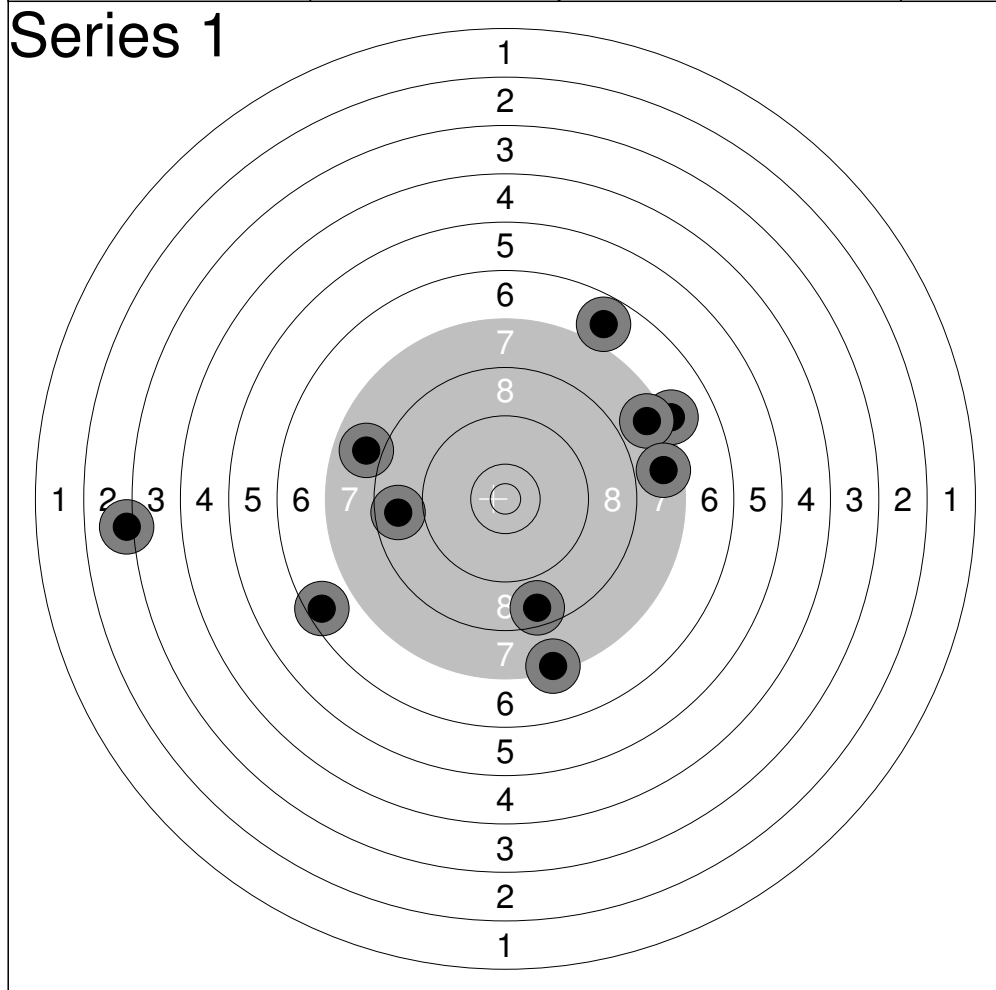

1:	8.6	↓
2:	7.9	↖
3:	7.4	↓
4:	6.5	↖
5:	3.1	↖
6:	7.1	↗
7:	8.7	↖
8:	7.6	↗
9:	6.8	↗
10:	7.6	↗

Series	66.0
Total	66.0

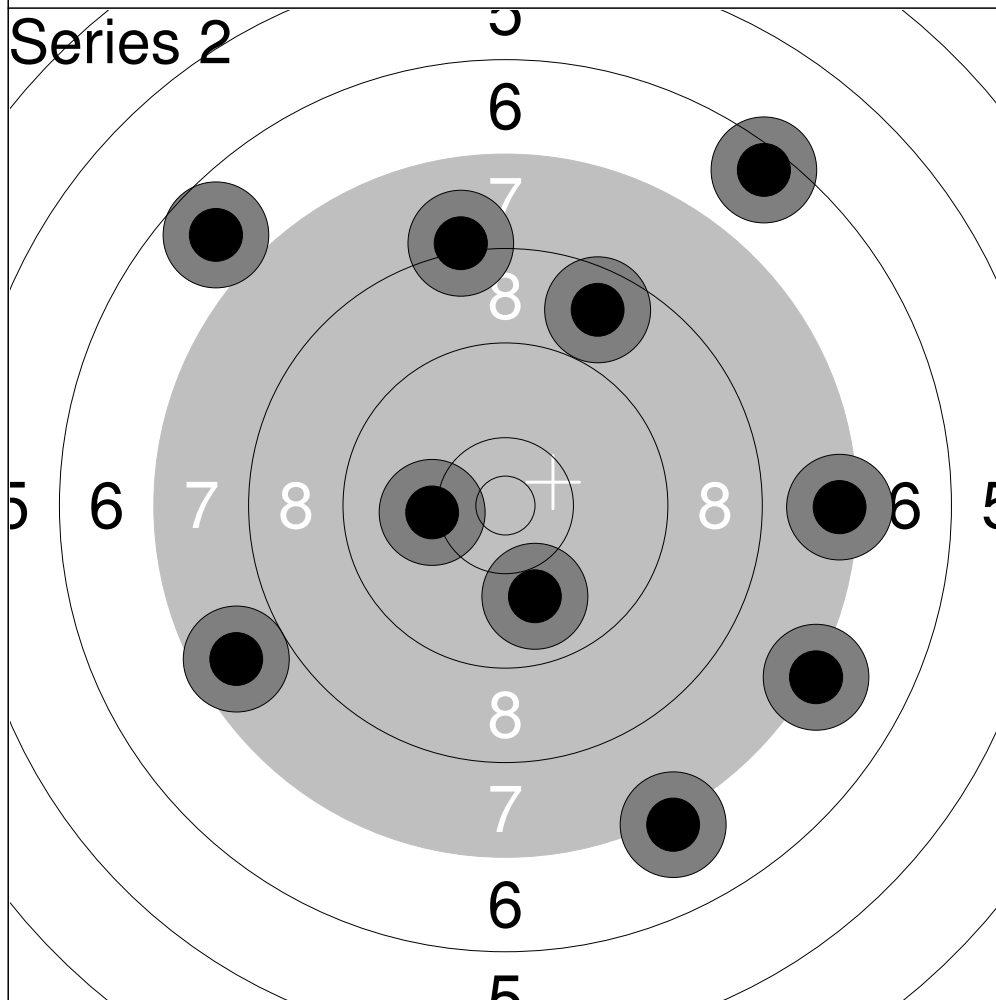

11:	10.2	↖
12:	8.1	↑
13:	6.8	↖
14:	6.5	↗
15:	7.4	→
16:	7.1	↓
17:	7.7	↖
18:	7.2	↘
19:	9.9	↓
20:	8.7	↗

Series	75.0
Total	141.0

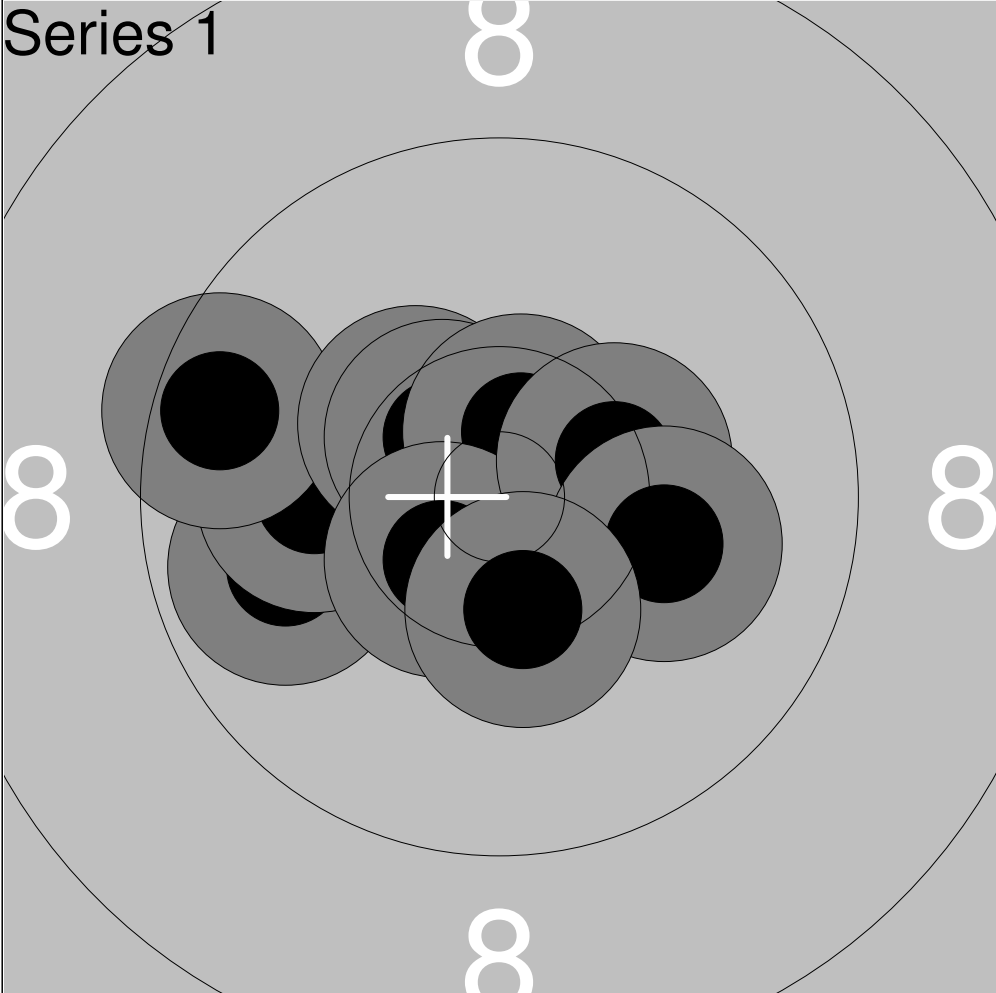
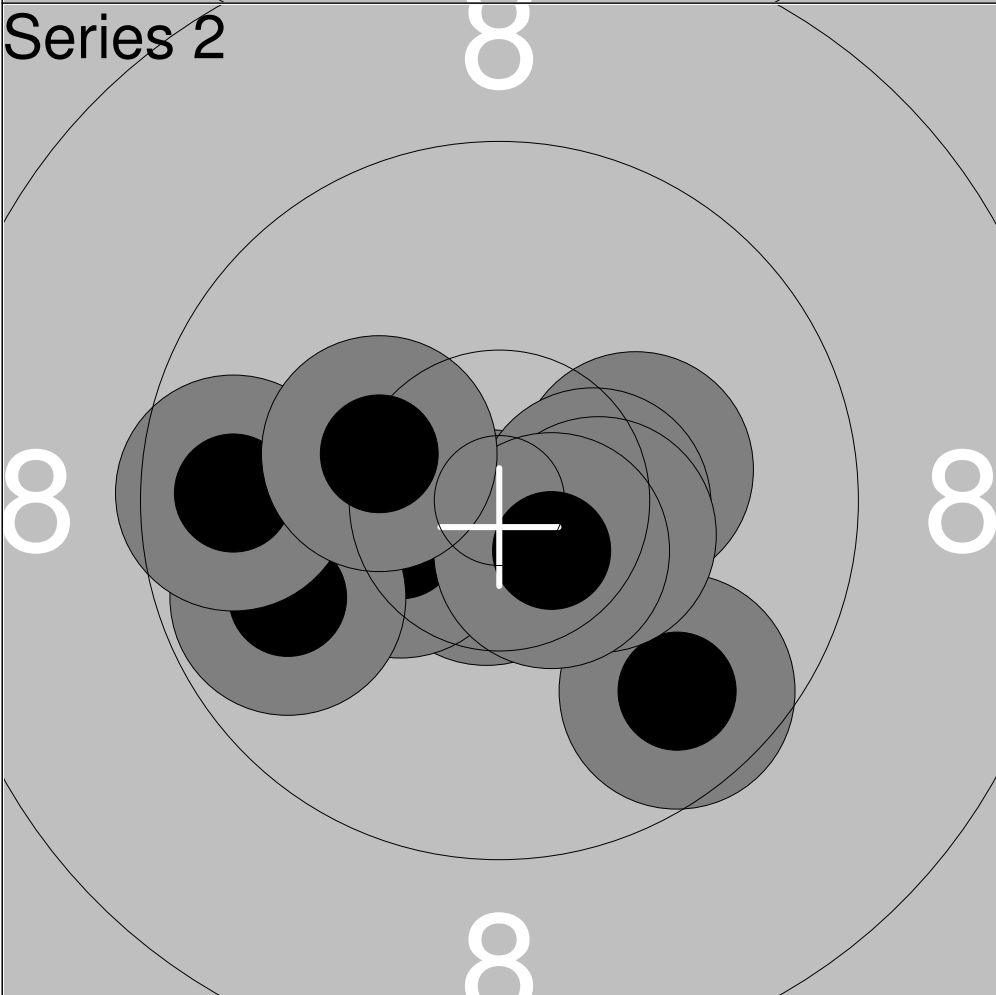
Relay	Lane	Juha-Pekka Vähätalo.		
Air	KaA	AP IT10		
8.-9.2.2014	Aluemestaruuskilpailut	Kankaanpään Ampumaurheilijat		
Series 1 	1:	9.9	←	
	2:	10.1	←	
	3:	9.5	↖	
	4:	10.4x	↗	
	5:	10.6x	↗	
	6:	10.6x	↗	
	7:	10.6x	↙	
	8:	10.4x	→	
	9:	10.1	→	
	10:	10.4x	↓	
	Series	98.0		
	Total	98.0		
Series 2 	11:	10.3	→	
	12:	10.7x	↓	
	13:	9.7	↘	
	14:	10.4x	←	
	15:	9.8	←	
	16:	9.7	←	
	17:	10.5x	→	
	18:	10.5x	→	
	19:	10.6x	↘	
	20:	10.3	↖	
	Series	97.0		
	Total	195.0		

Relay 11	Lane 14	Jesse Holma
--------------------	-------------------	--------------------

Air	KaA	AP IT10
-----	-----	---------

8.-9.2.2014	Aluemestaruuskilpailut	Kankaanpään Ampumaurheilijat
-------------	------------------------	------------------------------

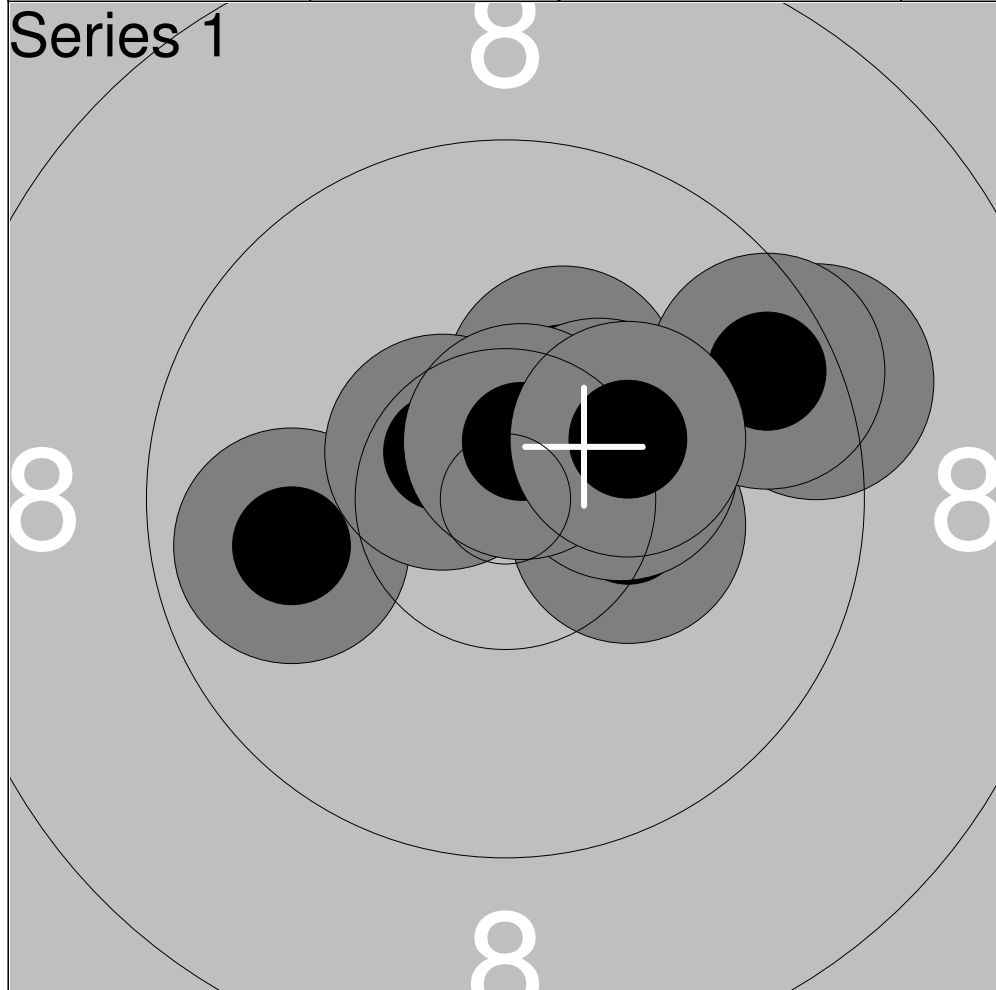

1:	9.9	←
2:	9.4	→
3:	10.3	↗
4:	10.3	→
5:	10.6x	↖
6:	9.6	→
7:	10.4x	↗
8:	10.4x	→
9:	10.7x	↗
10:	10.3	→

Series	97.0
Total	97.0

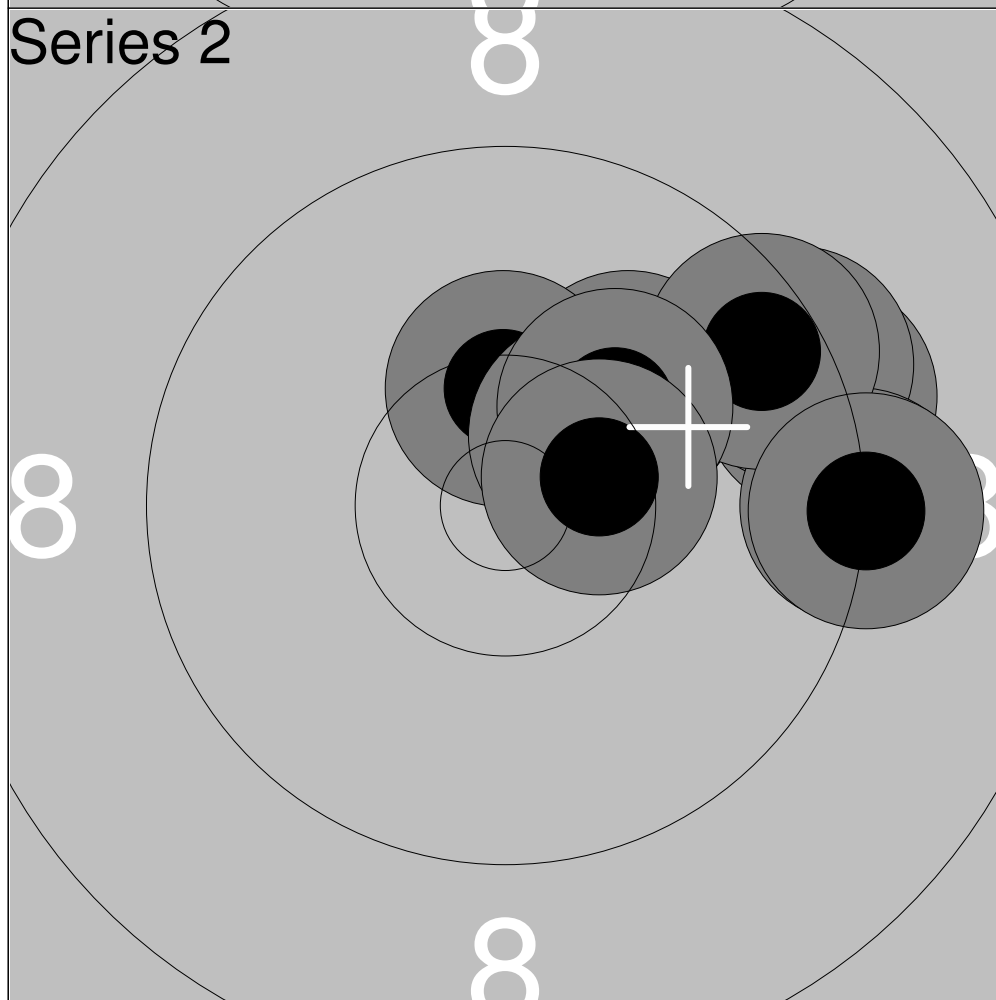

11:	9.4	→
12:	9.4	→
13:	10.1	↗
14:	10.4x	↑
15:	10.4x	↗
16:	9.3	→
17:	9.5	↗
18:	9.2	→
19:	10.2	↗
20:	10.5x	→

Series	95.0
Total	192.0

Relay 11	Lane 17	Aleksi Kauppila.	
--------------------	-------------------	-------------------------	--

Air	KaA	AP IT10
-----	-----	---------

8.-9.2.2014	Aluemestaruuskilpailut	Kankaanpään Ampumaurheilijat
-------------	------------------------	------------------------------

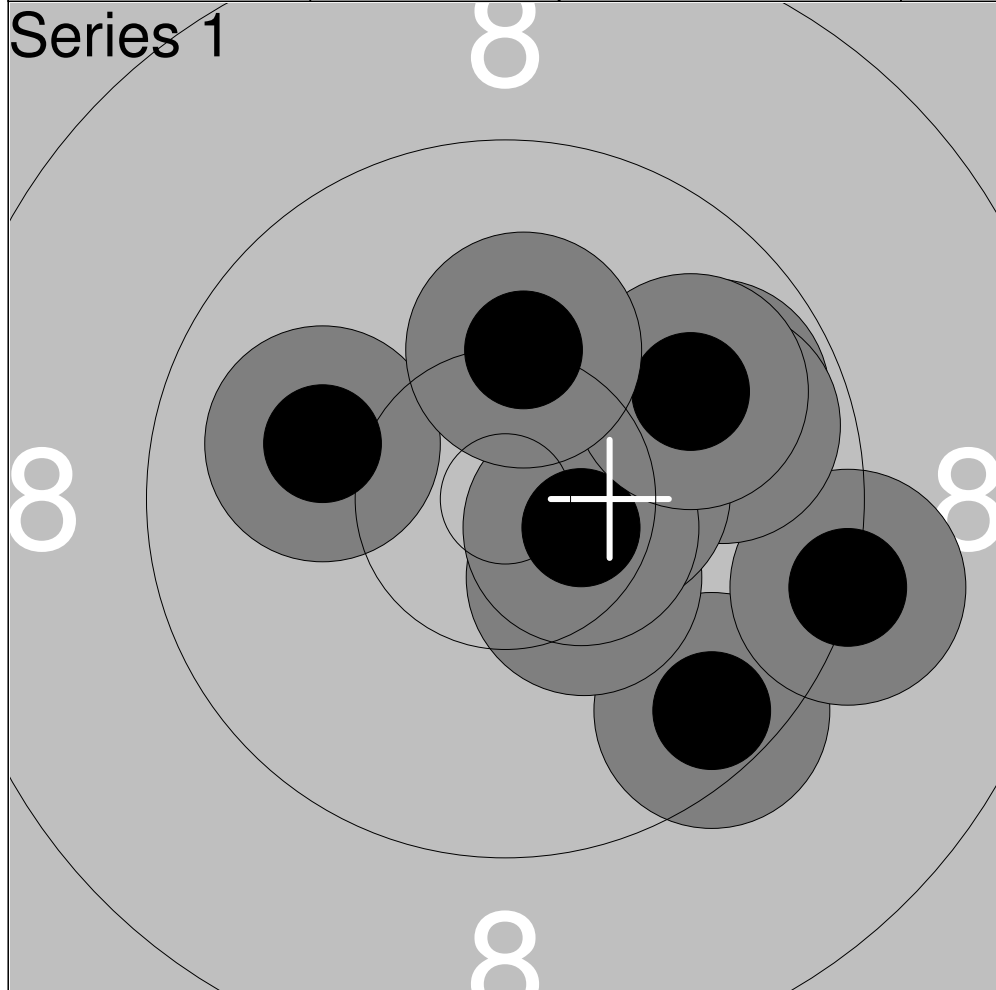

1:	9.5	↘
2:	10.4x	↘
3:	9.8	↗
4:	9.3	↗
5:	10.0	↖
6:	9.9	↗
7:	10.4x	→
8:	10.6x	↗
9:	9.9	↗
10:	10.2	↑

Series	95.0
Total	95.0

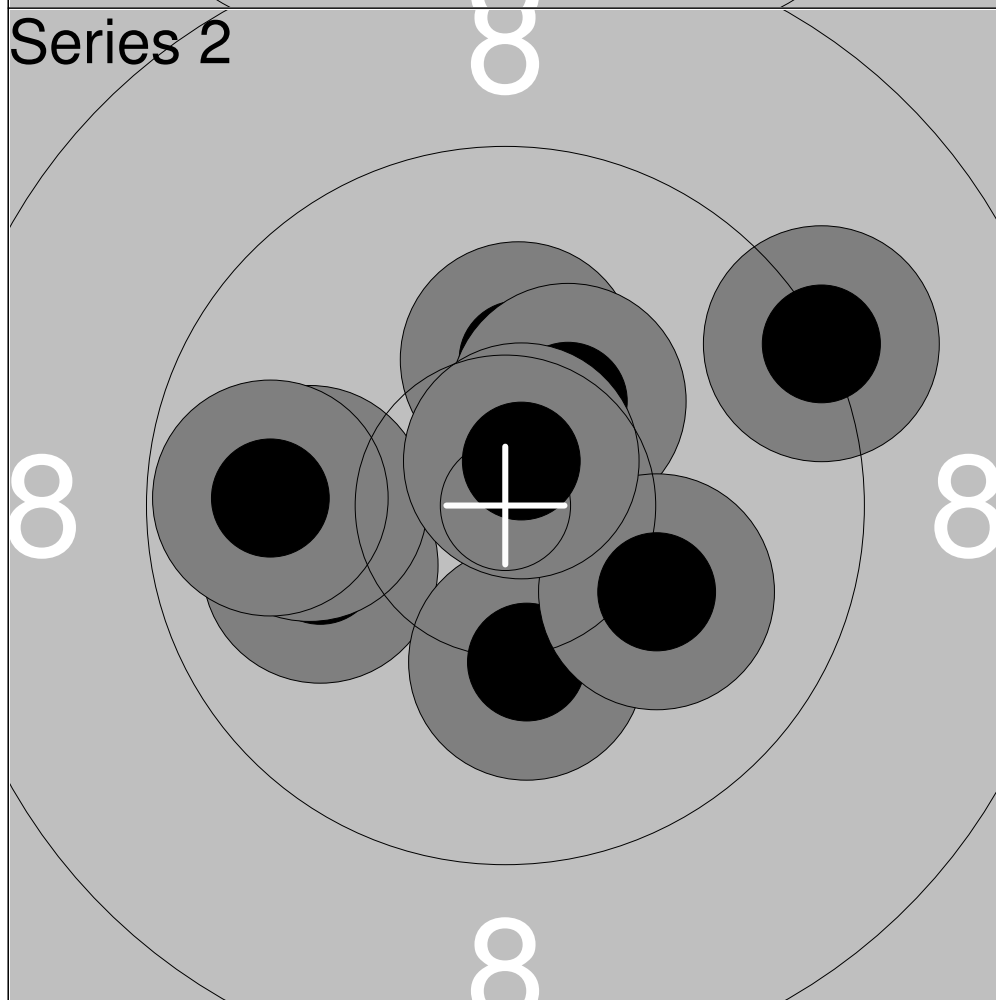

11:	9.3	↗
12:	10.5x	↑
13:	10.3	↑
14:	10.0	↖
15:	10.4x	↗
16:	10.0	↖
17:	10.2	↘
18:	10.1	↘
19:	10.7x	↑
20:	9.8	↖

Series	98.0
Total	193.0

Series 1

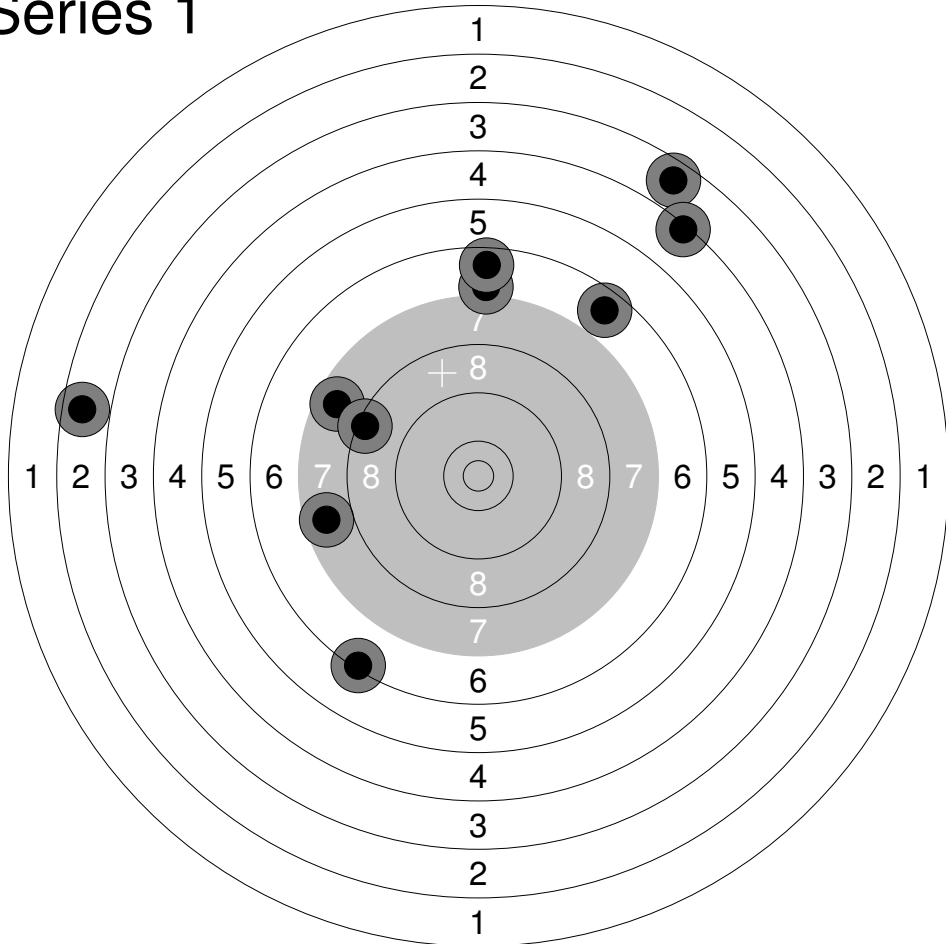

1:	6.3	↘
2:	3.6	↗
3:	6.7	↗
4:	7.7	←
5:	4.3	↗
6:	7.0	↑
7:	7.7	↖
8:	8.4	↖
9:	6.6	↑
10:	2.7	←

Series	56.0
Total	56.0

Series 2

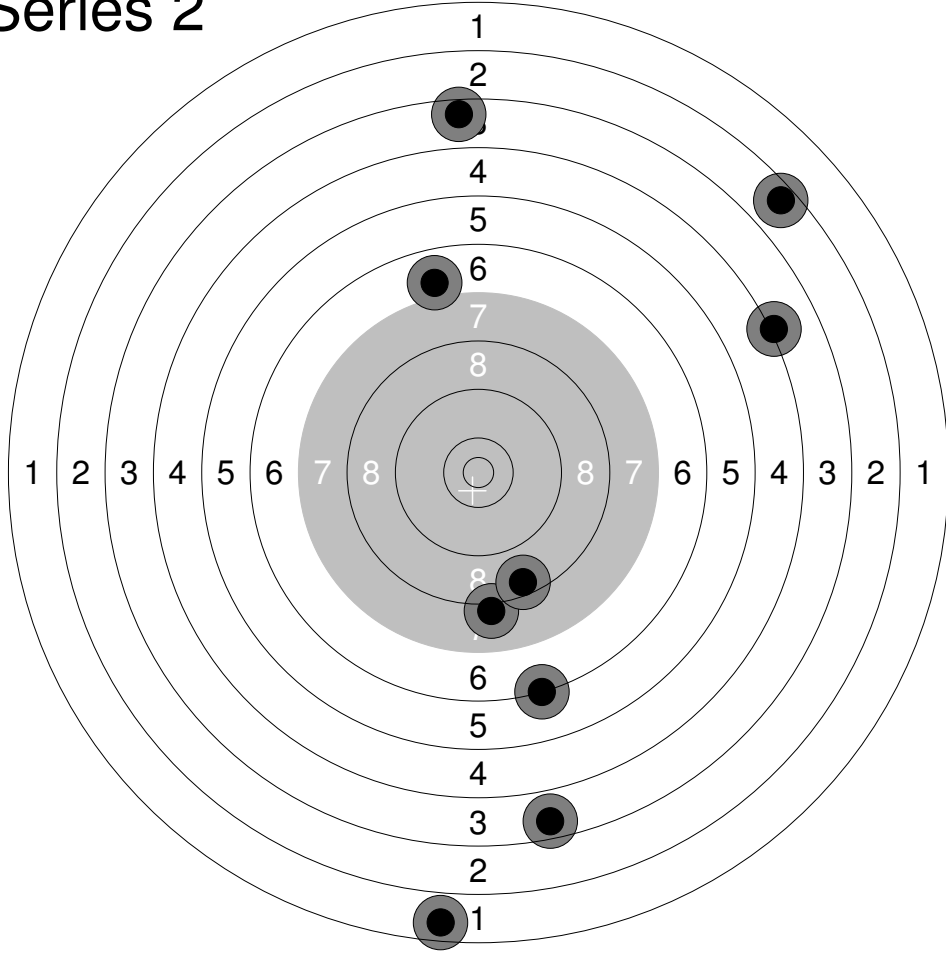

11:	0.0	←
12:	3.5	↑
13:	6.9	↑
14:	4.2	↗
15:	3.6	↓
16:	6.2	↓
17:	2.5	↗
18:	1.6	↓
19:	8.1	↓
20:	8.5	↓

Series	41.0
Total	97.0

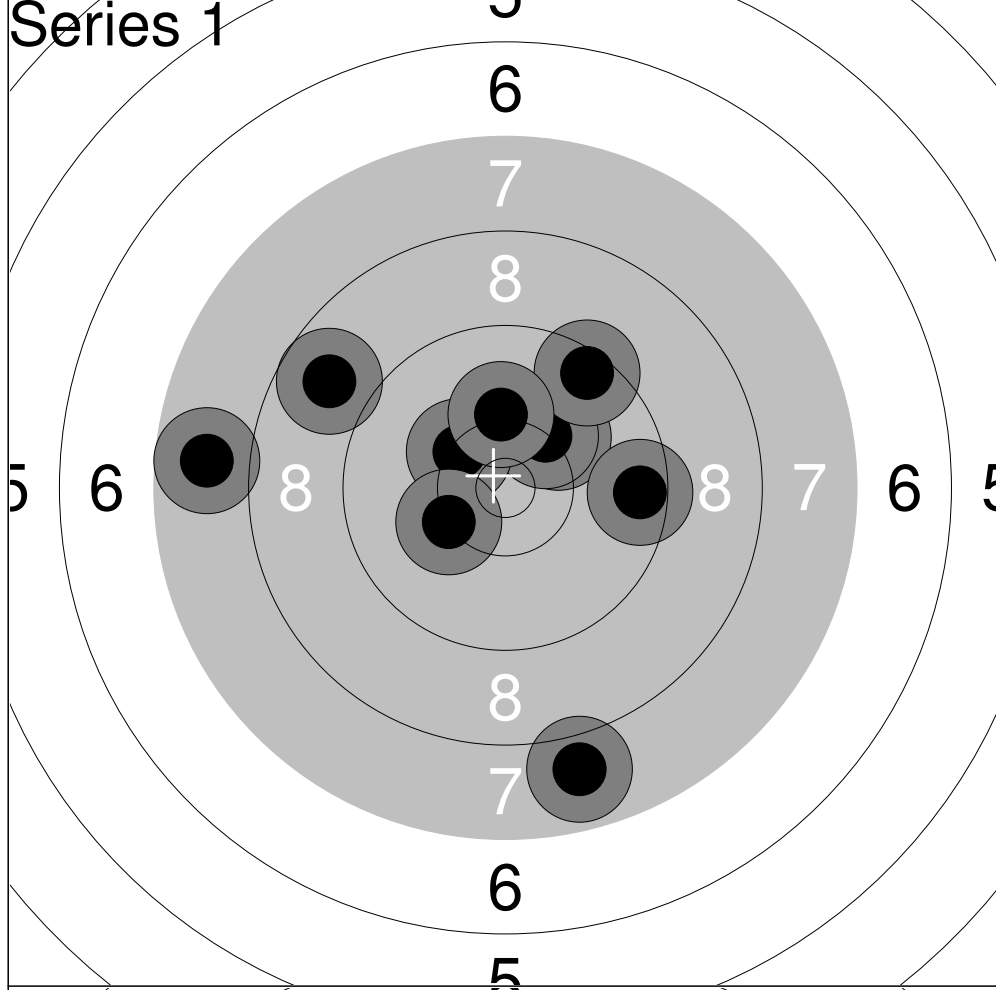

1:	10.2	↗
2:	10.3	↗
3:	8.8	↖
4:	9.5	↗
5:	10.3	↖
6:	9.5	→
7:	7.9	↓
8:	7.8	←
9:	10.2	↑
10:	10.3	↙

Series	90.0
Total	90.0

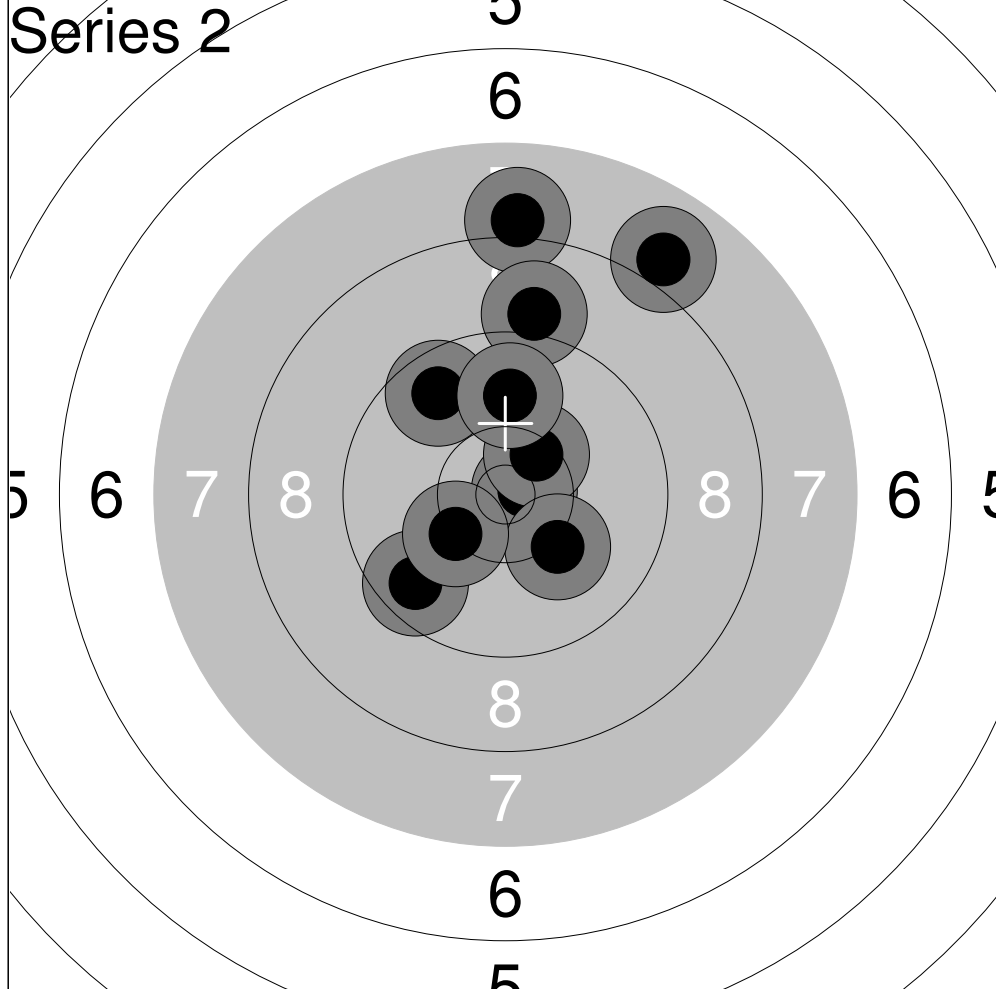

11:	8.1	↑
12:	10.7x	→
13:	9.6	↙
14:	9.0	↑
15:	9.7	↖
16:	10.4x	↗
17:	7.9	↗
18:	10.2	↘
19:	10.3	↙
20:	9.9	↑

Series	91.0
Total	181.0