

1: 9.1 →	6: 9.6 ↖	<b>Series</b> 97.0
2: 10.7x →	7: 10.3x ←	
3: 10.0 ↓	8: 9.9 ↓	<b>Total</b> 97.0
4: 10.3x ↙	9: 10.3x ↓	
5: 10.3x ↗	10: 10.2x ↗	

11: 10.9x ↓	16: 10.3x ←	<b>Series</b> 99.0
12: 10.4x ↙	17: 10.1 ↖	
13: 10.1 ↓	18: 10.1 ↗	<b>Total</b> 196.0
14: 10.4x ↖	19: 9.3 →	
15: 10.8x ↙	20: 10.7x ↓	

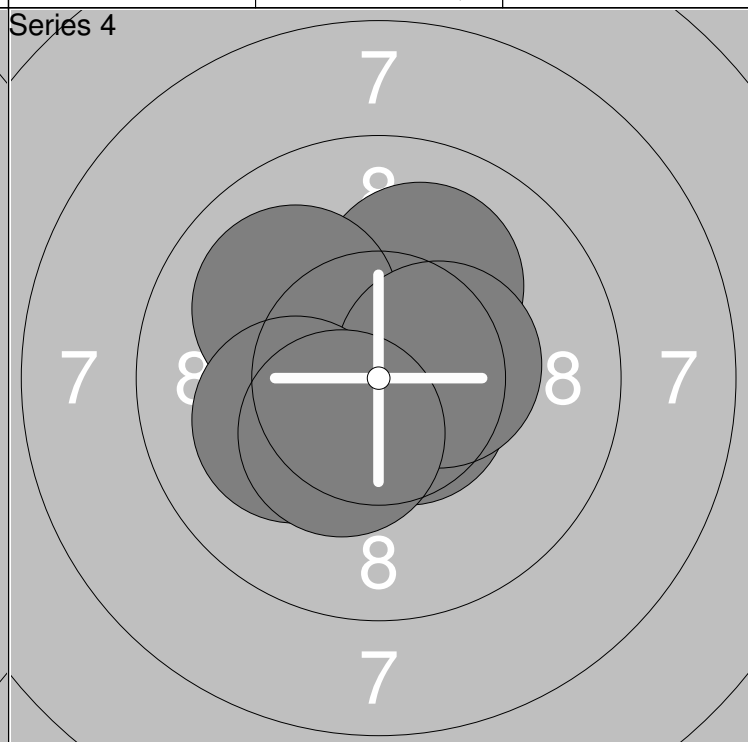
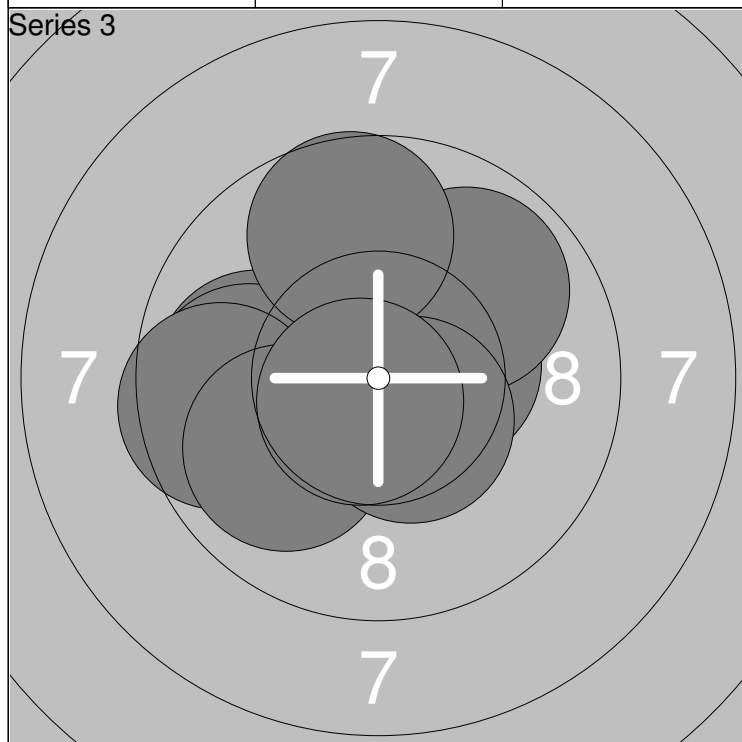

21: 10.2x ←	26: 9.6 ←	<b>Series</b> 95.0
22: 10.4x →	27: 9.7 ↗	
23: 9.9 ←	28: 10.0 ↙	<b>Total</b> 291.0
24: 9.8 ←	29: 10.5x ↓	
25: 9.9 ↗	30: 10.7x ↙	

31: 10.7x ↖	36: 10.6x ↓	<b>Series</b> 100.0
32: 10.8x ↓	37: 10.0 ↖	
33: 10.4x →	38: 10.4x →	<b>Total</b> 391.0
34: 10.1 ↗	39: 10.2x ←	
35: 10.7x →	40: 10.4x ↙	

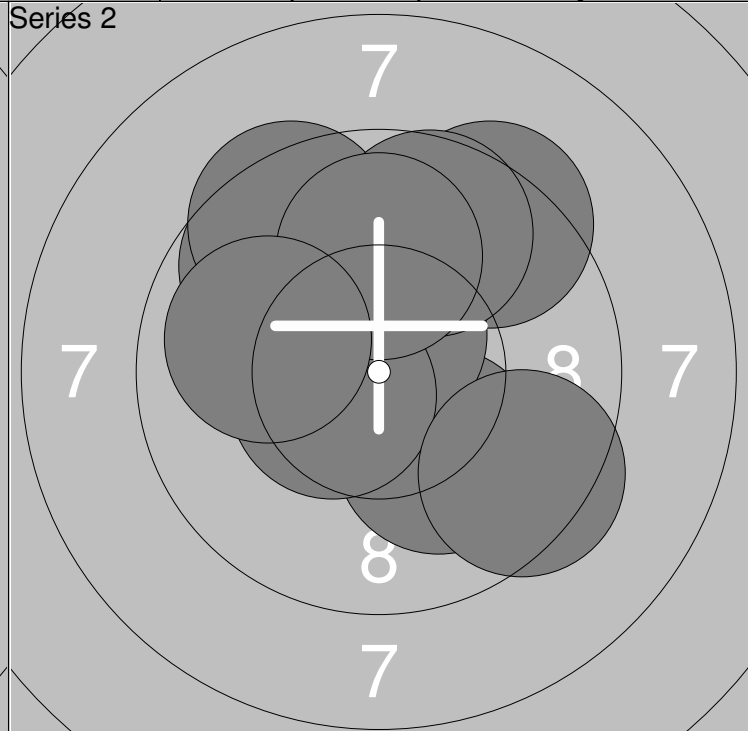
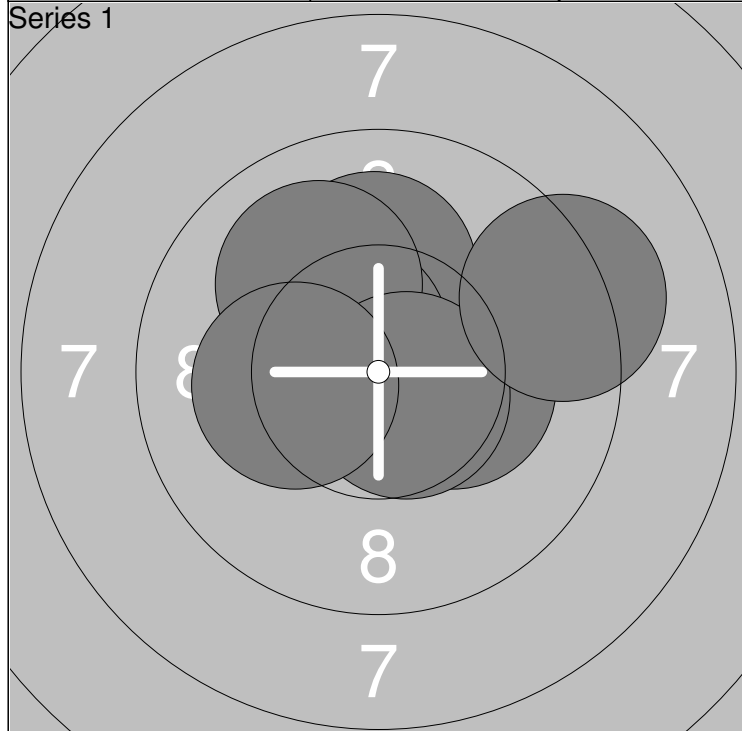

1: 10.5x →	6: 10.6x ↗	Series	99.0
2: 10.5x ↗	7: 10.0 ↗		
3: 10.3x →	8: 10.6x ↘	Total	99.0
4: 10.5x ↑	9: 10.2x ←		
5: 10.1 ↑	10: 9.2 →		

11: 9.4 ↗	16: 10.5x ←	Series	94.0
12: 10.1 ↘	17: 9.4 ↘		
13: 10.6x ↑	18: 9.7 ↑	Total	193.0
14: 9.7 ↗	19: 10.0 ↑		
15: 9.5 ↗	20: 9.9 ←		

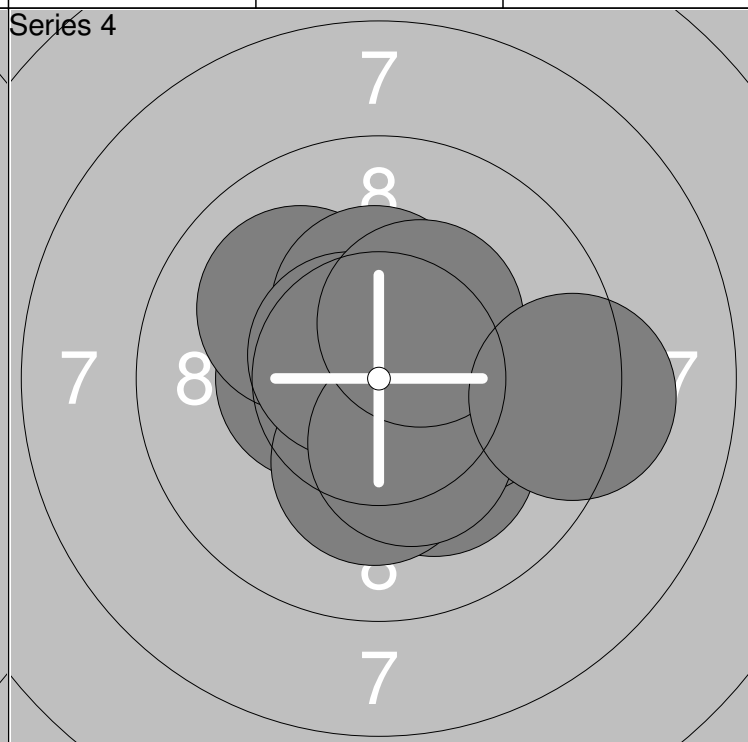
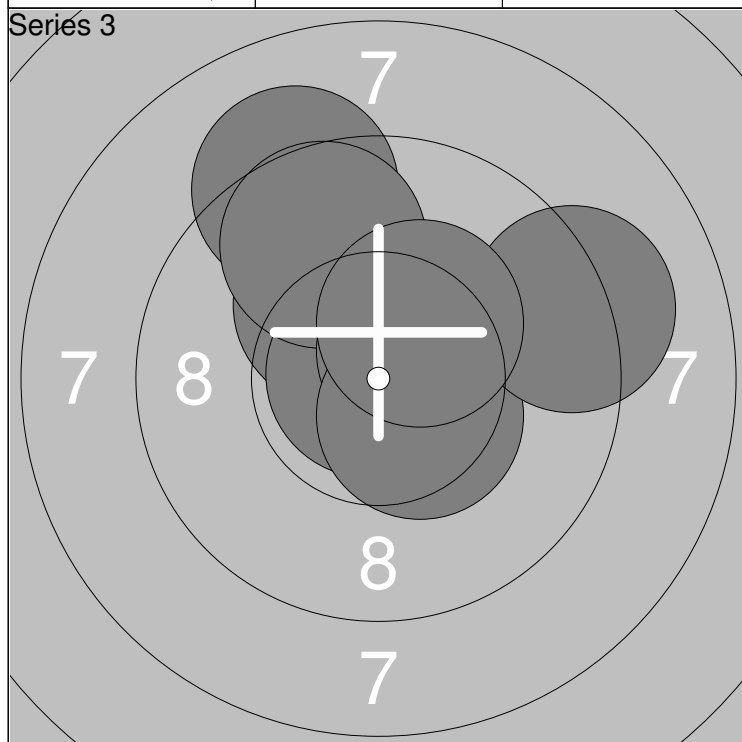

21: 10.5x ↑	26: 9.7 ↗	Series	97.0
22: 10.2x ↗	27: 10.5x ↗		
23: 10.2x ↗	28: 10.5x ↘	Total	290.0
24: 10.9x ←	29: 9.2 →		
25: 9.2 ↗	30: 10.4x ↗		

31: 10.2x ↘	36: 10.6x ↗	Series	99.0
32: 10.4x ←	37: 10.2x →		
33: 10.2x ↘	38: 10.3x ↘	Total	389.0
34: 10.1 ↗	39: 10.4x ↗		
35: 10.3x ↑	40: 9.3 →		

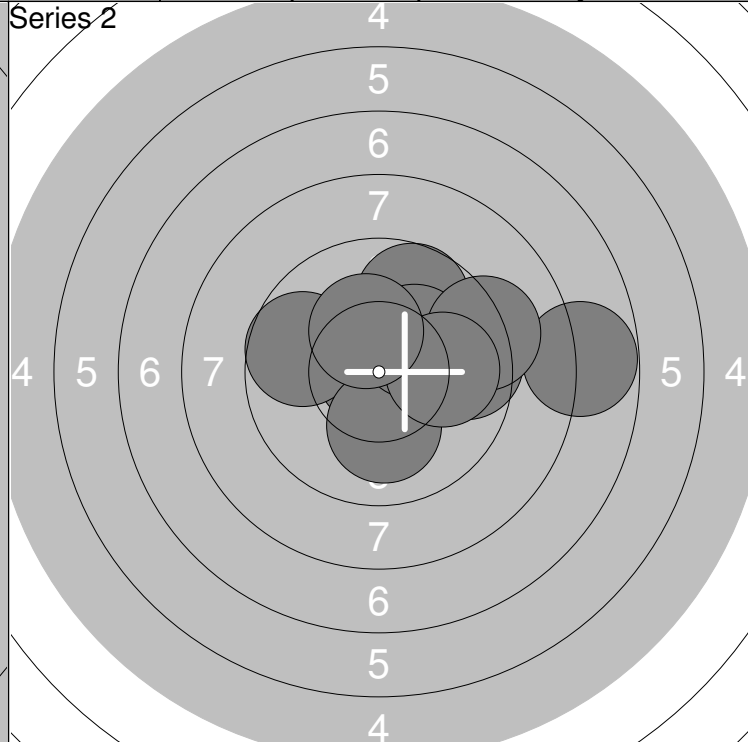
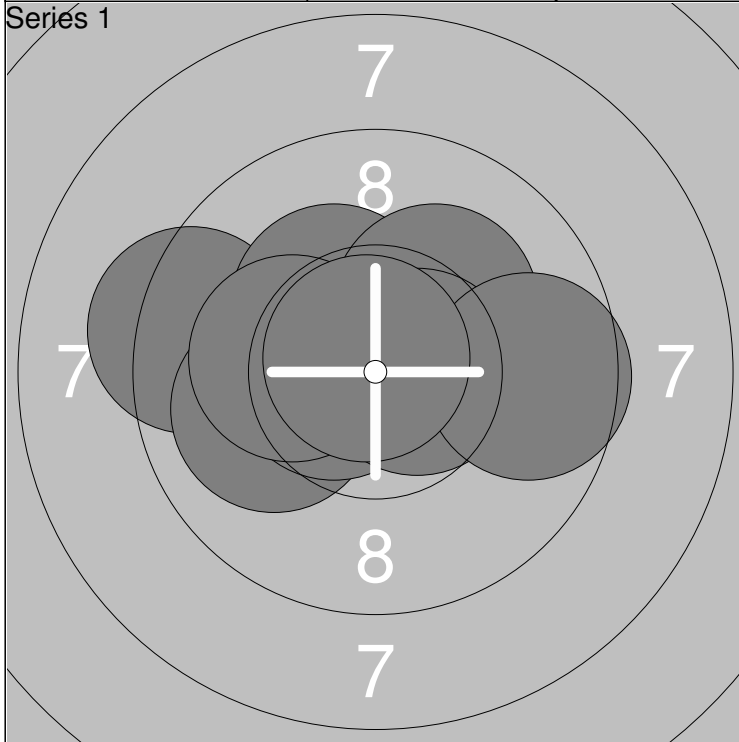

1: 9.3 ←	6: 10.2x ←	Series	98.0
2: 10.4x ↗	7: 10.2x ↗		
3: 10.3x ↖	8: 10.6x →	Total	98.0
4: 10.0 ←	9: 9.6 →		
5: 10.6x ←	10: 10.8x ↖		

11: 7.8 →	16: 10.1 ↓	Series	93.0
12: 10.8x ↖	17: 10.2x ↗		
13: 9.6 →	18: 9.2 ↗	Total	191.0
14: 9.7 ↗	19: 10.0 →		
15: 9.7 ←	20: 10.3x ↖		

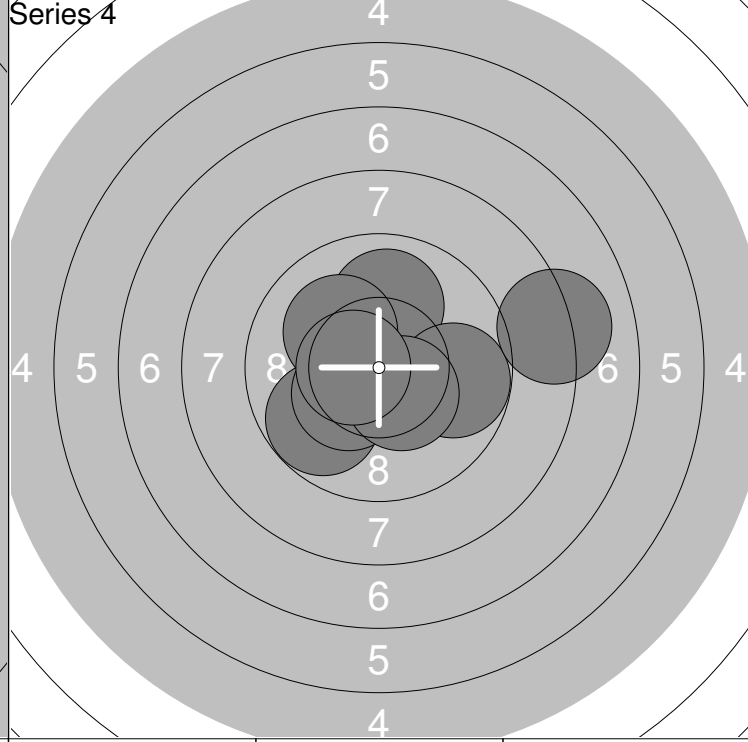
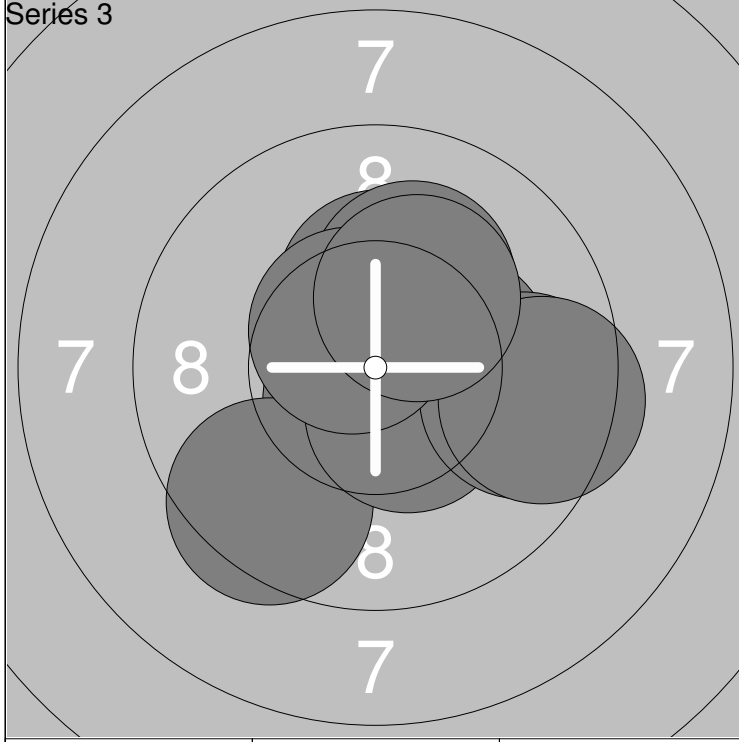

21: 10.6x ↓	26: 10.5x ↘	Series	97.0
22: 10.3x →	27: 9.7 →		
23: 10.3x ↑	28: 9.5 →	Total	288.0
24: 9.5 ↘	29: 10.6x ↗		
25: 10.2x ↗	30: 10.2x ↗		

31: 9.8 ↖	36: 10.1 ↗	Series	96.0
32: 10.6x ↖	37: 9.8 →		
33: 10.7x ←	38: 10.4x ↘	Total	384.0
34: 10.3x ↖	39: 10.5x ←		
35: 10.0 ↑	40: 8.1 →		

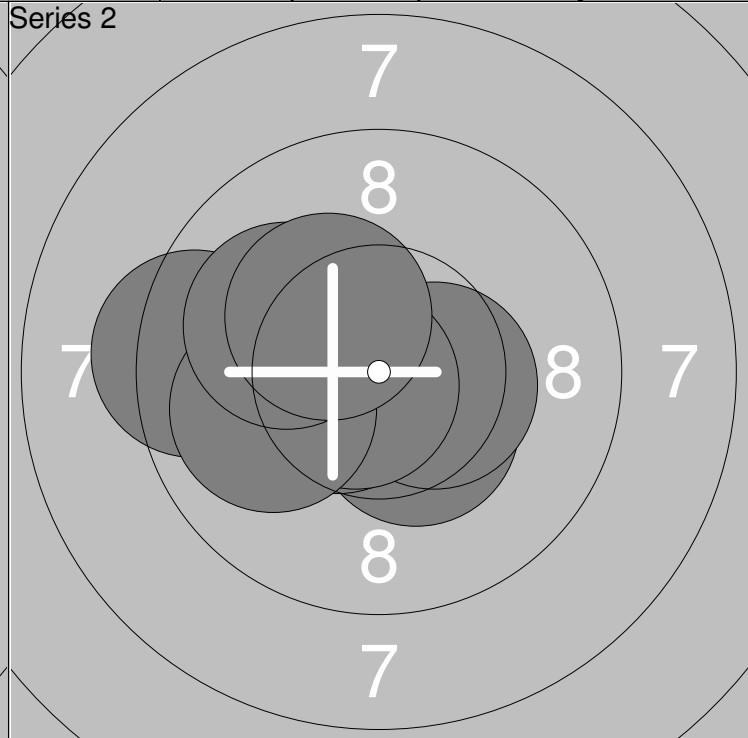
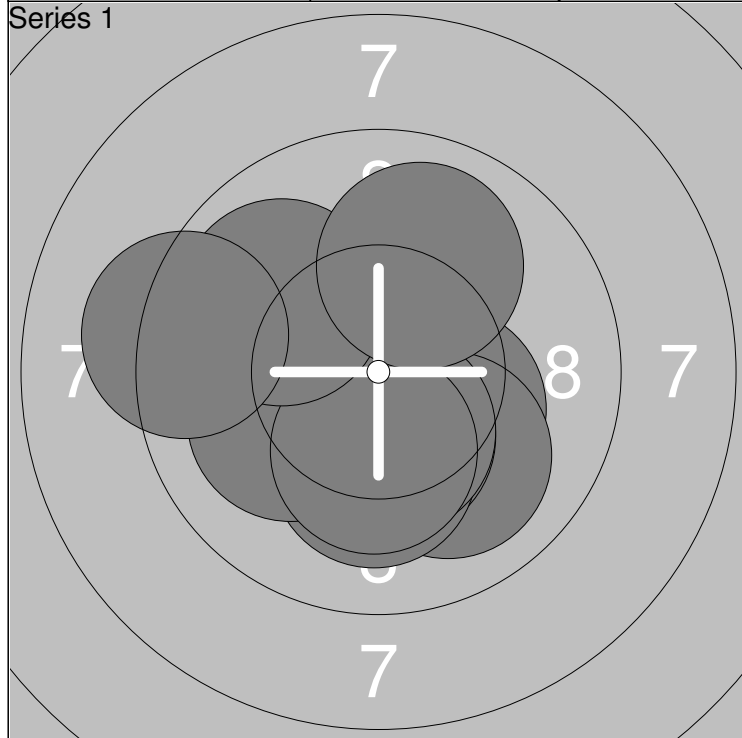

1: 10.3x ↘	6: 10.1 ↙	Series 98.0
2: 10.0 ↘	7: 10.3x ↓	
3: 10.4x ↓	8: 9.9 ↖	Total 98.0
4: 10.1 ↓	9: 10.0 ↗	
5: 10.4x ↓	10: 9.2 ←	

11: 10.4x ↘	16: 10.7x ↙	Series 99.0
12: 10.5x →	17: 9.3 ←	
13: 10.5x ↙	18: 10.0 ←	Total 197.0
14: 10.1 ↙	19: 10.1 ↙	
15: 10.1 ←	20: 10.3x ↘	

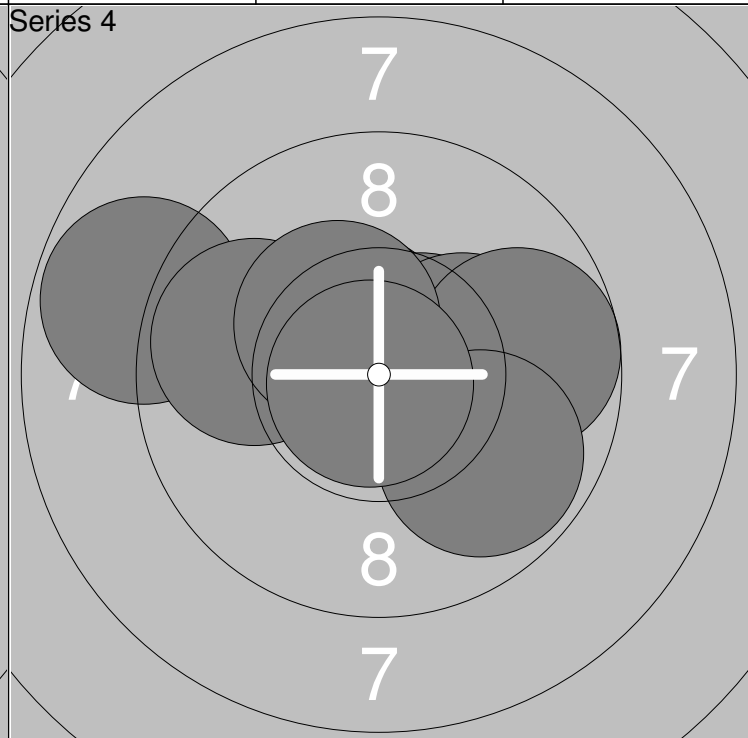
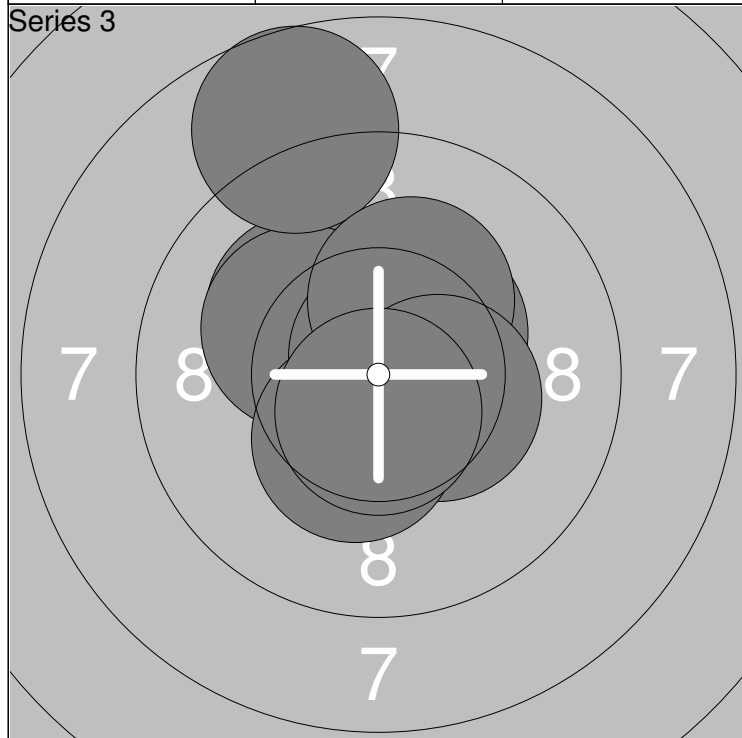

21: 10.4x ↗	26: 10.7x ↗	Series 98.0
22: 10.1 ↖	27: 10.3x ↗	
23: 10.4x ↗	28: 10.4x →	Total 295.0
24: 10.2x ↖	29: 10.3x ↓	
25: 8.7 ↗	30: 10.6x ↓	

31: 10.6x ↗	36: 9.7 →	Series 95.0
32: 8.8 ↖	37: 9.8 ←	
33: 10.4x ↖	38: 9.8 ↓	Total 390.0
34: 10.5x →	39: 10.4x ↖	
35: 10.2x →	40: 10.8x ↘	

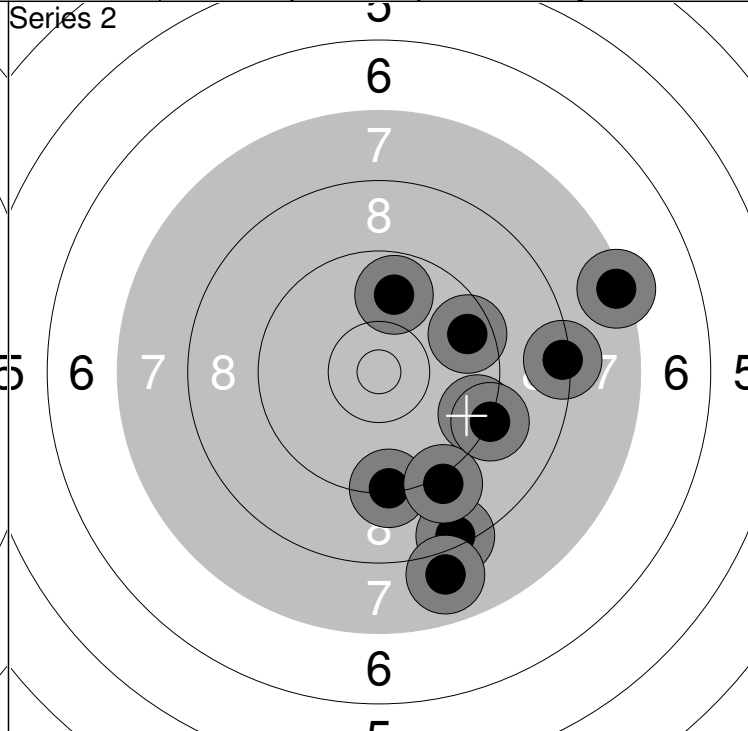
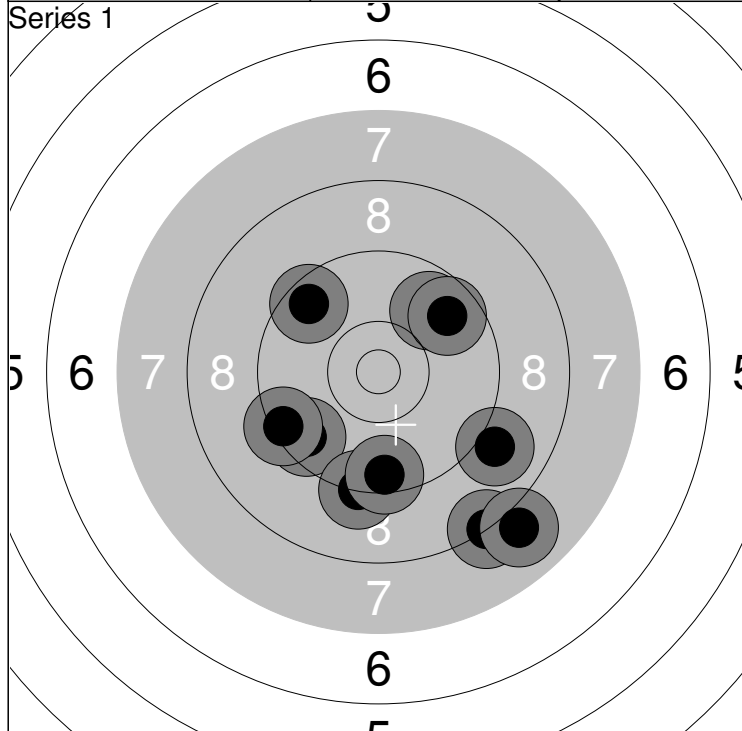

1: 9.8 ↗	6: 9.7 ↗	Series	88.0
2: 9.6 ↗	7: 9.5 ↓		Total
3: 9.6 ↙	8: 8.0 ↓		
4: 8.2 ↓	9: 9.0 ↘		
5: 9.3 ↓	10: 9.4 ↙		

11: 9.4 →	16: 9.3 ↓	Series	84.0
12: 8.4 ↓	17: 9.1 ↓		Total
13: 8.3 →	18: 7.9 ↓		
14: 9.8 ↑	19: 9.2 ↘		
15: 7.4 →	20: 9.6 ↗		

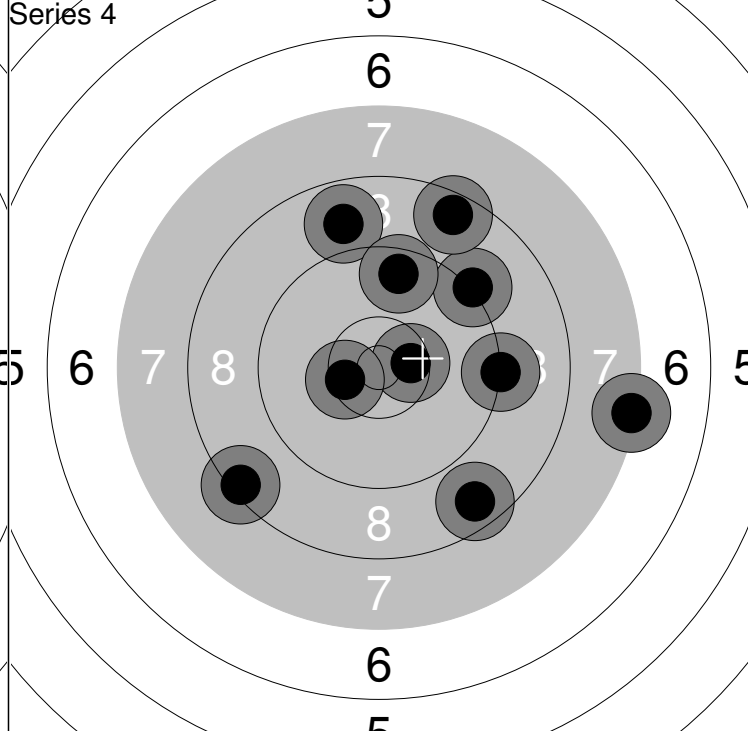
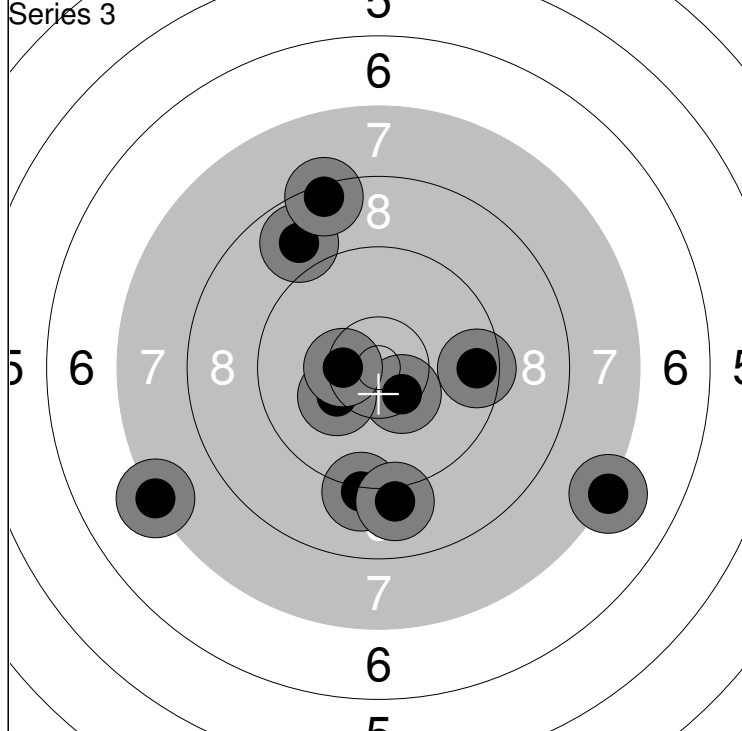

21: 9.2 ↓	26: 8.4 ↑	Series	87.0
22: 9.6 →	27: 10.2 ↙		Total
23: 10.4x ↘	28: 7.3 ↙		
24: 8.9 ↗	29: 7.2 ↘		
25: 9.0 ↓	30: 10.5x ←		

31: 9.2 →	36: 8.4 ↙	Series	86.0
32: 9.2 ↗	37: 10.4x ←		Total
33: 7.3 →	38: 8.8 ↑		
34: 8.6 ↓	39: 9.6 ↑		
35: 10.5x →	40: 8.5 ↗		

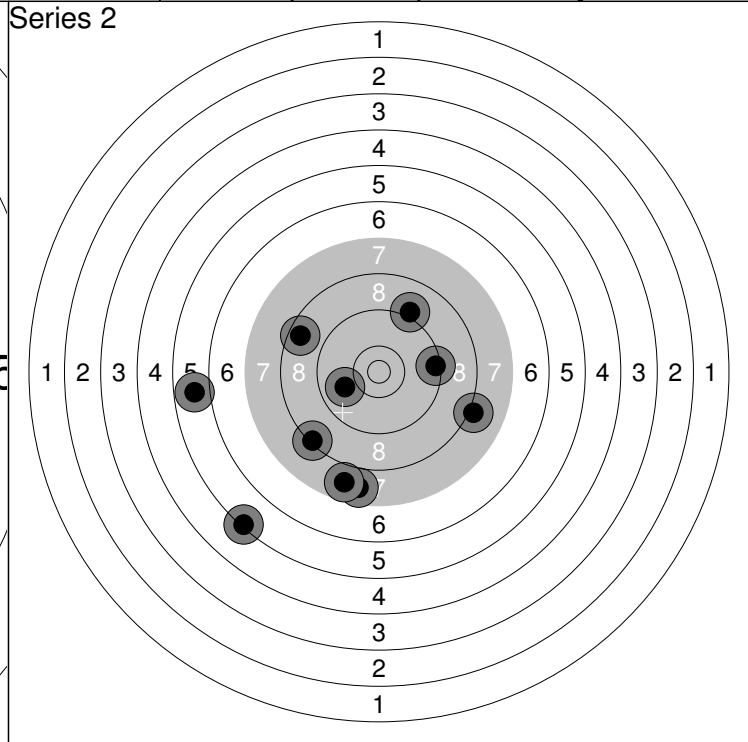
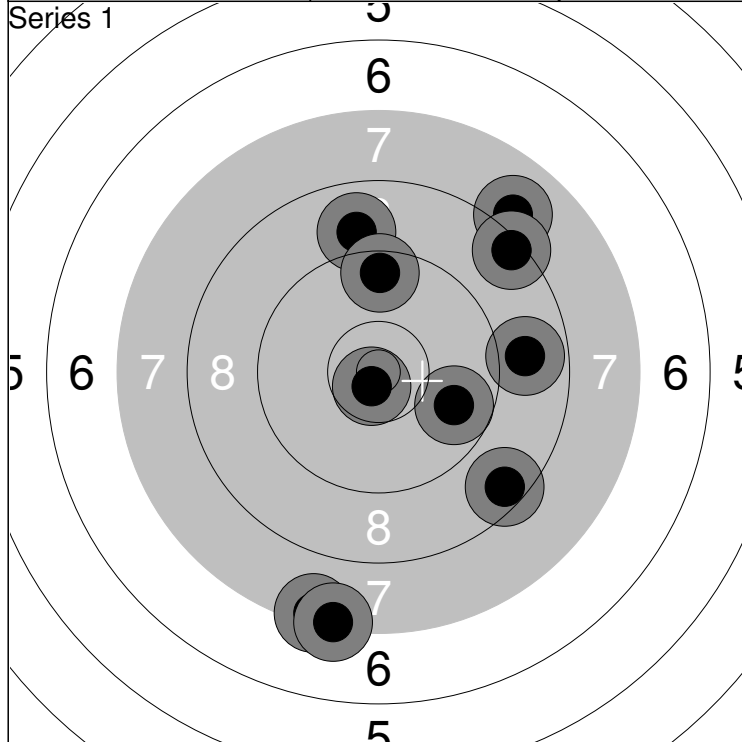

1: 8.0 ↗	6: 9.8 →	Series 82.0
2: 8.9 ↑	7: 7.3 ↓	
3: 8.5 ↘	8: 10.7x ↓	Total 82.0
4: 8.8 →	9: 9.5 ↑	
5: 7.4 ↓	10: 8.4 ↗	

11: 9.4 →	16: 8.5 ↖	Series 75.0
12: 8.1 →	17: 9.1 ↗	
13: 7.7 ↓	18: 8.3 ↖	Total 157.0
14: 7.7 ↓	19: 5.3 ↖	
15: 5.8 ←	20: 9.9 ↖	

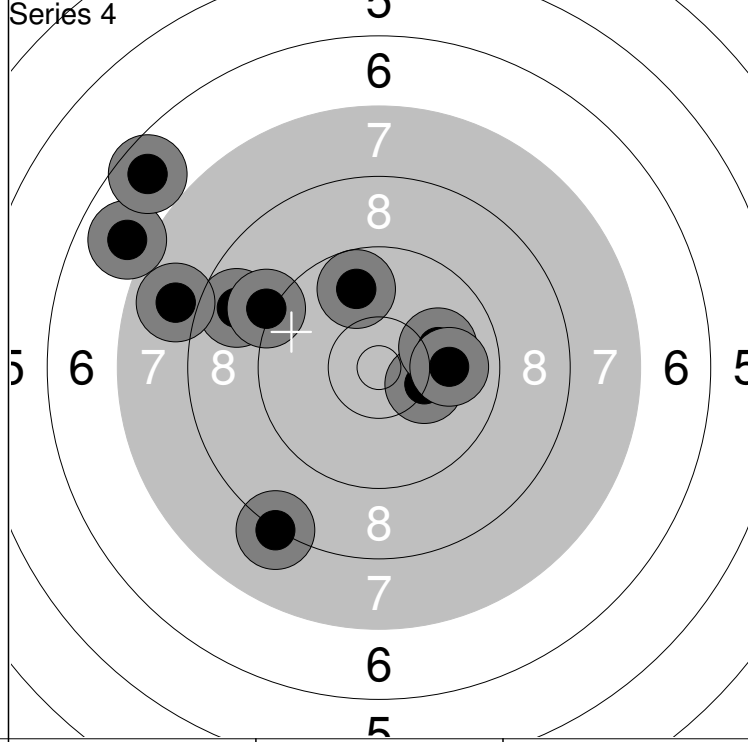
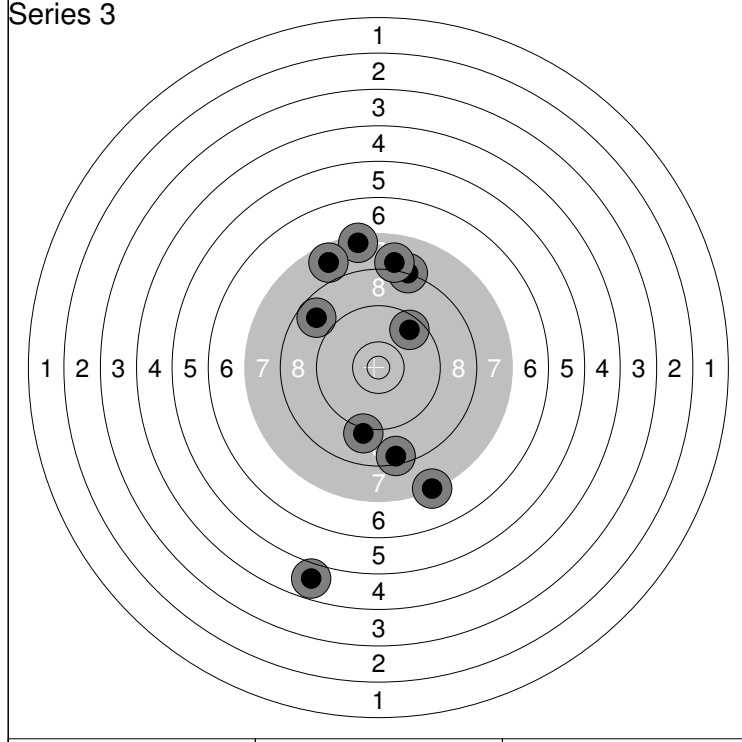

21: 4.8 ↓	26: 8.8 ↗	Series 75.0
22: 8.4 ↓	27: 7.4 ↑	
23: 7.3 ↓	28: 9.6 ↗	Total 232.0
24: 9.1 ↓	29: 7.7 ↗	
25: 8.2 ↑	30: 8.0 ↑	

31: 8.7 ↖	36: 10.3 →	Series 82.0
32: 8.2 ↖	37: 10.1 →	
33: 6.9 ↖	38: 6.7 ↗	Total 314.0
34: 9.1 ↖	39: 9.9 →	
35: 7.9 ↖	40: 9.8 ↑	

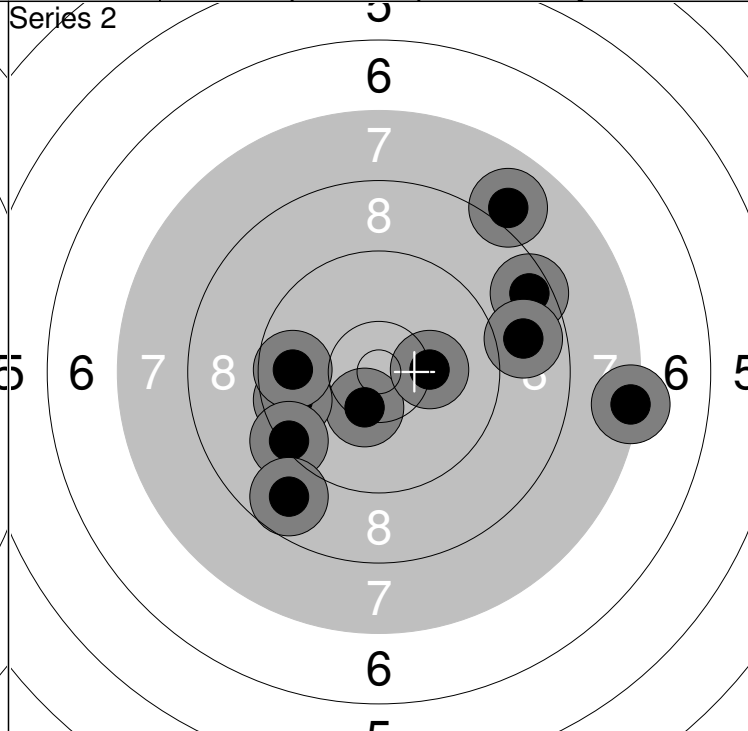
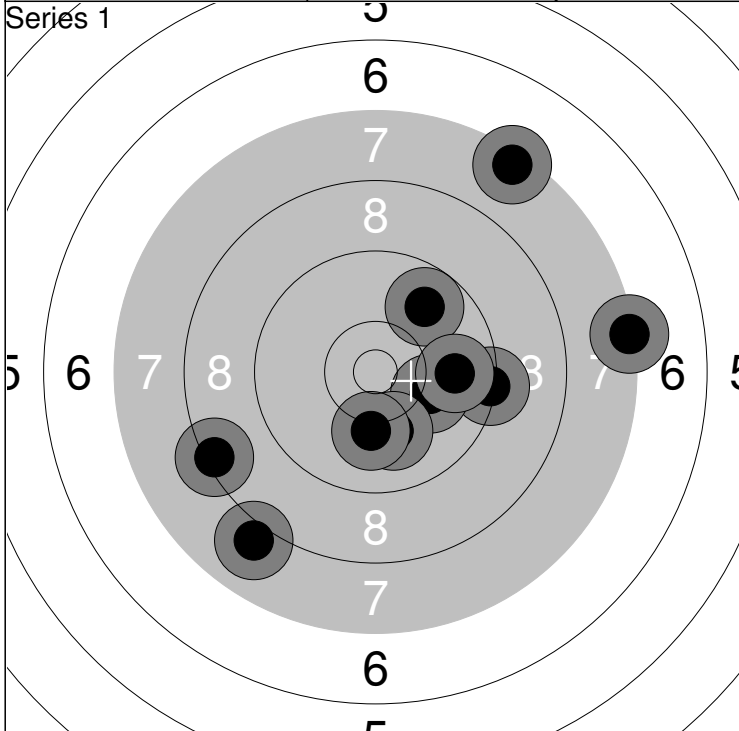

1: 9.3 →	6: 8.0 ↙	Series	87.0
2: 10.1 →	7: 8.4 ↙		
3: 9.8 ↗	8: 7.4 ↗	Total	87.0
4: 9.8 →	9: 10.1 ↘		
5: 7.3 →	10: 10.1 ↘		

11: 8.5 ↗	16: 9.7 ←	Series	86.0
12: 8.0 ↗	17: 9.3 ↙		
13: 10.4x ↘	18: 8.8 →	Total	173.0
14: 10.2 →	19: 8.8 ↘		
15: 9.7 ←	20: 7.3 →		

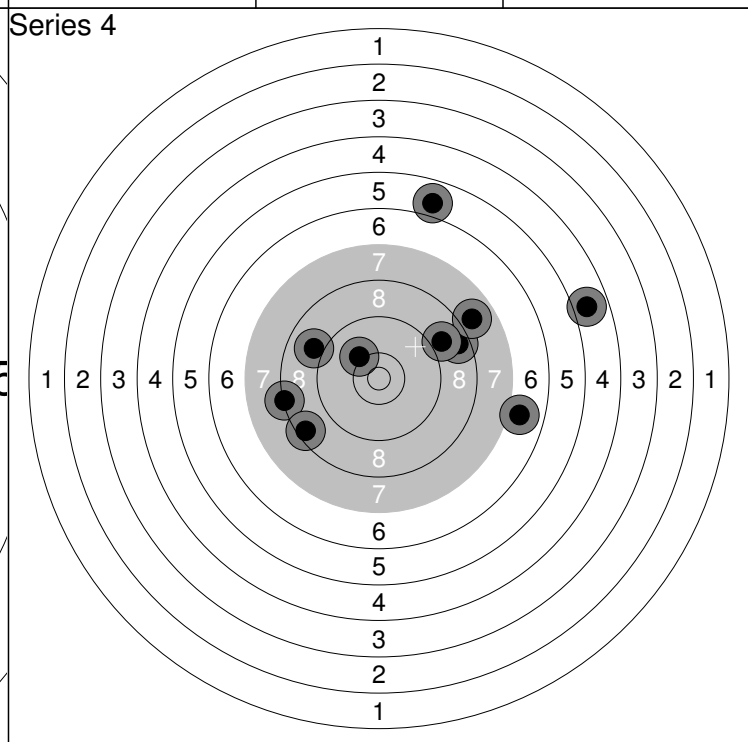
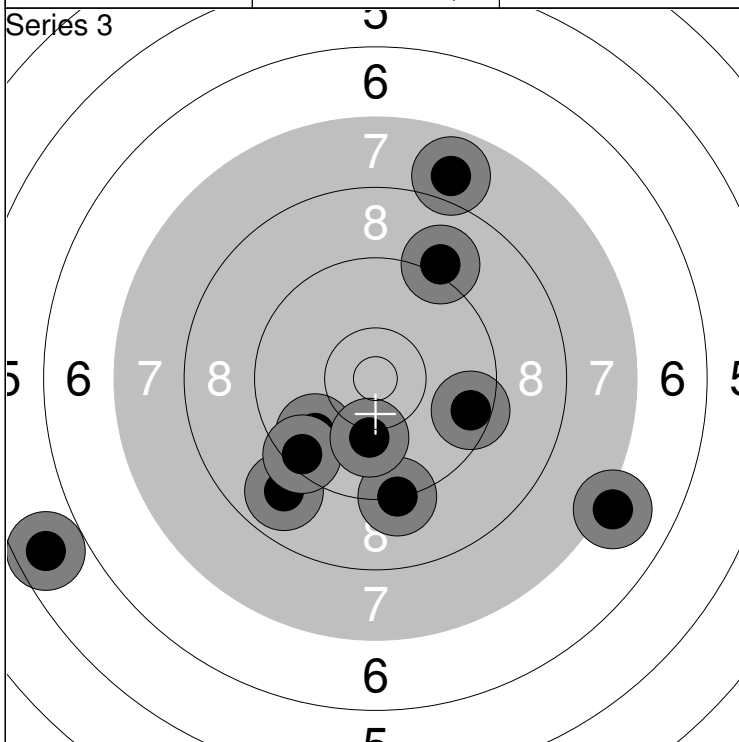

21: 9.1 ↗	26: 7.1 →	Series	82.0
22: 7.9 ↗	27: 5.7 ↙		
23: 9.8 ↙	28: 9.5 ↙	Total	255.0
24: 8.9 ↙	29: 10.1 ↘		
25: 9.2 ↘	30: 9.5 →		

31: 8.5 ↗	36: 5.9 ↗	Series	73.0
32: 10.1 ↗	37: 9.0 ↙		
33: 7.9 ↗	38: 4.8 →	Total	328.0
34: 6.9 →	39: 8.9 ↗		
35: 8.3 ←	40: 8.4 ↙		

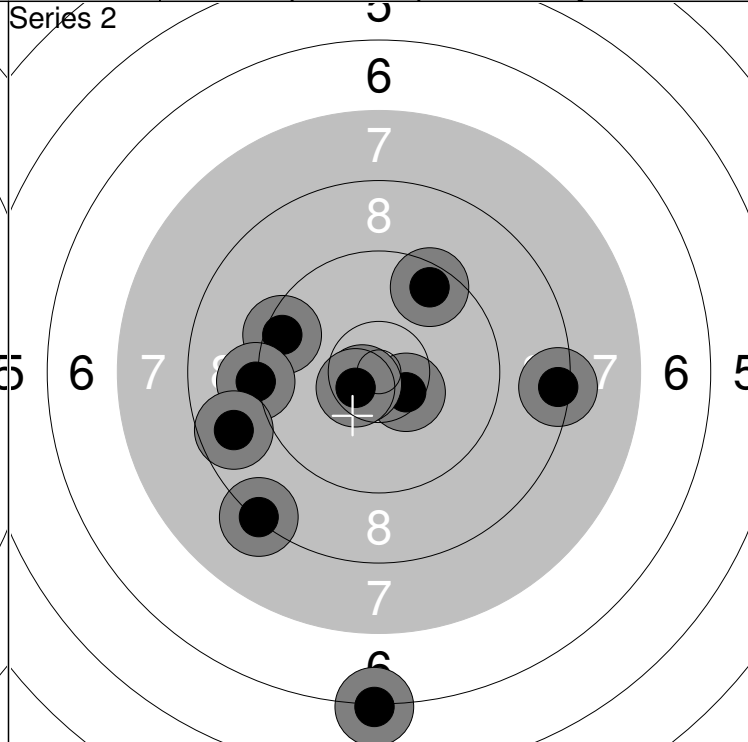
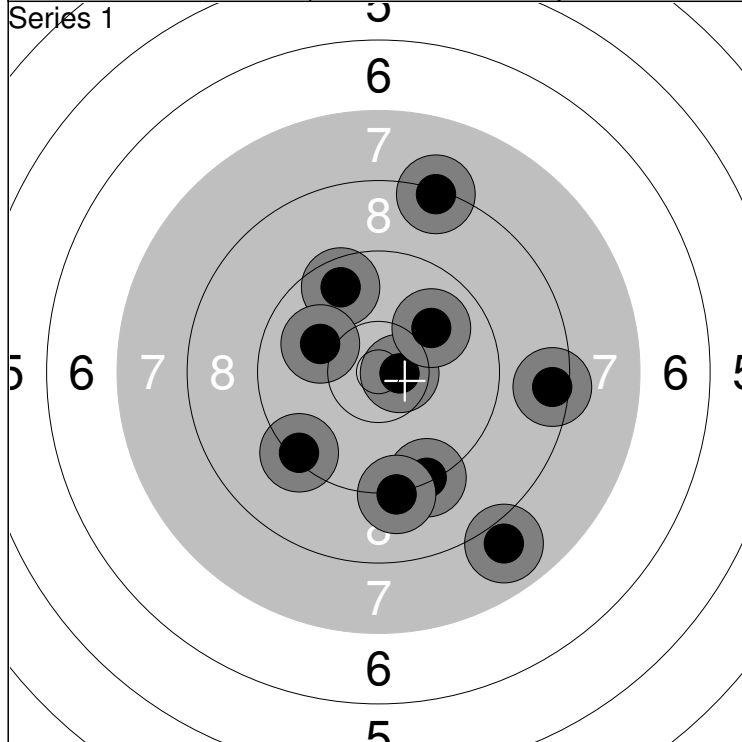

1: 8.3 ↑	6: 9.6 ↑	Series	89.0
2: 8.5 →	7: 10.0 ↖		
3: 10.7x →	8: 9.2 ↓	Total	89.0
4: 7.9 ↓	9: 10.0 ↗		
5: 9.3 ↓	10: 9.3 ↙		

11: 9.5 ↗	16: 8.4 →	Series	87.0
12: 6.2 ↓	17: 10.6x ↖		
13: 10.5x ↘	18: 9.5 ↖	Total	176.0
14: 8.3 ↙	19: 9.2 ←		
15: 10.6x ↙	20: 8.7 ←		

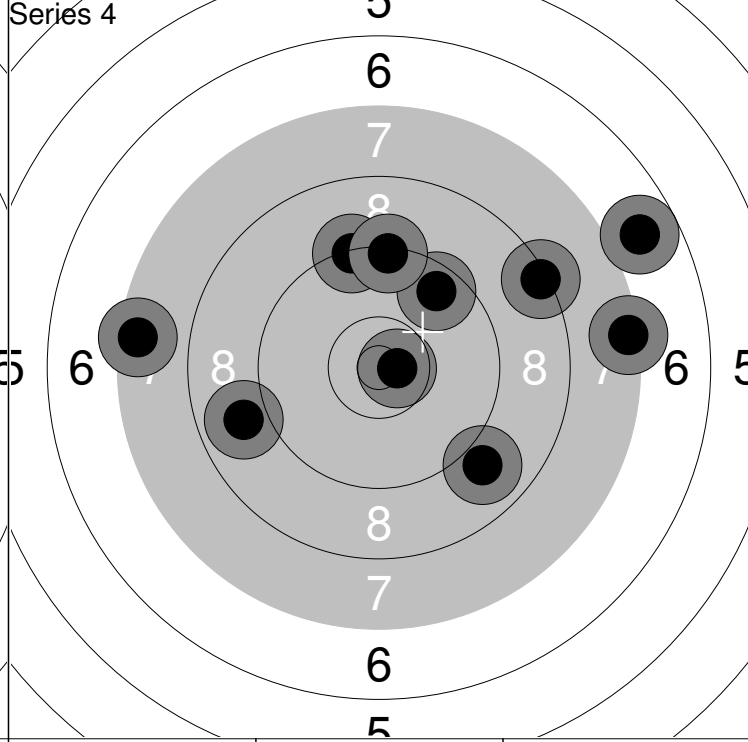
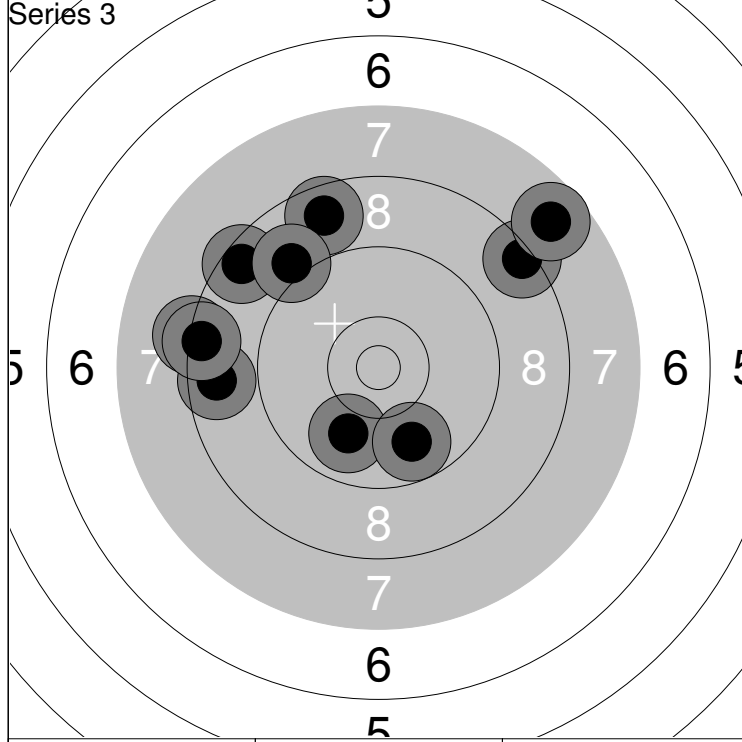

21: 8.3 ←	26: 8.4 ←	Series	82.0
22: 8.7 ↑	27: 7.7 ↗		
23: 8.4 ↗	28: 8.5 ↖	Total	258.0
24: 8.6 ←	29: 9.0 ↗		
25: 9.9 ↓	30: 9.8 ↓		

31: 6.8 ↗	36: 9.6 ↗	Series	81.0
32: 9.3 ↑	37: 8.9 ←		
33: 8.9 ↘	38: 10.7x →	Total	339.0
34: 7.4 →	39: 9.3 ↑		
35: 7.5 ←	40: 8.3 ↗		



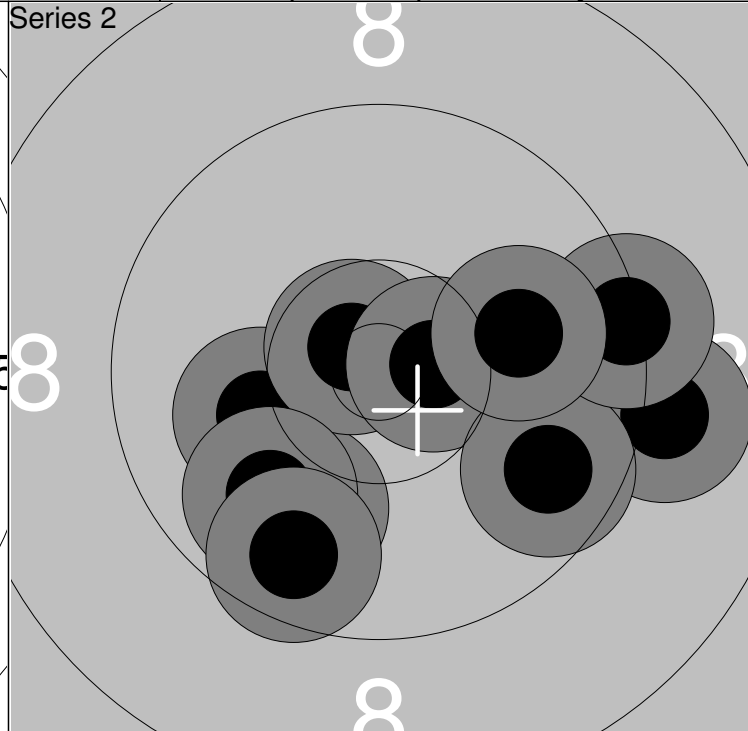
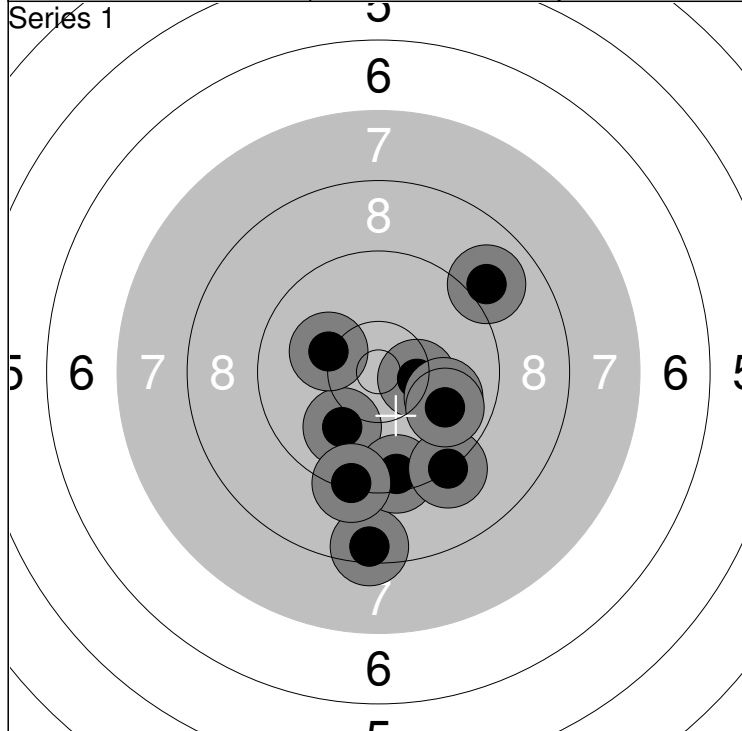

1: 8.5 ↓	6: 9.3 ↓	Series 93.0
2: 10.4x →	7: 9.3 ↓	
3: 10.0 ↙	8: 9.0 ↗	
4: 9.5 ↓	9: 9.9 ↘	
5: 10.0 ↘	10: 10.2 ←	
Total 93.0		

11: 10.1 ←	16: 10.6x →	Series 94.0
12: 9.9 ↙	17: 9.7 ↘	
13: 10.7x ↖	18: 9.6 ↓	
14: 9.9 ↙	19: 9.3 →	
15: 9.1 →	20: 10.0 →	
Total 187.0		

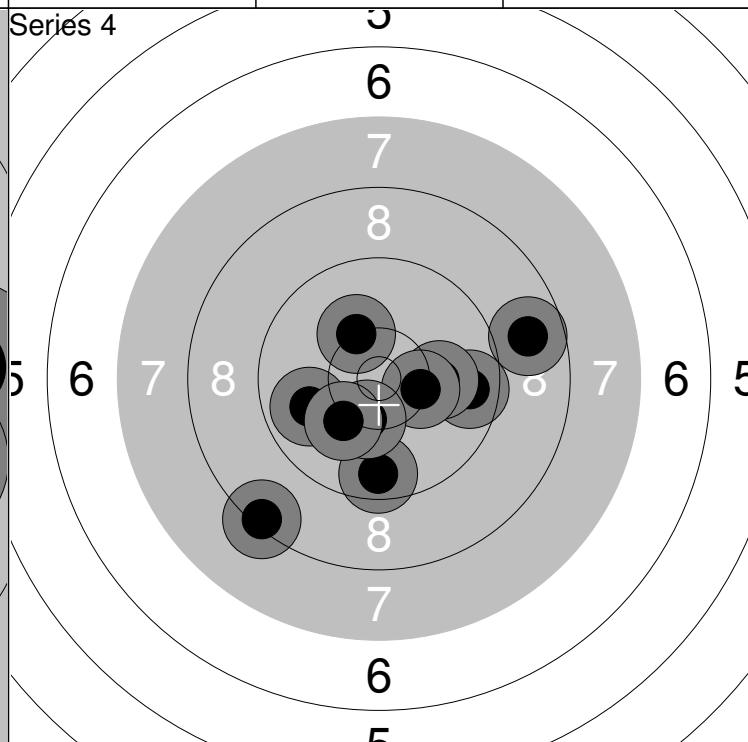
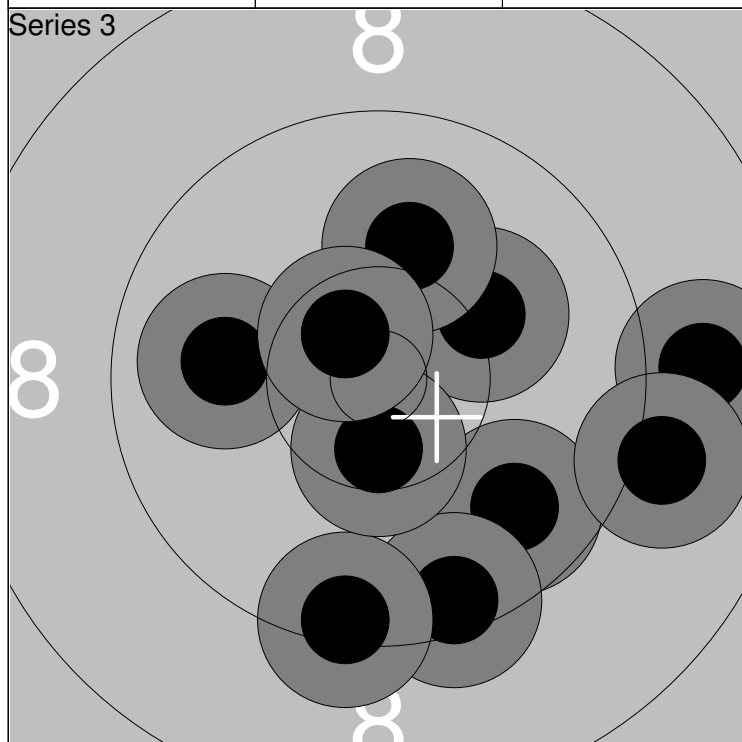

21: 8.9 →	26: 9.4 ↓	Series 94.0
22: 10.2 ↗	27: 9.1 →	
23: 10.0 ←	28: 9.4 ↓	
24: 9.8 ↘	29: 10.5x ↓	
25: 10.1 ↑	30: 10.6x ↗	
Total 281.0		

31: 8.8 →	36: 8.4 ↙	Series 93.0
32: 9.6 ↓	37: 10.4 →	
33: 9.7 →	38: 10.4 ↓	
34: 10.1 →	39: 10.2 ↖	
35: 9.9 ←	40: 10.2 ↙	
Total 374.0		

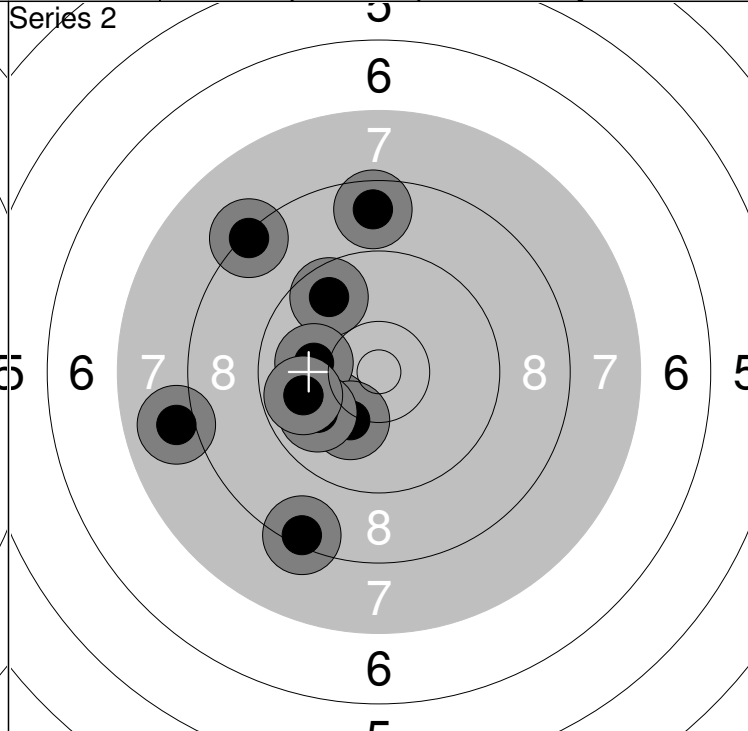
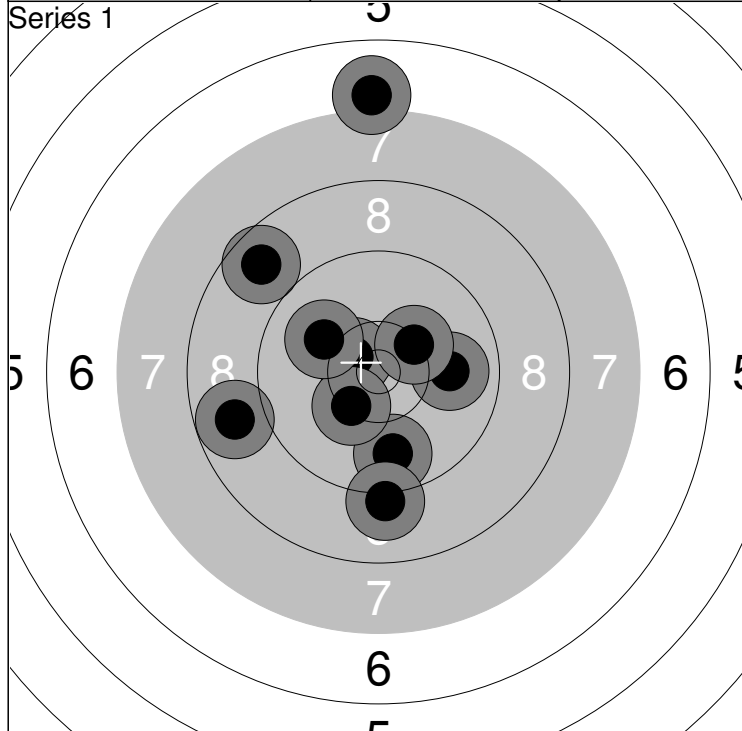

1: 7.0 ↑	6: 10.3 ↗	Series	90.0
2: 9.9 →	7: 10.3 ↘		Total
3: 9.8 ↓	8: 9.1 ↓		
4: 8.8 ←	9: 8.7 ↗		
5: 10.5x ↖	10: 10.1 ↖		

11: 8.4 ↘	16: 10.0 ←	Series	89.0
12: 8.6 ↑	17: 10.1 ↘		Total
13: 9.7 ↗	18: 9.9 ←		
14: 10.1 ↘	19: 8.3 ↖		
15: 8.0 ←	20: 9.8 ←		

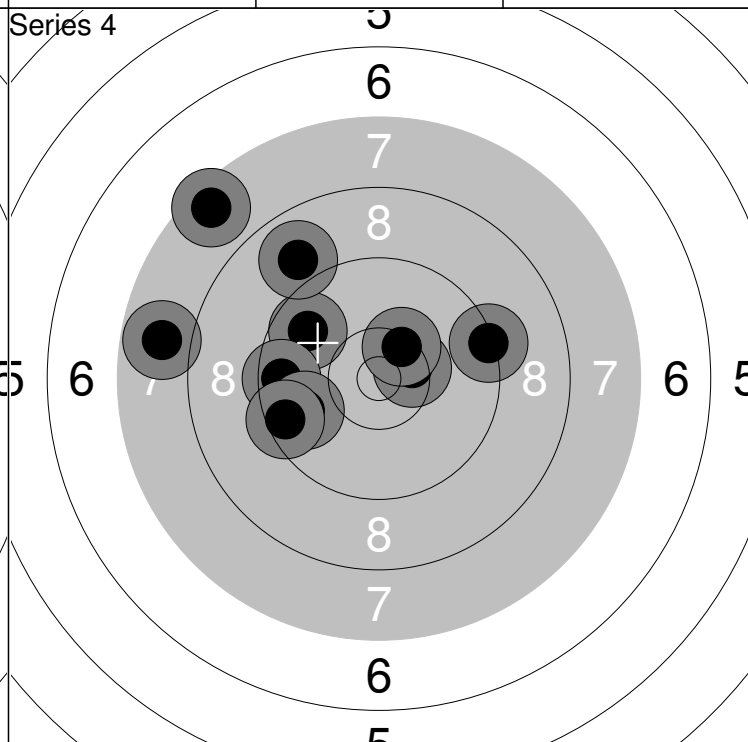
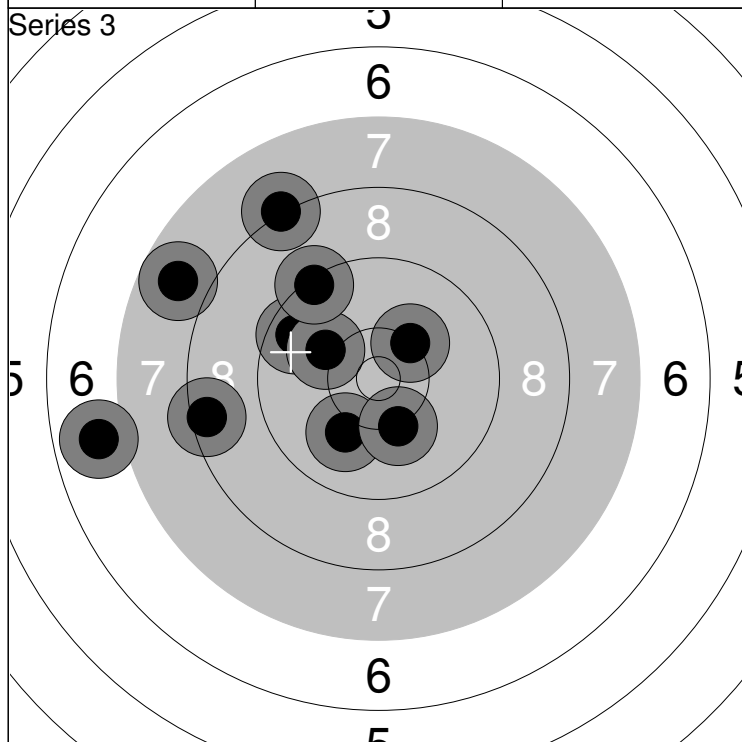

21: 6.9 ←	26: 10.1 ↘	Series	87.0
22: 8.4 ←	27: 10.3 ↗		Total
23: 7.8 ↖	28: 10.2 ↓		
24: 9.6 ↖	29: 8.2 ↗		
25: 10.1 ↖	30: 9.3 ↗		

31: 9.7 ↗	36: 9.3 →	Series	87.0
32: 9.6 ←	37: 7.8 ←		Total
33: 7.5 ↗	38: 9.5 ←		
34: 8.9 ↗	39: 10.5x →		
35: 9.8 ←	40: 10.4x ↗		

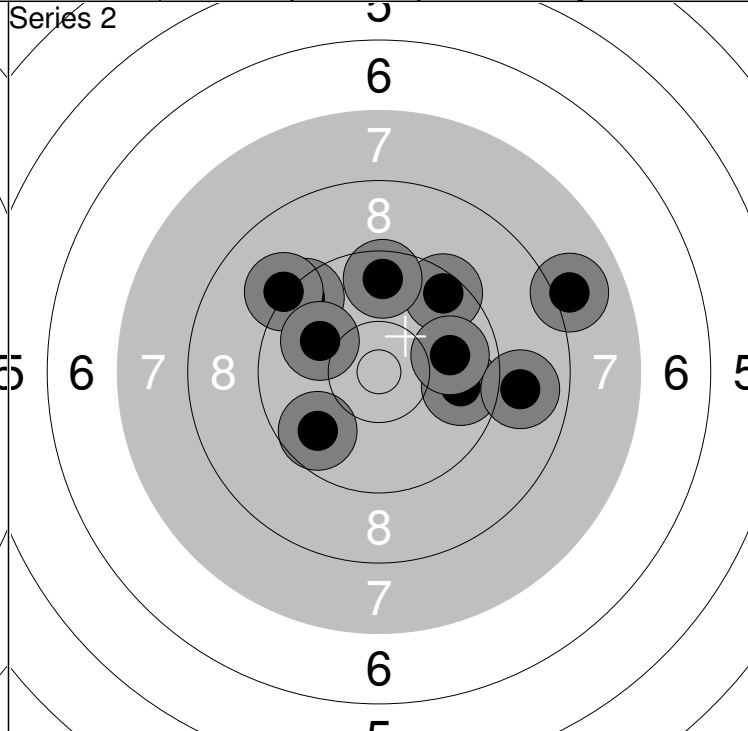
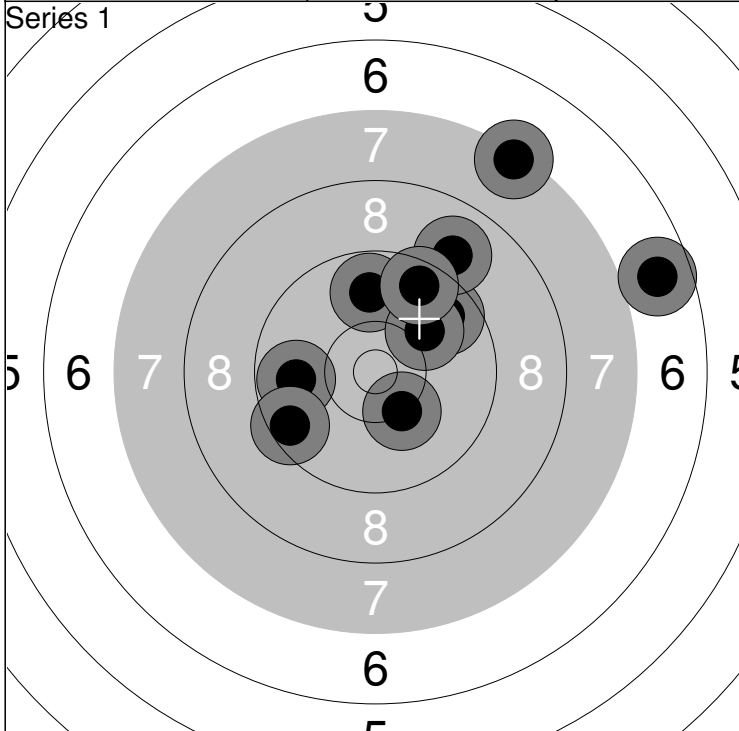

1: 9.7 ↗	6: 9.0 ↗	Series 87.0
2: 9.8 ←	7: 9.8 ↑	
3: 6.7 →	8: 7.3 ↗	Total 87.0
4: 10.3 ↘	9: 10.0 ↗	
5: 9.5 ↙	10: 9.6 ↗	

11: 9.5 ↗	16: 9.9 →	Series 89.0
12: 9.8 →	17: 8.9 →	
13: 9.5 ↗	18: 9.6 ↑	Total 176.0
14: 8.0 →	19: 10.0 ↙	
15: 9.2 ↙	20: 9.7 ↘	

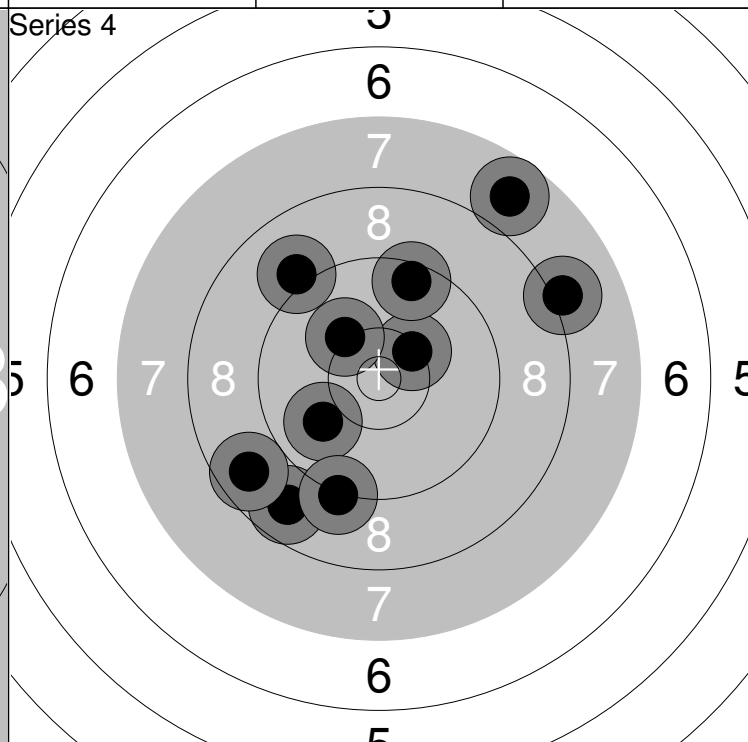
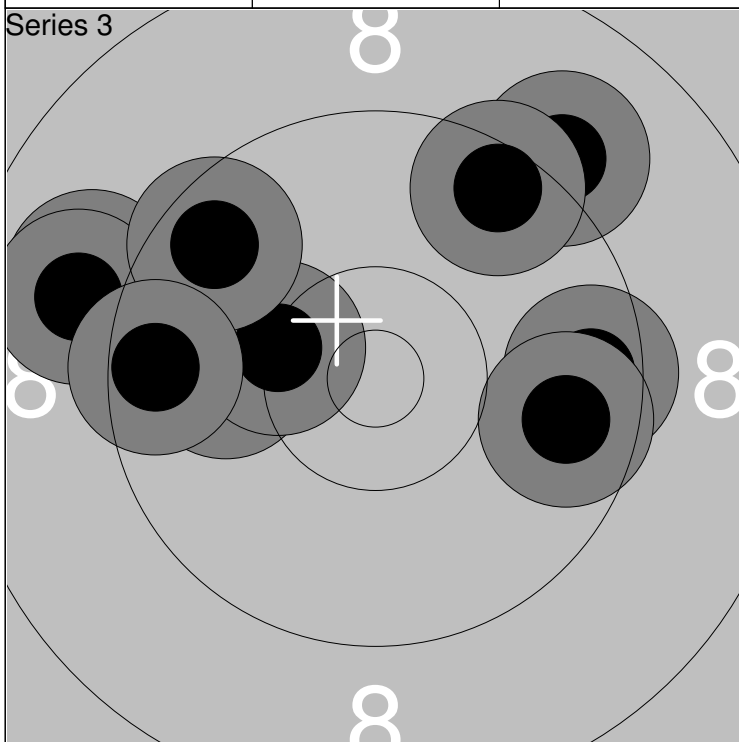

21: 9.0 ←	26: 9.7 →	Series 92.0
22: 10.0 ←	27: 9.1 ↗	
23: 9.6 →	28: 9.5 ↗	Total 268.0
24: 10.3 ←	29: 9.6 ↙	
25: 9.0 ←	30: 9.5 ←	

31: 8.7 ↘	36: 9.5 ↑	Series 87.0
32: 9.1 ↙	37: 7.8 ↗	
33: 8.7 ↙	38: 10.2 ↙	Total 355.0
34: 10.3 ↗	39: 8.1 →	
35: 9.9 ↙	40: 9.2 ↘	

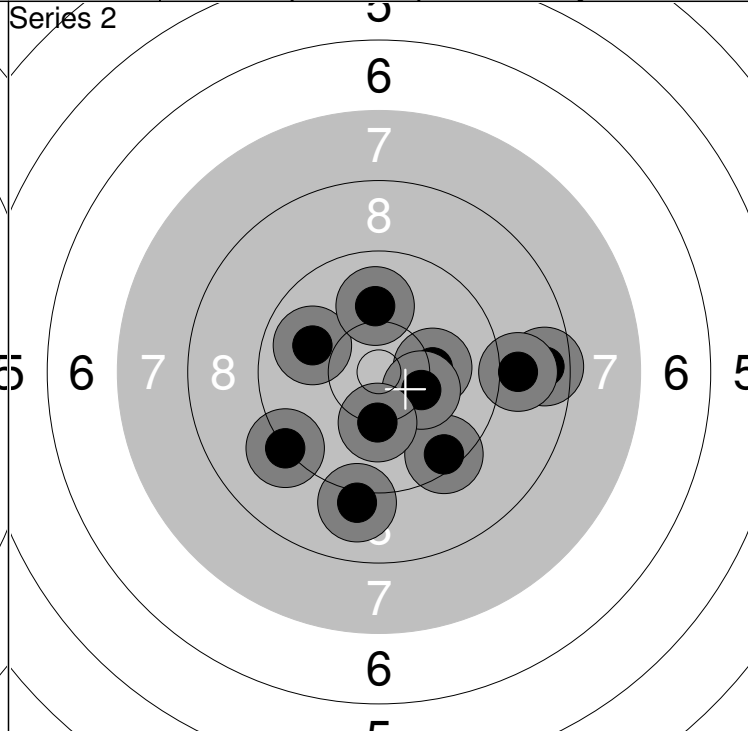
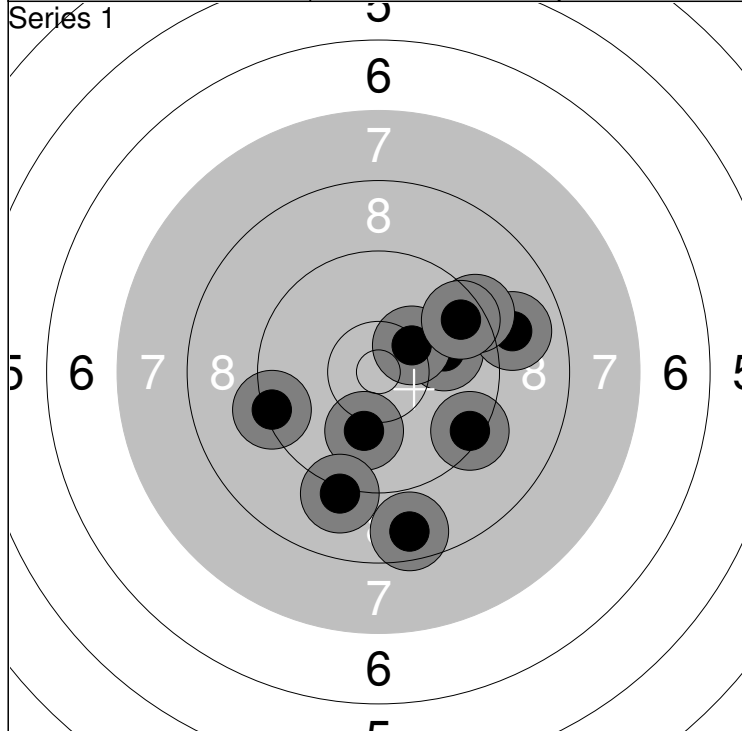

1: 10.0 →	6: 10.3 ↗	Series 92.0
2: 9.0 →	7: 8.6 ↓	
3: 9.4 ↘	8: 10.1 ↓	Total 92.0
4: 9.3 ←	9: 9.6 ↗	
5: 9.3 ↗	10: 9.1 ↓	

11: 9.1 ↓	16: 8.6 →	Series 93.0
12: 9.9 ↖	17: 10.3 →	
13: 10.2 →	18: 9.0 →	Total 185.0
14: 10.0 ↑	19: 9.2 ↙	
15: 9.5 ↘	20: 10.2 ↓	

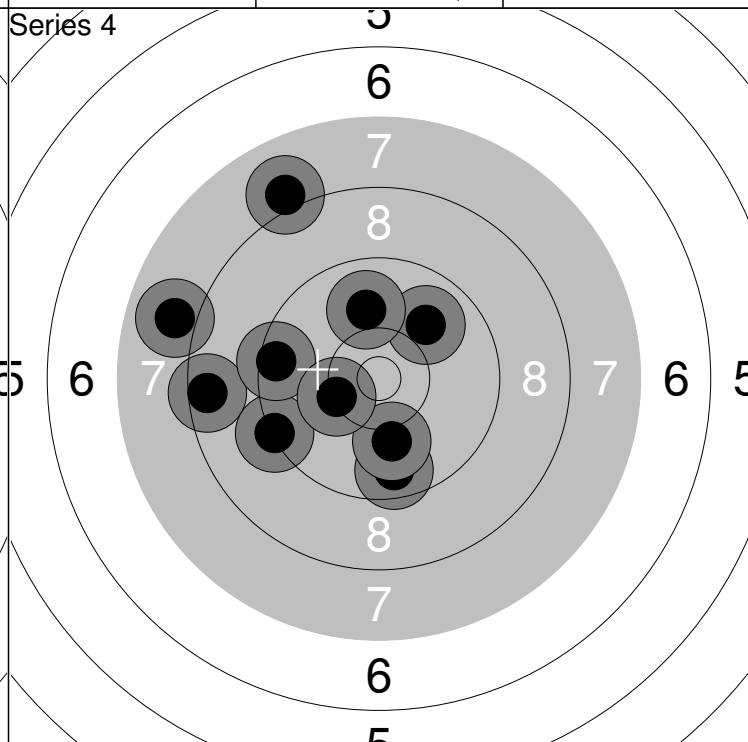
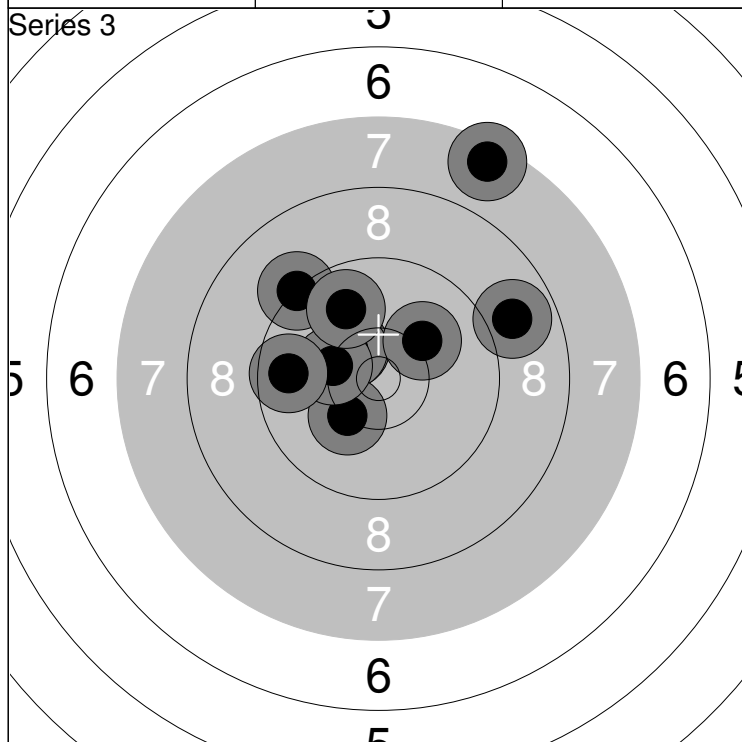

21: 10.4x ↖	26: 10.1 ↗	Series 92.0
22: 7.5 ↑	27: 10.3 ↙	
23: 8.9 →	28: 10.3 ←	Total 277.0
24: 9.2 ↗	29: 9.7 ←	
25: 10.4x ↖	30: 9.9 ↑	

31: 9.9 ↗	36: 9.6 ↓	Series 89.0
32: 10.0 ↑	37: 10.0 ↓	
33: 7.9 ↖	38: 9.5 ←	Total 366.0
34: 8.5 ←	39: 10.3 ←	
35: 9.3 ↖	40: 8.0 ↑	

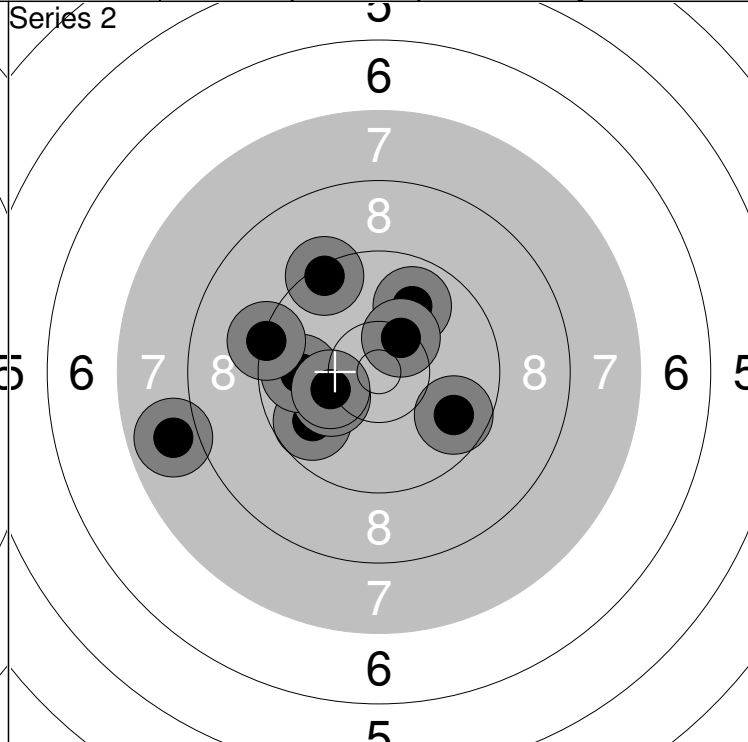
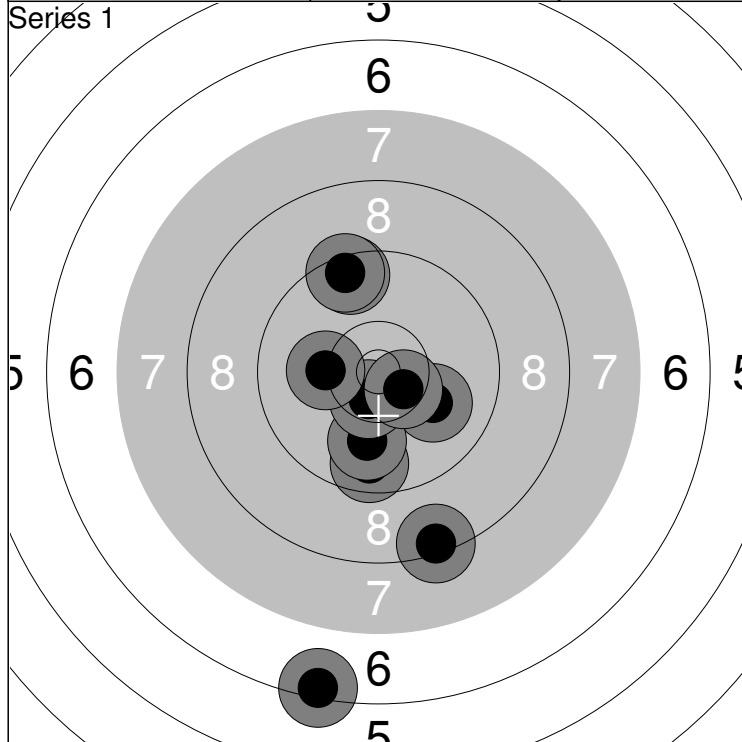

1: 9.5 ↑	6: 6.4 ↓	Series 91.0
2: 8.4 ↓	7: 10.5x ↓	
3: 10.1 →	8: 9.5 ↑	Total 91.0
4: 9.6 ↓	9: 10.2 ←	
5: 10.0 ↓	10: 10.5x →	

11: 9.7 →	16: 10.2 ←	Series 91.0
12: 9.8 ↙	17: 7.9 ←	
13: 10.2 ↙	18: 10.4x ↗	Total 182.0
14: 9.9 ↗	19: 9.4 ↑	
15: 9.8 ←	20: 9.3 ←	

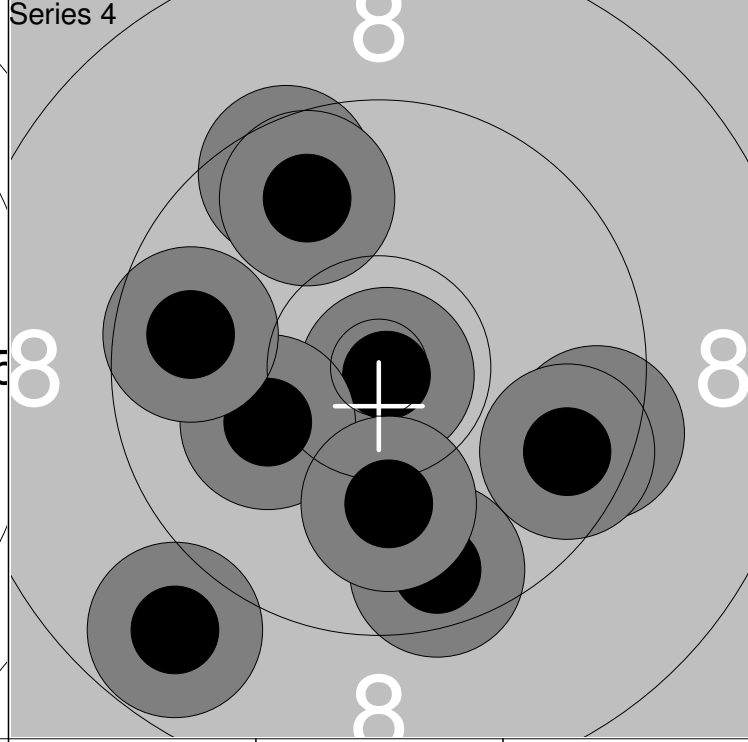
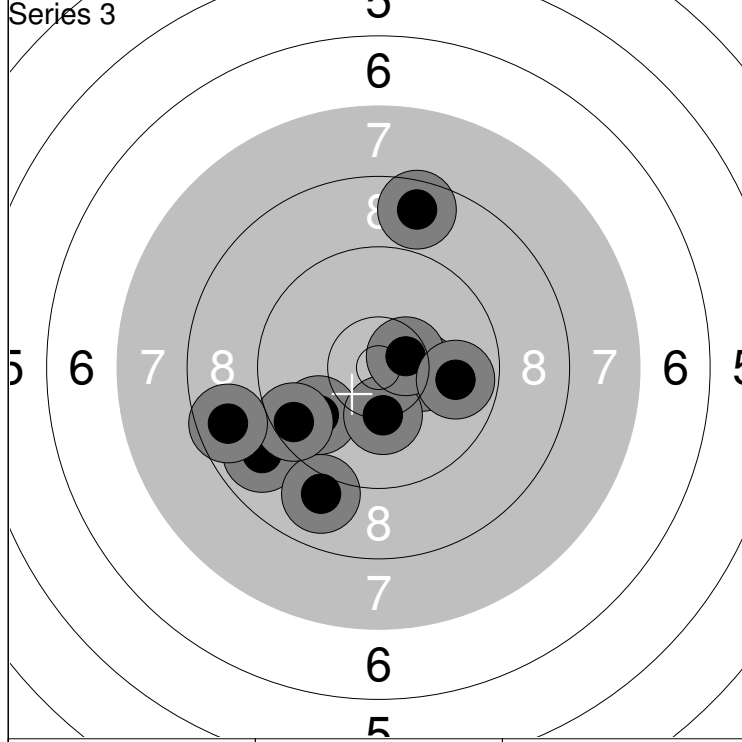

21: 9.9 ↙	26: 8.9 ↙	Series 90.0
22: 10.3 →	27: 9.0 ↓	
23: 10.3 ↓	28: 8.6 ↑	Total 272.0
24: 10.5x ↗	29: 9.5 ↙	
25: 9.8 →	30: 8.7 ←	

31: 10.9x ↘	36: 9.8 ↑	Series 92.0
32: 9.6 ↗	37: 9.5 →	
33: 10.2 ↙	38: 9.7 ←	Total 364.0
34: 9.6 ↓	39: 9.6 →	
35: 10.1 ↓	40: 8.8 ↘	

Relay <b>9</b>	Lane <b>16</b>	<b>Jani Sokura.</b>	
-------------------	-------------------	---------------------	--

Air	KaA	AP Y24
-----	-----	--------

8.-9.2.2014	Aluemestaruuskilpailut	Kankaanpään Ampumaurheilijat
-------------	------------------------	------------------------------

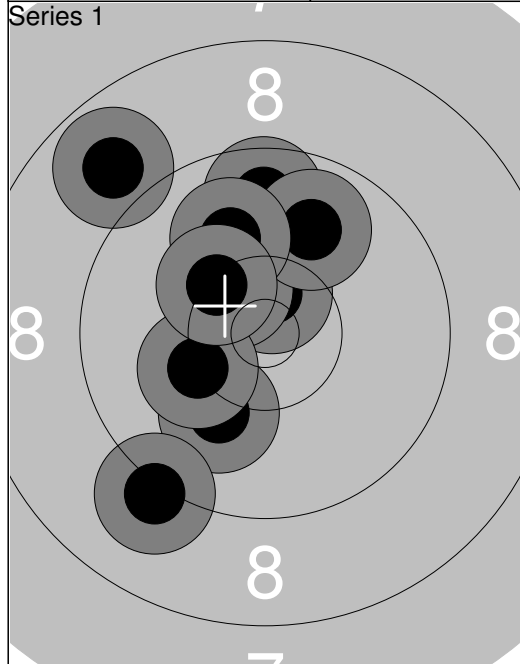

1:	10.6x	↑
2:	9.7	↑
3:	10.4x	↖
4:	9.9	↑
5:	10.0	↑
6:	10.1	↘
7:	9.1	↘
8:	8.9	↖
9:	10.2	↙
10:	10.3	↖
Series	95.0	
Total	95.0	

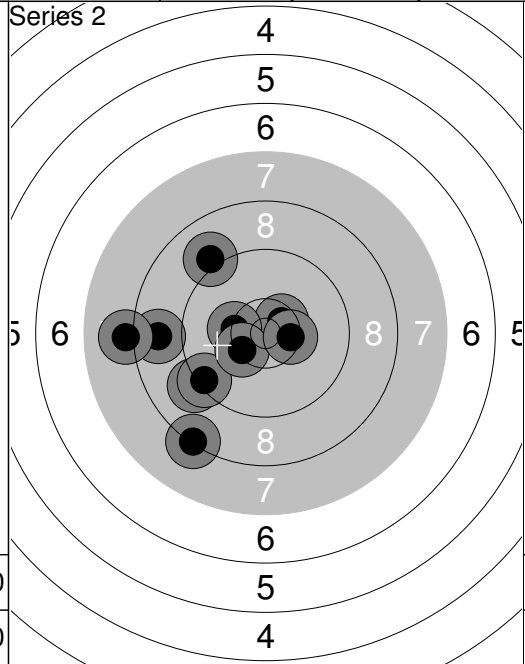

11:	10.5x	↗
12:	8.7	←
13:	10.3	←
14:	9.1	↘
15:	9.4	↘
16:	10.4	↘
17:	9.0	↖
18:	10.4x	→
19:	8.3	↘
20:	8.1	←
Series	91.0	
Total	186.0	

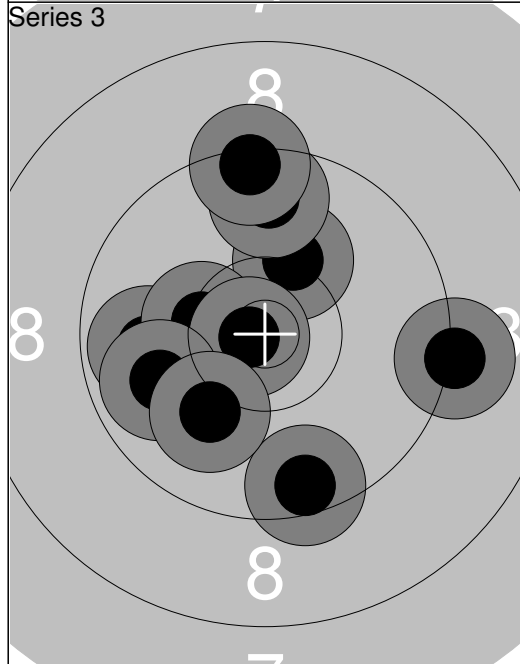

21:	10.2	↑
22:	9.9	←
23:	10.4	←
24:	9.7	↑
25:	9.5	↘
26:	9.4	↑
27:	10.8x	←
28:	9.9	←
29:	9.2	→
30:	10.1	↘
Series	94.0	
Total	280.0	

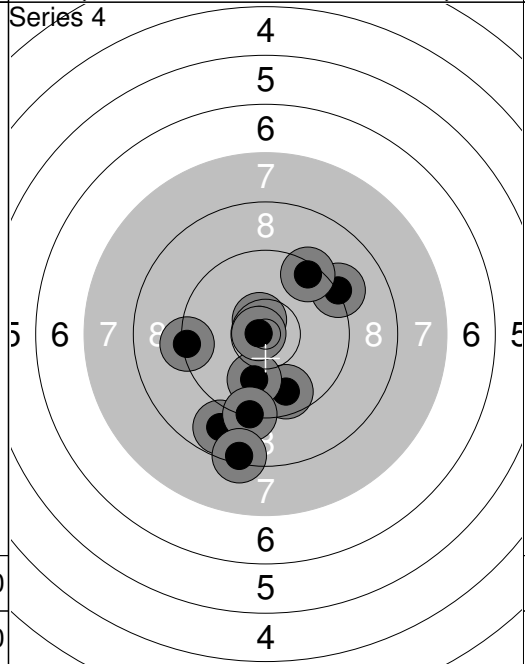

31:	9.3	←
32:	8.8	↘
33:	10.6x	↖
34:	9.7	↘
35:	10.0	↘
36:	9.3	↘
37:	8.4	↘
38:	10.8x	←
39:	9.2	↗
40:	9.4	↖
Series	91.0	
Total	371.0	

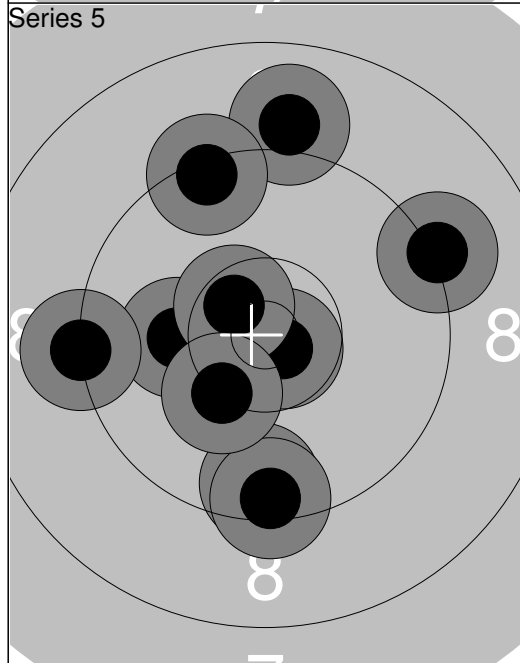

41:	9.6	↘
42:	9.4	↘
43:	10.1	←
44:	10.7x	↘
45:	9.0	↑
46:	9.2	←
47:	10.5x	↖
48:	10.3	↘
49:	9.2	↗
50:	9.4	↑
Series	94.0	
Total	465.0	

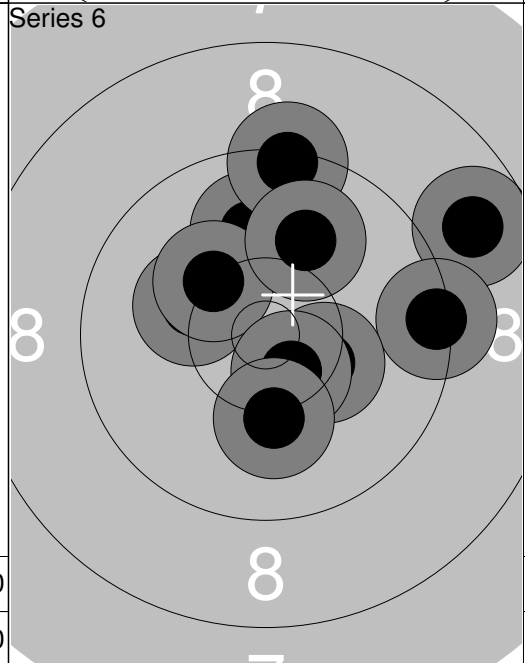

51:	10.2	←
52:	10.0	↑
53:	8.8	↗
54:	9.3	↑
55:	10.2	↖
56:	9.4	→
57:	10.0	↖
58:	10.3	↘
59:	10.5x	↘
60:	10.2	↘
Series	96.0	
Total	561.0	

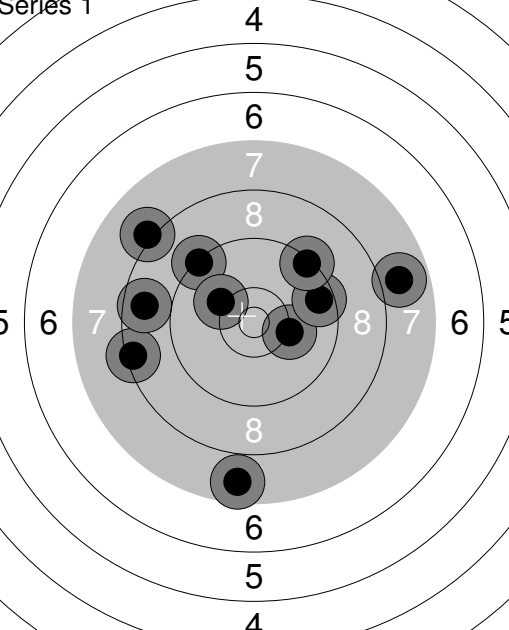
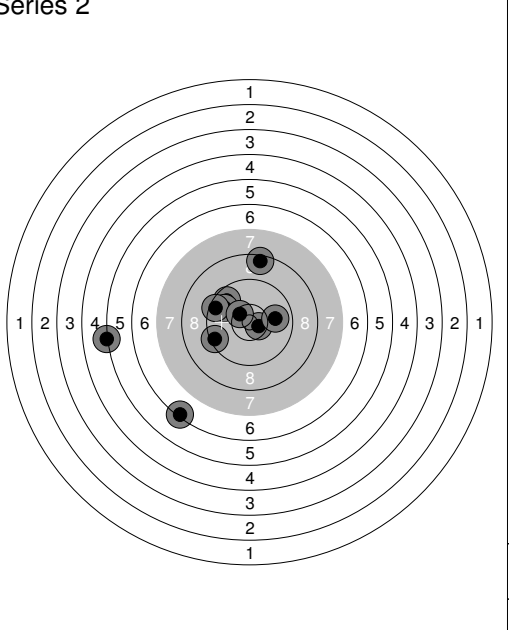
<p>Series 1</p> 	<p>1: 8.4 ←</p> <p>2: 8.7 ←</p> <p>3: 10.2 →</p> <p>4: 9.3 ↗</p> <p>5: 9.5 →</p> <p>6: 7.7 ↓</p> <p>7: 7.8 →</p> <p>8: 8.1 ↗</p> <p>9: 10.2 ↖</p> <p>10: 9.3 ↗</p> <p>Series 85.0</p> <p>Total 85.0</p>	<p>Series 2</p>  <p>11: 9.7 ↗</p> <p>12: 9.8 ↖</p> <p>13: 9.5 ↖</p> <p>14: 9.4 ↖</p> <p>15: 8.5 ↑</p> <p>16: 10.6x →</p> <p>17: 6.3 ↘</p> <p>18: 5.2 ←</p> <p>19: 10.4x ↖</p> <p>20: 9.9 →</p> <p>Series 84.0</p> <p>Total 169.0</p>
--	---	--

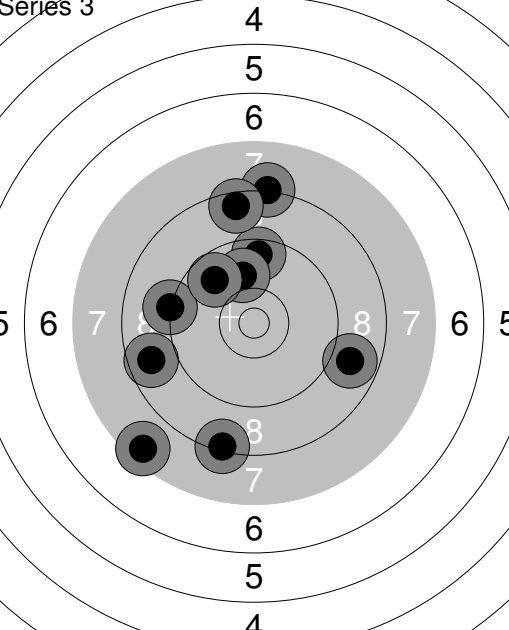
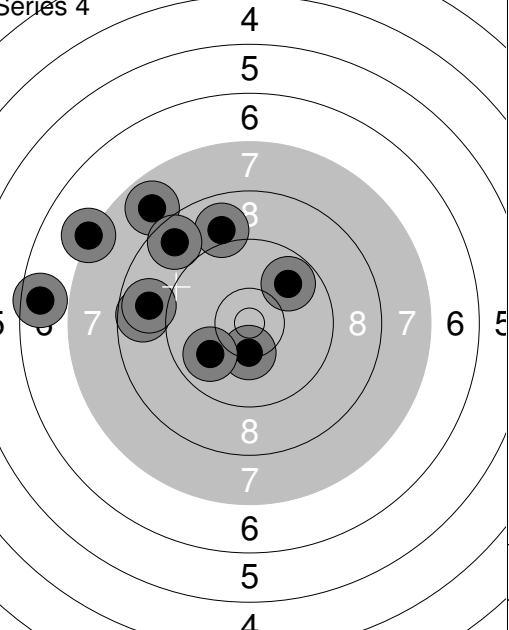
<p>Series 3</p> 	<p>21: 8.7 ←</p> <p>22: 9.5 ↑</p> <p>23: 8.3 ↓</p> <p>24: 8.2 ↑</p> <p>25: 8.5 ↑</p> <p>26: 8.8 →</p> <p>27: 9.9 ↑</p> <p>28: 9.2 ←</p> <p>29: 9.7 ↗</p> <p>30: 7.5 ↘</p> <p>Series 83.0</p> <p>Total 252.0</p>	<p>Series 4</p>  <p>31: 8.8 ←</p> <p>32: 10.3 ↓</p> <p>33: 6.6 ←</p> <p>34: 9.8 ↗</p> <p>35: 9.0 ↑</p> <p>36: 7.9 ↖</p> <p>37: 9.9 ↖</p> <p>38: 8.7 ↖</p> <p>39: 7.2 ↖</p> <p>40: 8.9 ←</p> <p>Series 81.0</p> <p>Total 333.0</p>
---	---	--

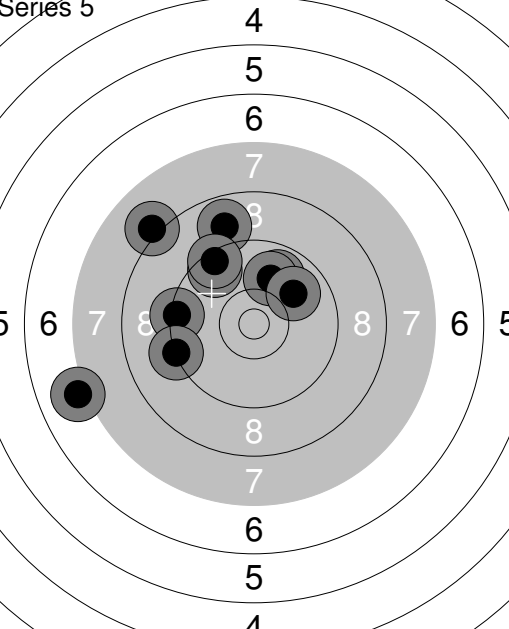
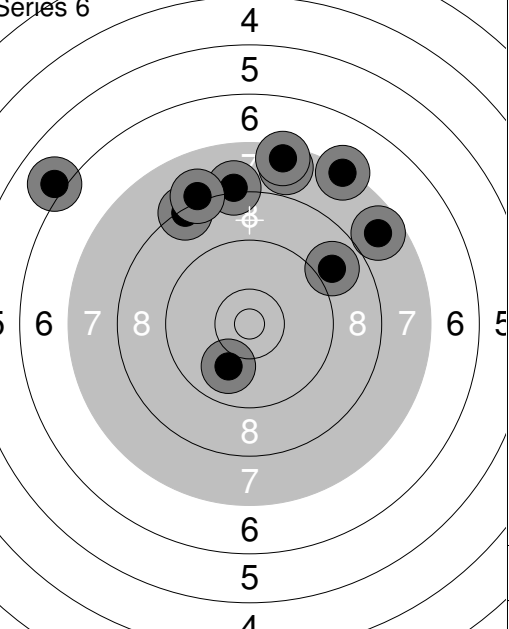
<p>Series 5</p> 	<p>41: 9.6 ↖</p> <p>42: 9.9 ↗</p> <p>43: 9.4 ←</p> <p>44: 8.1 ↗</p> <p>45: 10.0 ↑</p> <p>46: 9.2 ←</p> <p>47: 9.9 ↗</p> <p>48: 8.9 ↑</p> <p>49: 7.1 ←</p> <p>50: 9.4 ↖</p> <p>Series 87.0</p> <p>Total 420.0</p>	<p>Series 6</p>  <p>51: 8.3 ↖</p> <p>52: 8.9 ↗</p> <p>53: 7.7 ↑</p> <p>54: 8.1 ↑</p> <p>55: 10.0 ↓</p> <p>56: 7.7 ↗</p> <p>57: 7.5 ↑</p> <p>58: 8.1 ↖</p> <p>59: 6.0 ↖</p> <p>60: 7.3 ↗</p> <p>Series 76.0</p> <p>Total 496.0</p>
--	--	---

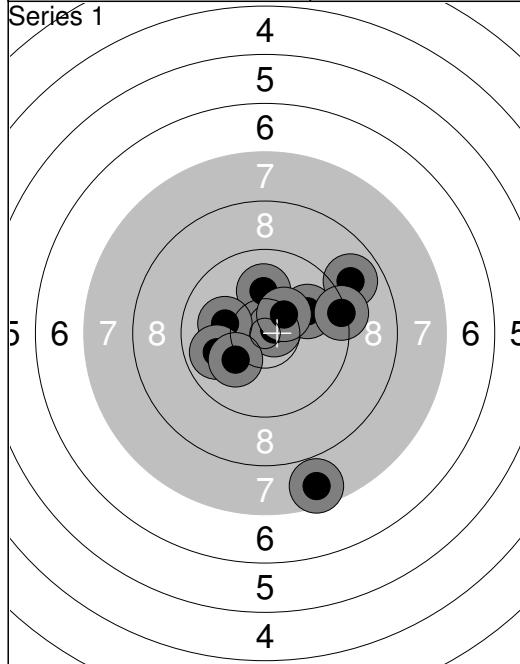

1:	10.1	↑
2:	10.7x	→
3:	10.1	←
4:	9.9	←
5:	8.9	→
6:	10.0	→
7:	10.4x	↗
8:	10.1	←
9:	7.6	↓
10:	9.3	→
Series	93.0	
Total	93.0	

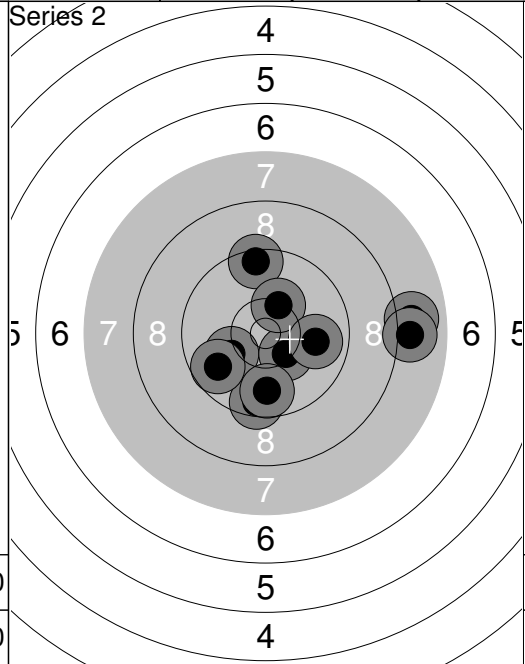

11:	9.5	↑
12:	10.1	↙
13:	8.0	→
14:	9.5	↓
15:	10.4x	↘
16:	8.0	→
17:	9.8	↙
18:	10.3	↗
19:	9.8	↓
20:	9.9	→
Series	91.0	
Total	184.0	

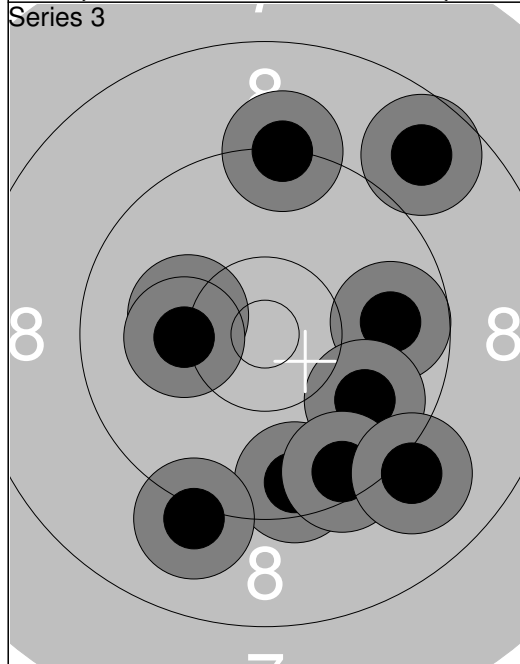

21:	9.5	↓
22:	9.8	→
23:	9.2	↑
24:	10.2	←
25:	9.8	↘
26:	8.7	↗
27:	9.5	↓
28:	9.1	↓
29:	10.2	←
30:	9.1	↓
Series	91.0	
Total	275.0	

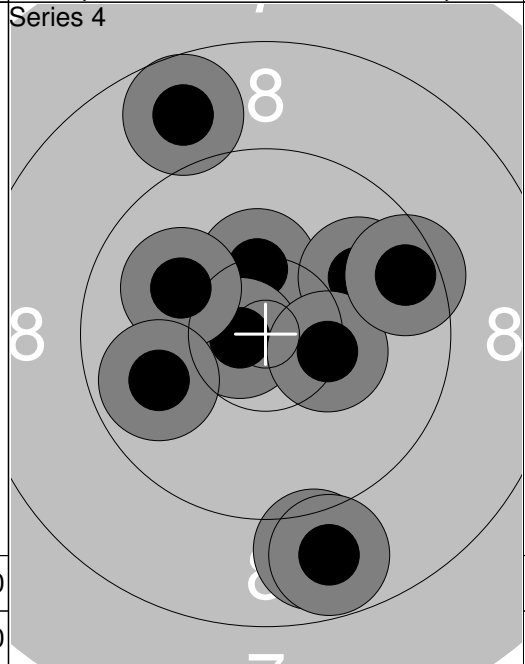

31:	10.3	↑
32:	10.7x	↙
33:	8.8	↑
34:	8.9	↓
35:	10.1	↙
36:	9.9	↗
37:	10.3	→
38:	8.8	↓
39:	9.9	↙
40:	9.5	→
Series	91.0	
Total	366.0	

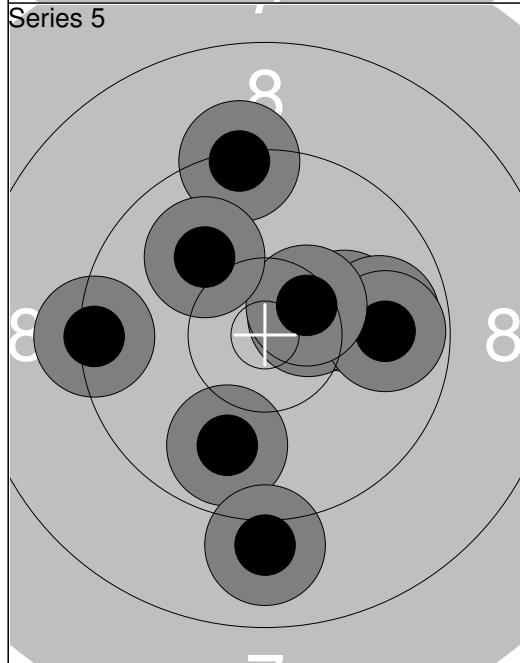

41:	10.2	→
42:	10.5x	→
43:	9.9	↓
44:	9.0	↓
45:	9.9	→
46:	9.8	→
47:	9.3	↑
48:	9.4	←
49:	10.5x	↗
50:	10.0	↖
Series	94.0	
Total	460.0	

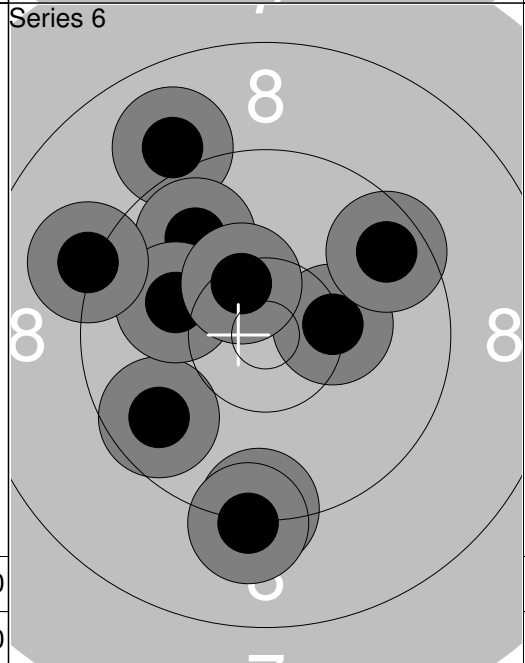

51:	9.0	↖
52:	9.8	↖
53:	9.3	↓
54:	9.7	↙
55:	9.2	↓
56:	10.3	→
57:	10.1	↙
58:	9.6	↗
59:	9.2	↙
60:	10.4x	↖
Series	93.0	
Total	553.0	



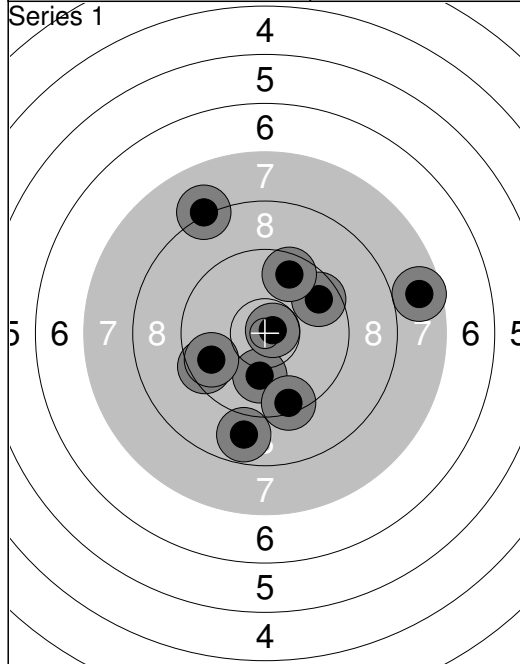

1:	7.7	→
2:	10.1	↓
3:	9.5	↙
4:	9.4	↓
5:	9.7	↙
6:	10.8x	→
7:	8.8	↓
8:	9.7	↗
9:	9.6	↑
10:	8.2	↖
Series		88.0
Total		88.0

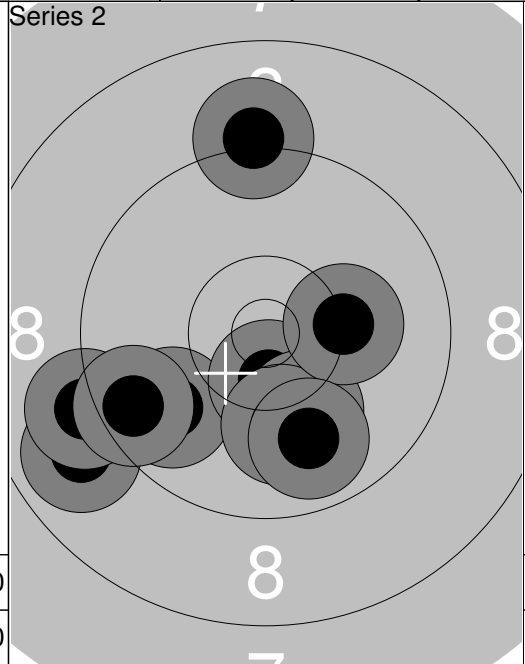

11:	9.8	↙
12:	8.9	↙
13:	9.1	↑
14:	10.5x	↓
15:	10.2	↓
16:	9.1	↙
17:	10.1	↓
18:	9.6	↙
19:	10.2	→
20:	9.9	↓
Series		93.0
Total		181.0

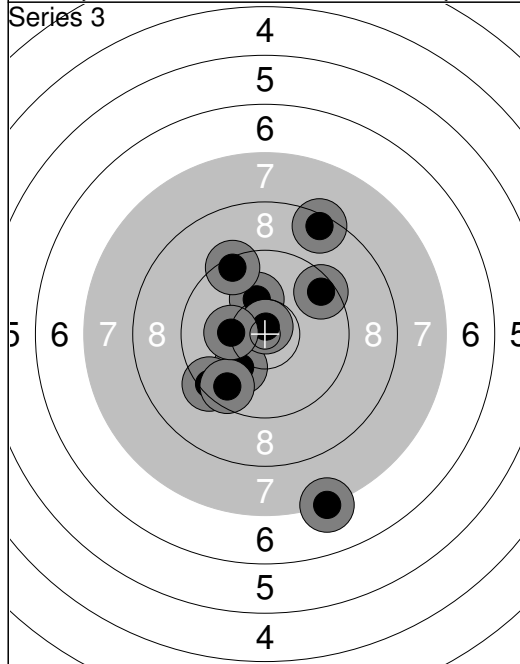

21:	10.2	↑
22:	10.1	↙
23:	9.4	↙
24:	9.6	↙
25:	8.5	↗
26:	9.5	↗
27:	9.4	↖
28:	10.8x	↑
29:	10.3	←
30:	7.2	↓
Series		91.0
Total		272.0

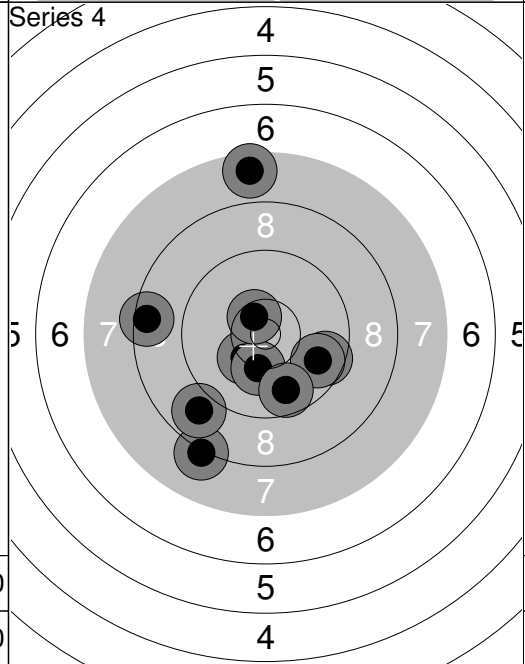

31:	8.2	↙
32:	10.3	↙
33:	8.9	↙
34:	7.6	↑
35:	9.6	→
36:	10.2	↓
37:	9.8	→
38:	10.5x	↖
39:	8.5	←
40:	9.7	↓
Series		88.0
Total		360.0

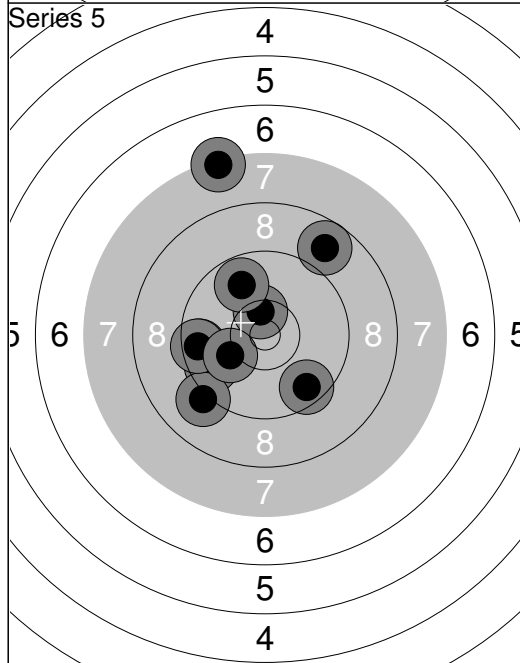

41:	10.5x	↑
42:	9.6	←
43:	9.7	↙
44:	8.8	↗
45:	9.1	↙
46:	9.8	↖
47:	9.5	←
48:	7.3	↑
49:	9.6	↓
50:	10.1	↙
Series		89.0
Total		449.0

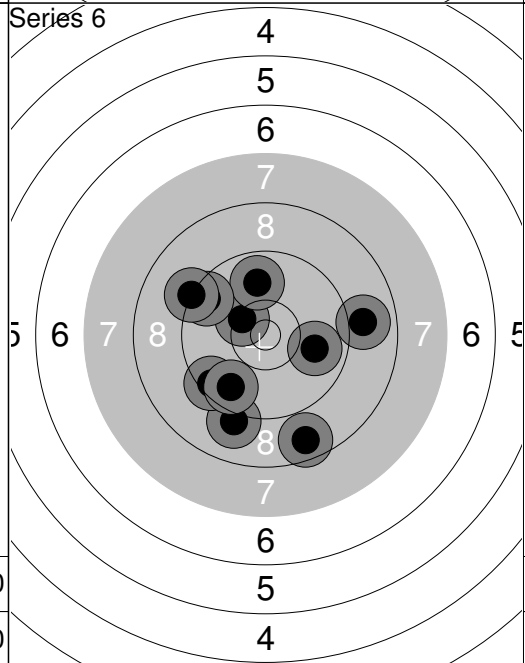

51:	9.1	↙
52:	10.4x	↖
53:	9.5	↙
54:	9.9	↑
55:	9.9	→
56:	9.5	↖
57:	9.2	↖
58:	9.7	↙
59:	8.6	↓
60:	8.9	→
Series		89.0
Total		538.0

<p><b>Series 1</b></p>	<p>1: 9.1 ↙ 2: 9.0 ↘ 3: 9.2 ↙ 4: 9.7 ↗ 5: 8.7 ↑ 6: 9.5 ↙ 7: 8.5 ↑ 8: 9.5 ↘ 9: 9.3 ← 10: 10.4x →</p> <p>Series 89.0 Total 89.0</p>	<p><b>Series 2</b></p>	<p>11: 9.9 ↗ 12: 10.0 ↗ 13: 8.9 ↙ 14: 7.5 ← 15: 9.8 ↗ 16: 9.6 ↖ 17: 10.6x ↑ 18: 9.8 ← 19: 9.3 ← 20: 9.9 ↓</p> <p>Series 89.0 Total 178.0</p>
------------------------	---	------------------------	--

<p><b>Series 3</b></p>	<p>21: 9.5 ↑ 22: 10.4x ↓ 23: 7.9 ↗ 24: 9.6 ↘ 25: 9.9 ↘ 26: 9.7 ↗ 27: 10.6x → 28: 10.5x ↓ 29: 8.3 ↗ 30: 9.9 ↑</p> <p>Series 90.0 Total 268.0</p>	<p><b>Series 4</b></p>	<p>31: 9.1 ↖ 32: 9.1 ↑ 33: 9.9 ↓ 34: 10.7x ↓ 35: 8.8 ← 36: 10.0 ↖ 37: 9.2 ↓ 38: 9.9 → 39: 10.1 ← 40: 8.2 ↗</p> <p>Series 91.0 Total 359.0</p>
------------------------	---	------------------------	---

<p><b>Series 5</b></p>	<p>41: 10.4x ↓ 42: 8.7 ↗ 43: 10.5x ↖ 44: 8.4 ↗ 45: 10.1 ↘ 46: 9.4 ↗ 47: 8.5 ↗ 48: 10.3 ↗ 49: 8.4 ↗ 50: 9.2 ↓</p> <p>Series 90.0 Total 449.0</p>	<p><b>Series 6</b></p>	<p>51: 9.0 ↖ 52: 9.1 ↖ 53: 8.1 ↗ 54: 10.8x ← 55: 9.3 ↑ 56: 6.8 ↘ 57: 9.1 ↗ 58: 9.2 → 59: 10.5x ↗ 60: 8.8 ←</p> <p>Series 87.0 Total 536.0</p>
------------------------	---	------------------------	---