

1: 9.8 ↓	6: 6.3 →	<b>Series</b> 72.0
2: 5.4 ↓	7: 9.4 ↙	
3: 8.5 ←	8: 8.4 →	<b>Total</b> 72.0
4: 7.0 →	9: 9.0 ←	
5: 3.2 ↓	10: 8.5 →	

11: 4.7 ↗	16: 8.8 →	<b>Series</b> 73.0
12: 8.1 ↓	17: 5.3 ↓	
13: 7.3 ←	18: 9.1 ↗	<b>Total</b> 145.0
14: 8.9 ↗	19: 5.0 ↓	
15: 9.9 ↗	20: 10.0 →	

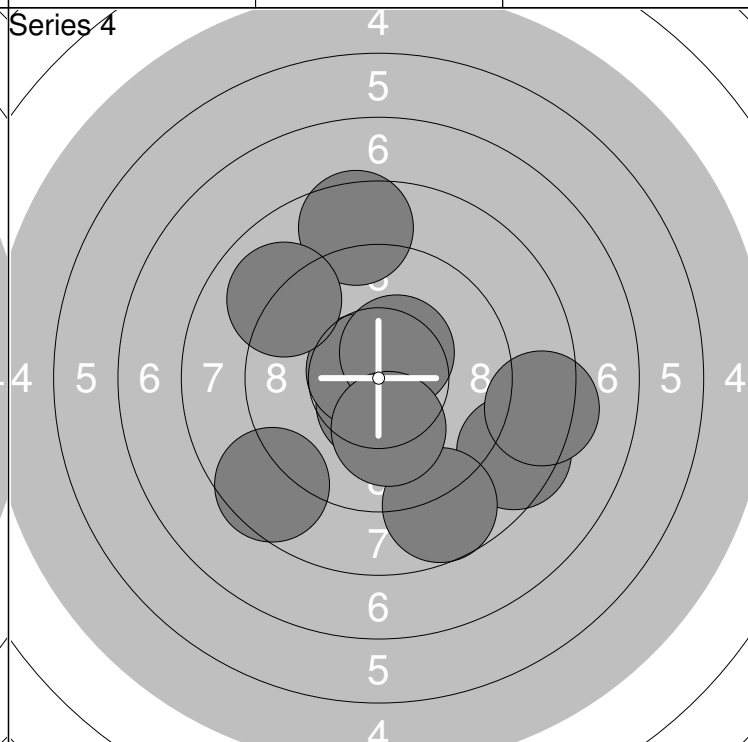
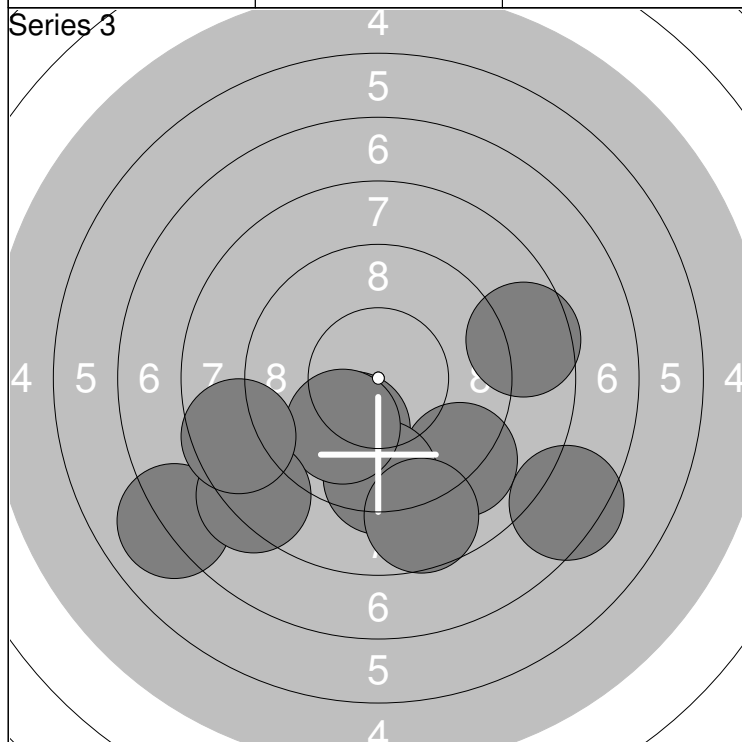

21: 10.1 ↙	26: 10.0 ↙	<b>Series</b> 84.0
22: 7.0 ←	27: 8.7 ↓	
23: 9.1 ↓	28: 8.3 ↙	<b>Total</b> 229.0
24: 7.4 →	29: 8.6 ←	
25: 9.4 ↓	30: 8.6 →	

31: 8.6 ↙	36: 8.5 ↓	<b>Series</b> 89.0
32: 10.5x ↓	37: 8.3 →	
33: 10.7x ↖	38: 8.7 ↓	<b>Total</b> 318.0
34: 10.5x ↗	39: 9.0 ↗	
35: 8.6 ↗	40: 10.1 ↓	

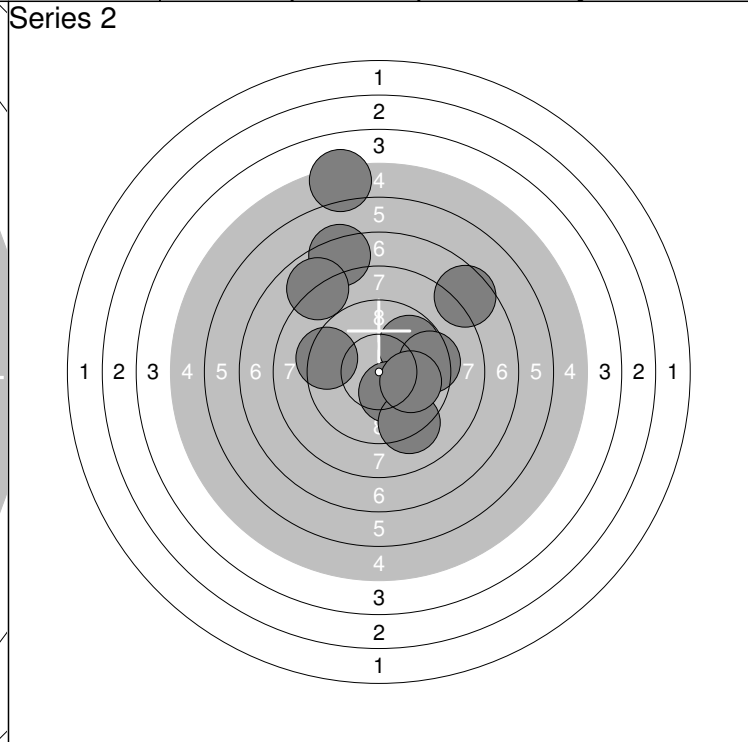
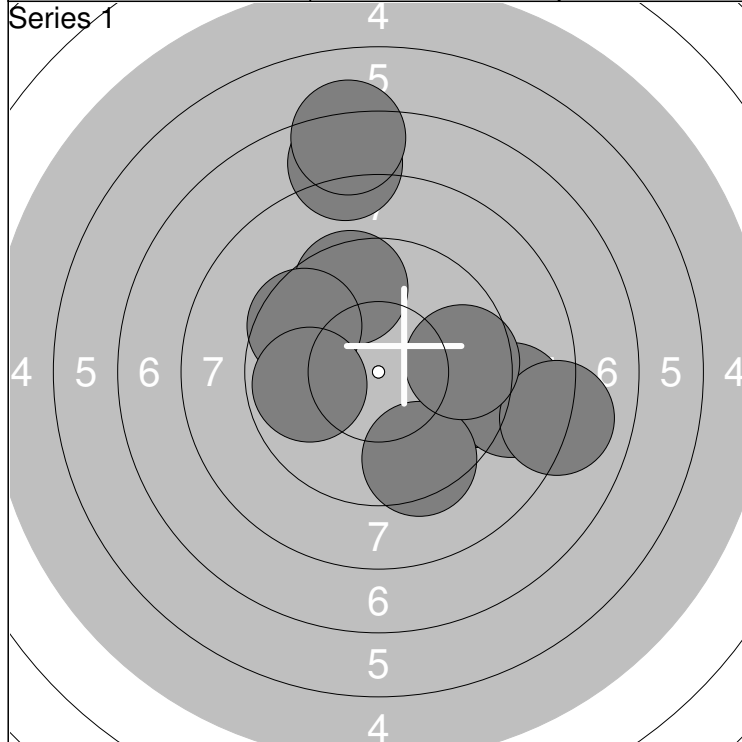

1: 9.4 →	6: 7.2 ↑	<b>Series</b>	84.0
2: 8.8 →	7: 8.1 →		
3: 9.6 ↑	8: 9.4 ↓	<b>Total</b>	84.0
4: 9.6 ↖	9: 9.8 ←		
5: 7.6 ↑	10: 9.6 →		

11: 5.3 ↑	16: 9.2 ↓	<b>Series</b>	82.0
12: 9.4 ←	17: 7.4 ↑		
13: 9.8 ↗	18: 9.4 →	<b>Total</b>	166.0
14: 7.6 ↗	19: 7.9 ↑		
15: 10.3x ↓	20: 10.0 →		

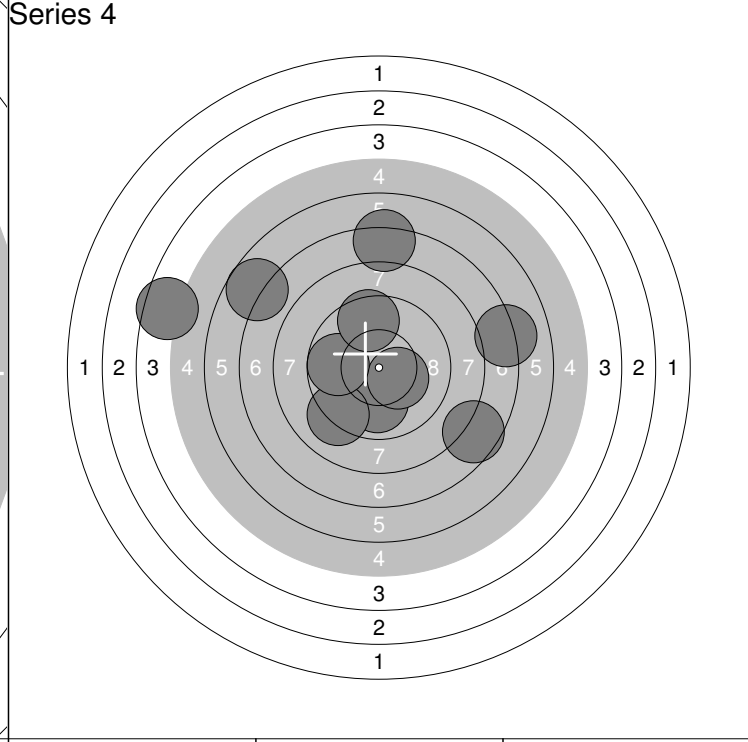
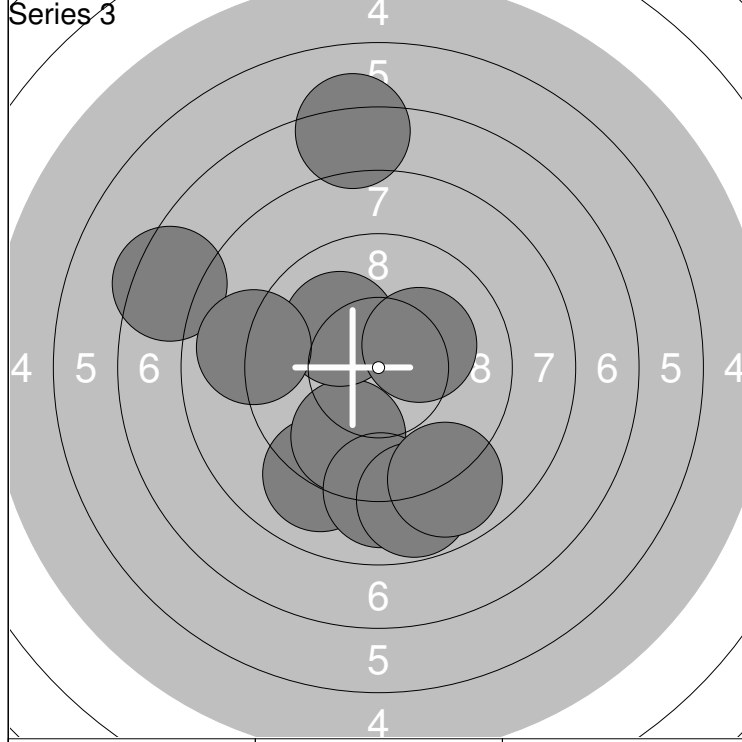

21: 9.0 ↘	26: 8.8 ↓	<b>Series</b>	86.0
22: 9.8 ↓	27: 8.9 ↓		
23: 10.1 ↖	28: 7.4 ←	<b>Total</b>	252.0
24: 9.0 ↓	29: 10.2x ↗		
25: 7.2 ↑	30: 9.0 ←		

31: 10.0 ↓	36: 7.1 →	<b>Series</b>	78.0
32: 6.7 ↖	37: 9.8 ←		
33: 9.1 ↘	38: 7.2 ↑	<b>Total</b>	330.0
34: 10.3x ↘	39: 4.5 ←		
35: 7.6 ↘	40: 9.6 ↑		

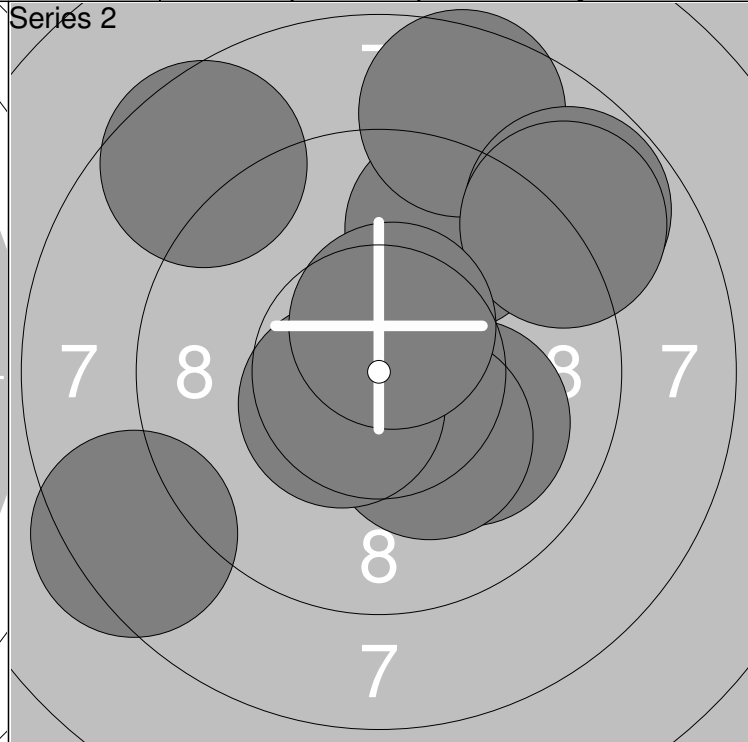
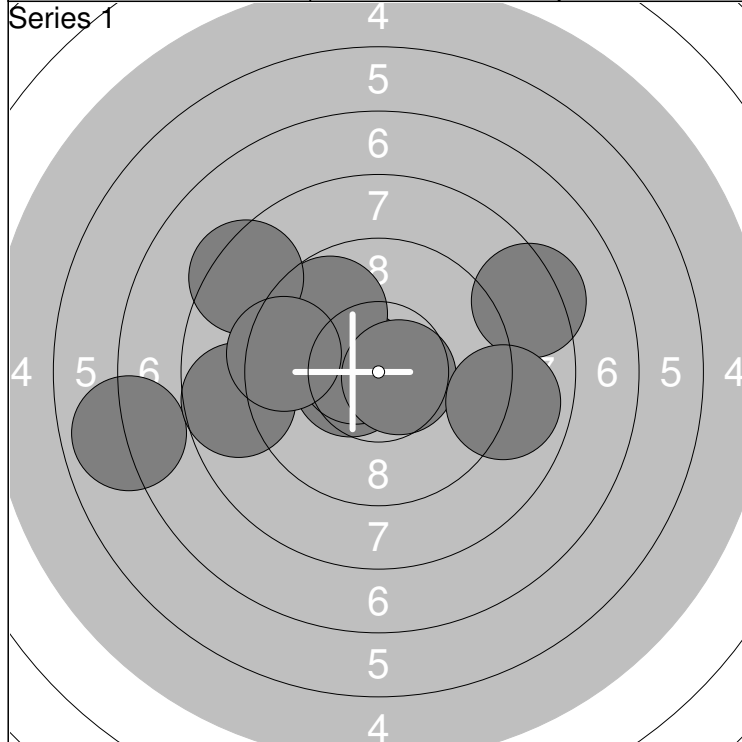

1: 6.9 ←	6: 10.6x →	<b>Series</b>	86.0
2: 10.5x ←	7: 8.4 ↗		
3: 8.3 ↗	8: 8.9 →	<b>Total</b>	86.0
4: 10.6x ←	9: 8.7 ←		
5: 9.8 ↘	10: 9.4 ←		

11: 10.1 →	16: 8.6 ↑	<b>Series</b>	89.0
12: 8.4 ←	17: 8.8 ↗		
13: 10.2x ↓	18: 8.6 ↖	<b>Total</b>	175.0
14: 9.6 ↑	19: 8.9 ↗		
15: 10.5x ↙	20: 10.5x ↑		

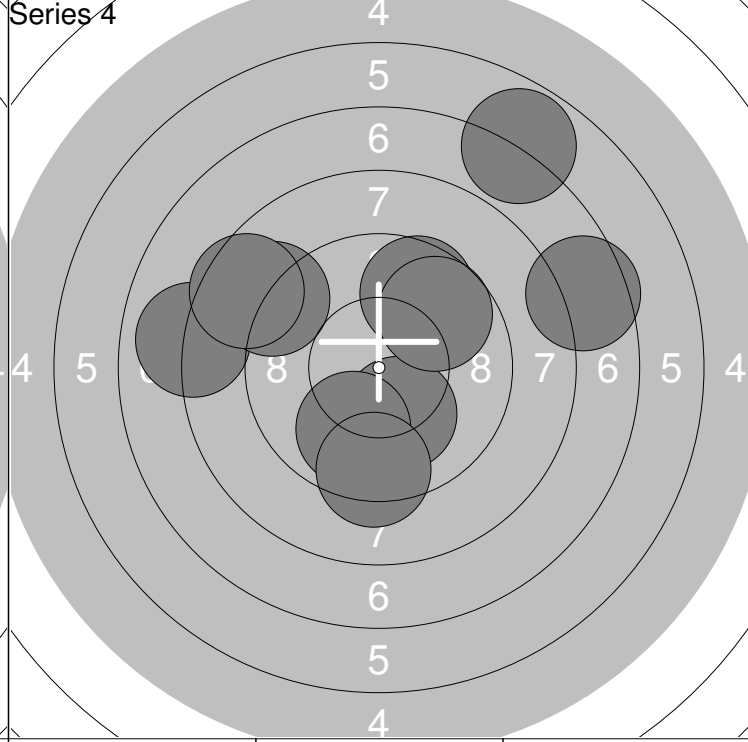
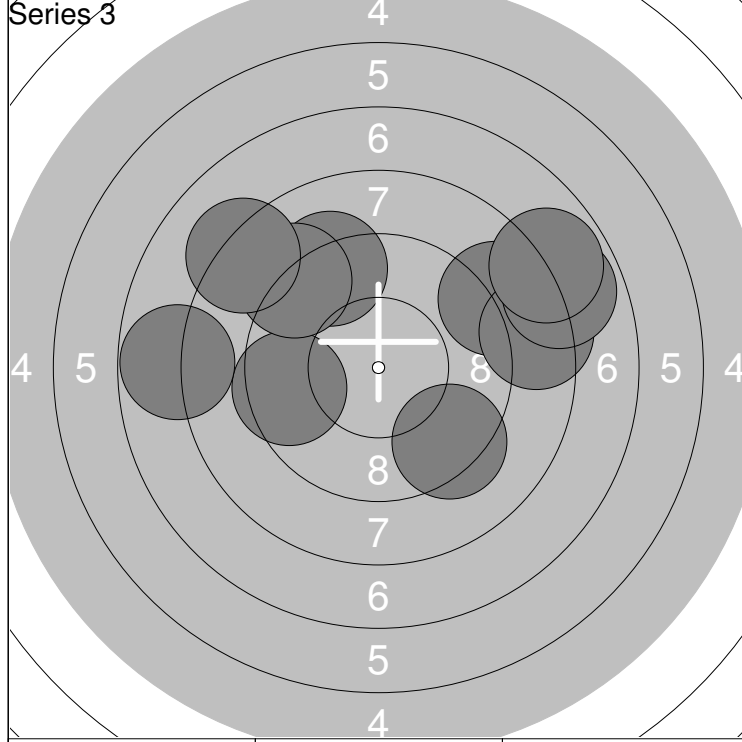

21: 9.2 ↗	26: 9.1 ↗	<b>Series</b>	81.0
22: 9.5 ←	27: 7.9 ↗		
23: 8.8 ↗	28: 8.2 ↖	<b>Total</b>	256.0
24: 9.3 ↓	29: 7.8 ↗		
25: 8.4 →	30: 7.8 ←		

31: 8.0 ←	36: 9.9 ↓	<b>Series</b>	84.0
32: 10.1 ↓	37: 9.6 ↑		
33: 6.8 ↑	38: 8.5 ↖	<b>Total</b>	340.0
34: 7.5 →	39: 9.3 ↓		
35: 9.0 ↖	40: 9.7 ↗		

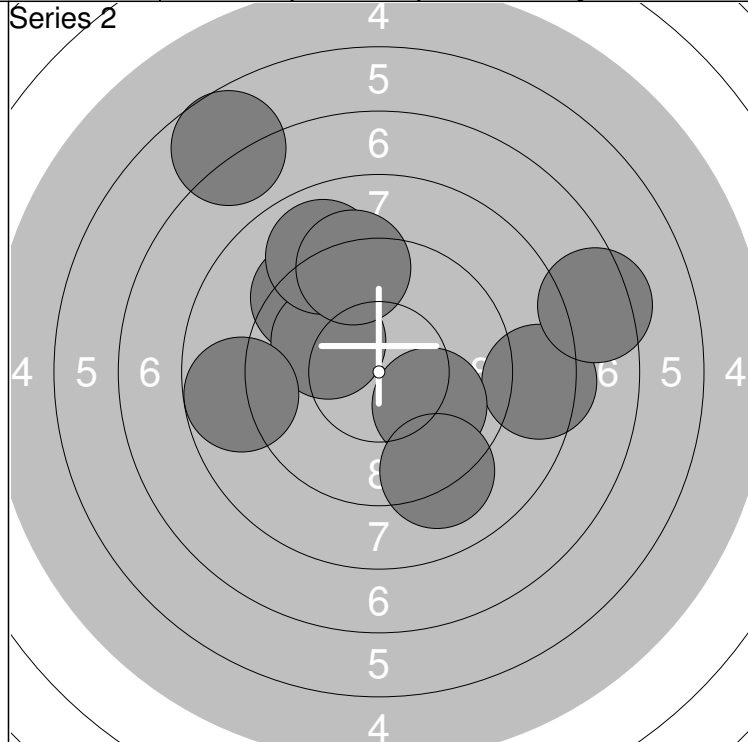
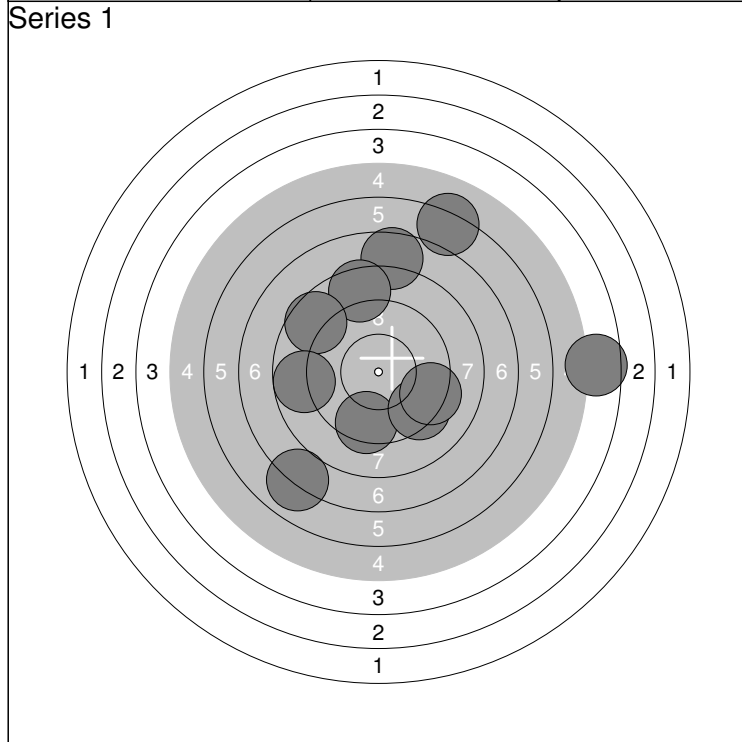

1: 9.4 ↓	6: 6.2 ↗	<b>Series</b> 75.0
2: 9.3 ↘	7: 8.6 ↗	
3: 7.6 ↑	8: 9.3 ↘	<b>Total</b> 75.0
4: 7.0 ↙	9: 4.6 →	
5: 8.5 ↑	10: 8.8 ←	

11: 8.4 →	16: 7.4 →	<b>Series</b> 85.0
12: 10.0 ↘	17: 9.0 ↗	
13: 9.3 ↗	18: 9.1 ↘	<b>Total</b> 160.0
14: 10.0 ↗	19: 8.7 ←	
15: 6.7 ↗	20: 9.2 ↑	

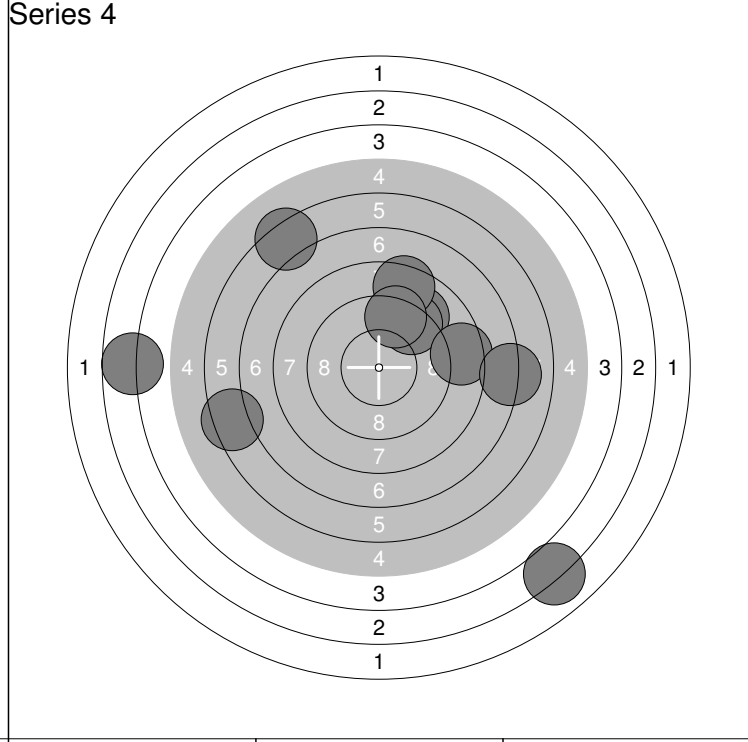
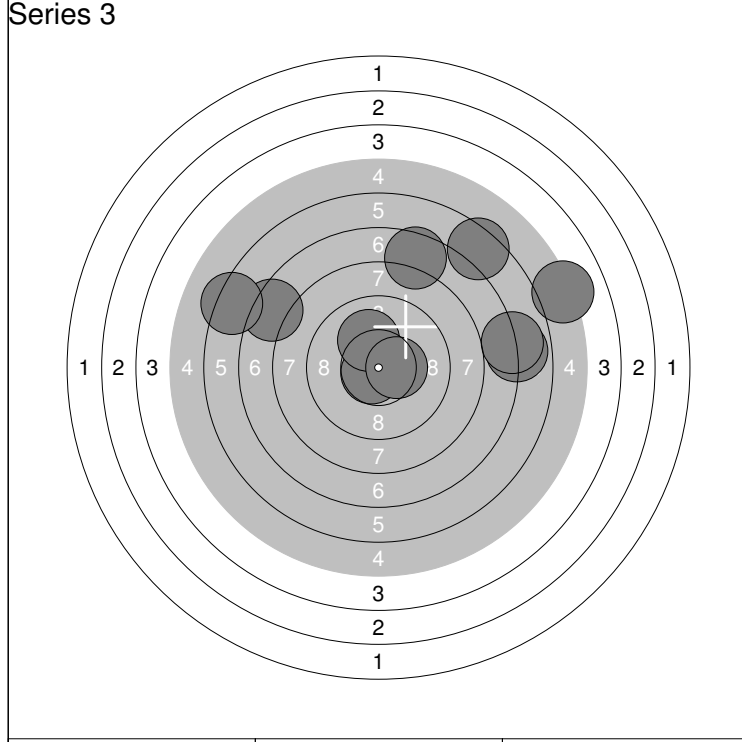

21: 5.1 →	26: 7.4 ↖	<b>Series</b> 74.0
22: 6.9 →	27: 10.4x →	
23: 7.6 ↑	28: 7.0 →	<b>Total</b> 234.0
24: 10.7x ↙	29: 6.3 ↖	
25: 10.1 ↑	30: 6.4 ↗	

31: 3.0 ↘	36: 8.5 ↑	<b>Series</b> 68.0
32: 9.1 ↗	37: 9.4 ↑	
33: 9.4 ↗	38: 6.3 ↖	<b>Total</b> 302.0
34: 6.4 ←	39: 7.1 →	
35: 8.5 →	40: 3.7 ←	

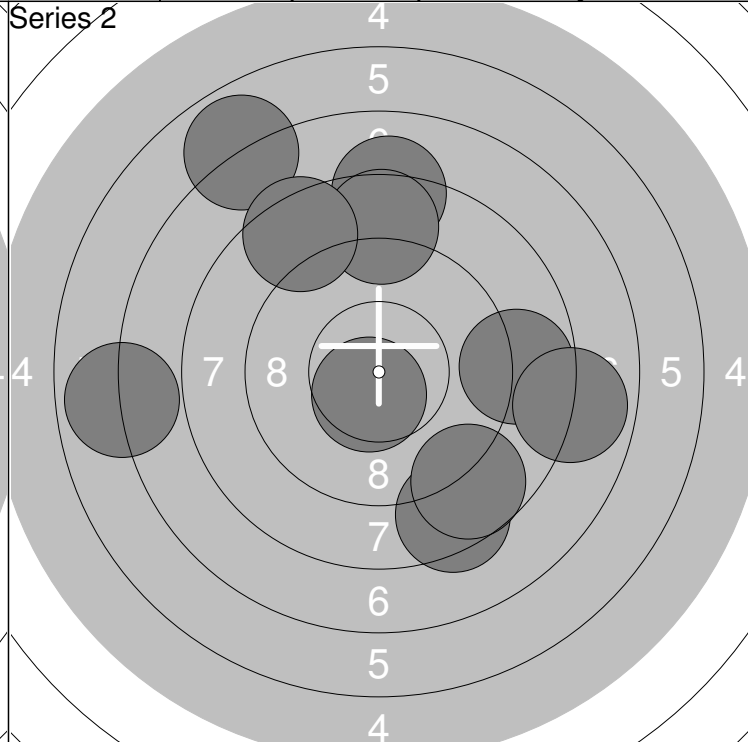
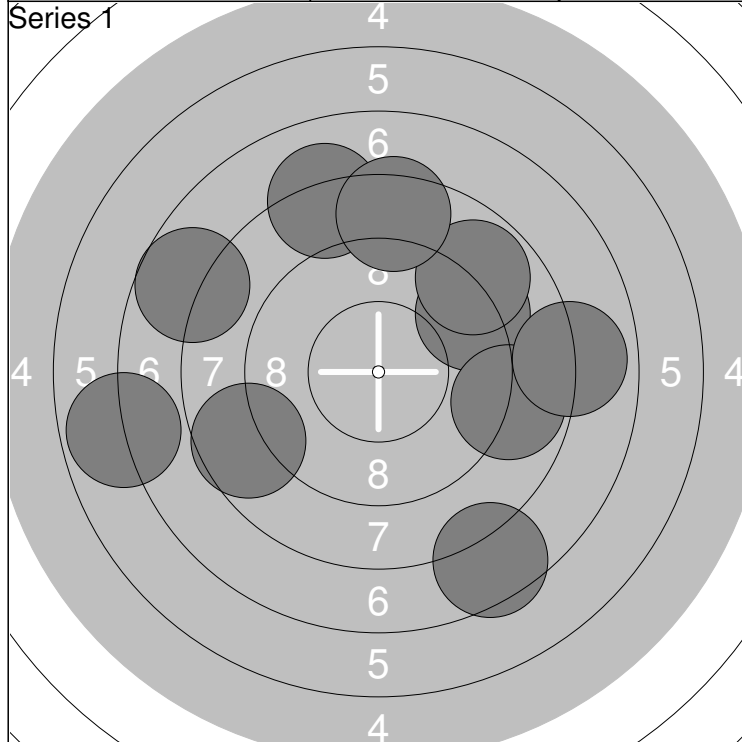

1: 8.7 ↙	6: 7.5 ↘	Series 76.0
2: 7.7 ↖	7: 8.8 →	
3: 6.8 ←	8: 8.2 ↗	Total 76.0
4: 9.2 ↗	9: 8.5 ↗	
5: 8.9 ↗	10: 7.9 →	

11: 8.8 →	16: 8.1 ↑	Series 77.0
12: 10.6x ↘	17: 8.7 ↑	
13: 7.9 →	18: 6.9 ↗	Total 153.0
14: 8.4 ↘	19: 8.7 ↘	
15: 6.9 ←	20: 8.5 ↗	

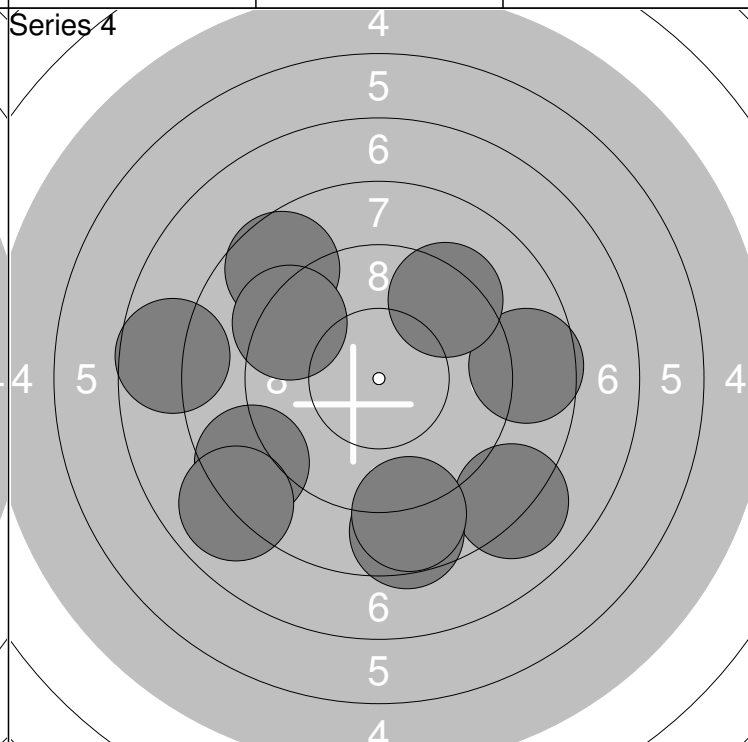
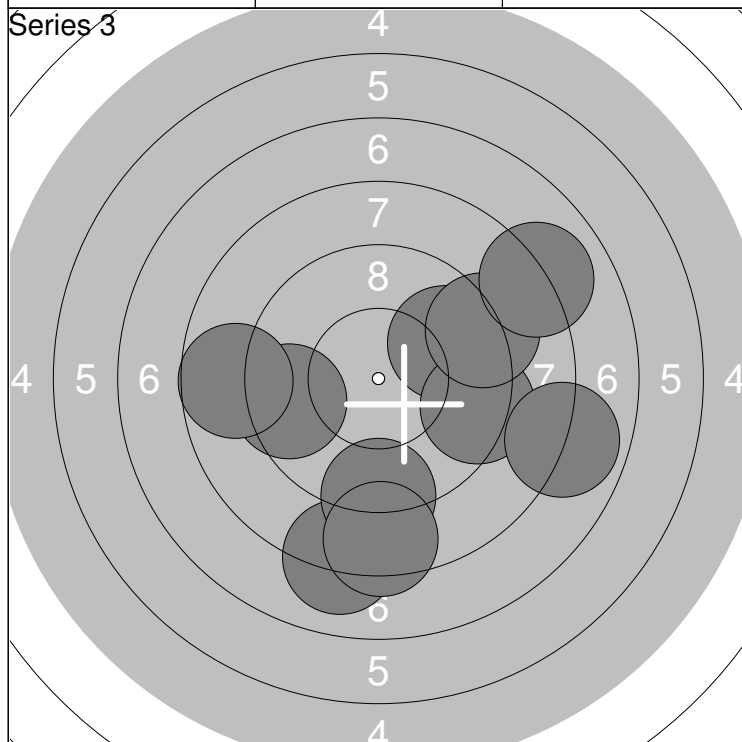

21: 9.8 ↗	26: 8.4 ↓	Series 84.0
22: 9.3 →	27: 8.0 →	
23: 9.1 ↗	28: 7.9 →	Total 237.0
24: 8.1 ↓	29: 9.5 ←	
25: 9.1 ↓	30: 8.7 ←	

31: 8.1 ↘	36: 8.5 ↓	Series 81.0
32: 8.5 ↙	37: 8.0 ↙	
33: 8.6 →	38: 8.8 ↓	Total 318.0
34: 9.3 ↗	39: 8.7 ↗	
35: 7.7 ←	40: 9.3 ↙	

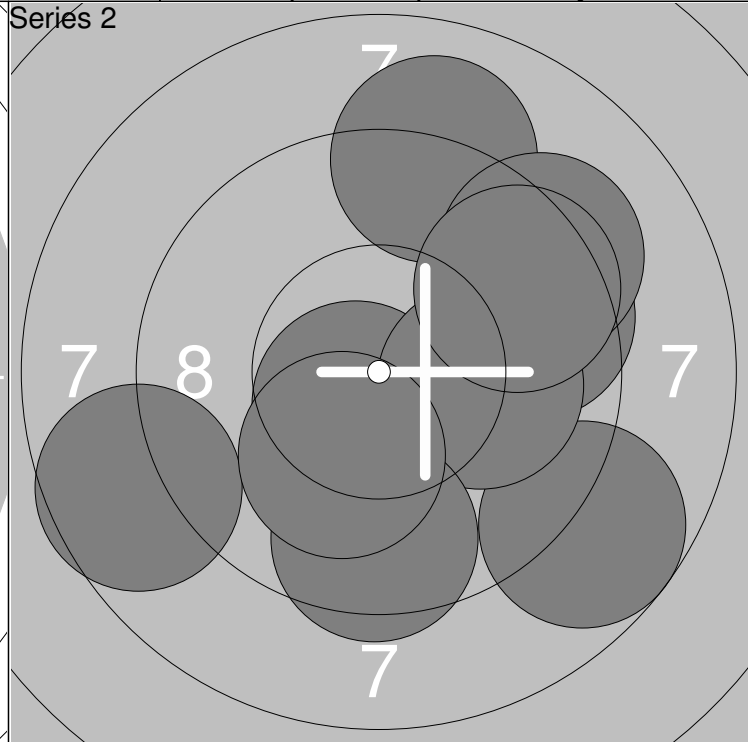
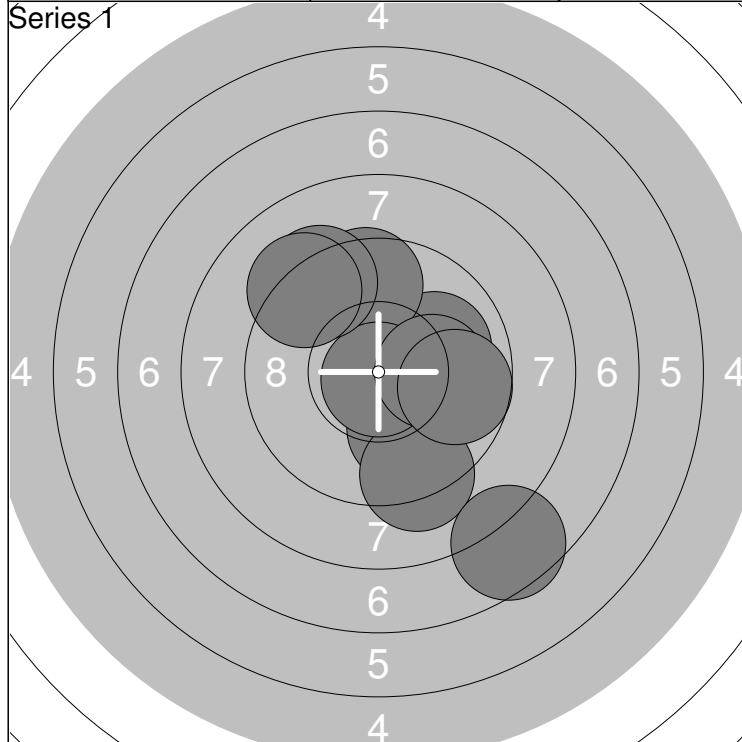

1: 10.0 →	6: 10.8x ↓	<b>Series</b> 92.0
2: 10.0 ↓	7: 10.1 →	
3: 9.2 ↓	8: 9.7 →	<b>Total</b> 92.0
4: 7.6 ↓	9: 9.3 ↗	
5: 9.6 ↑	10: 9.2 ↗	

11: 8.6 ←	16: 9.0 ↑	<b>Series</b> 91.0
12: 9.5 →	17: 9.2 ↗	
13: 8.7 ↓	18: 9.5 ↓	<b>Total</b> 183.0
14: 10.6x ↓	19: 9.5 ↗	
15: 10.1 →	20: 10.1 ↓	

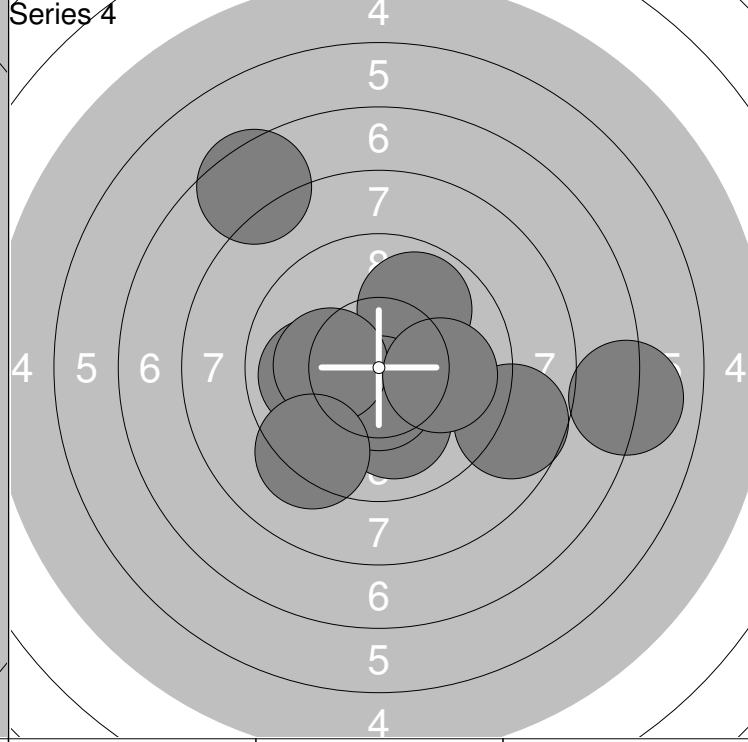
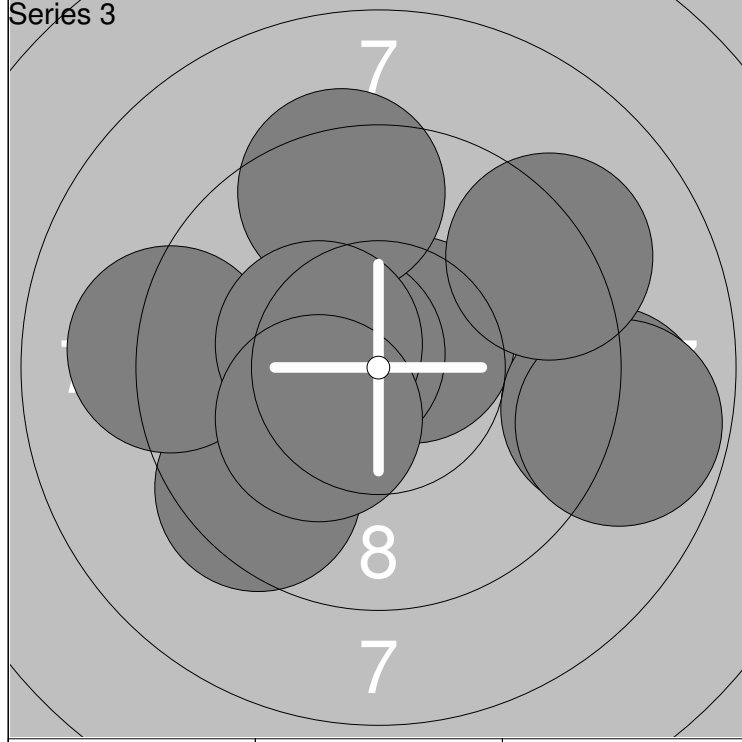

21: 9.5 ↙	26: 8.8 →	<b>Series</b> 93.0
22: 10.6x ↗	27: 9.2 ↗	
23: 10.6x ↖	28: 9.1 ←	<b>Total</b> 276.0
24: 9.0 →	29: 10.4x ↖	
25: 9.4 ↑	30: 10.3x ↙	

31: 8.7 →	36: 7.1 →	<b>Series</b> 89.0
32: 9.9 ↗	37: 10.2x ←	
33: 10.1 ↓	38: 9.3 ↙	<b>Total</b> 365.0
34: 10.6x ↓	39: 7.5 ↗	
35: 9.9 ←	40: 10.0 →	

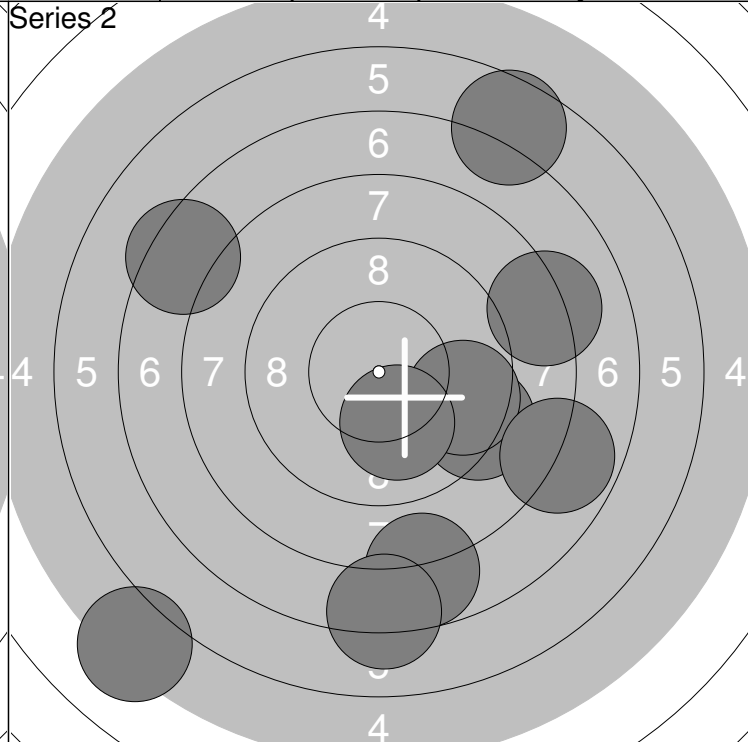
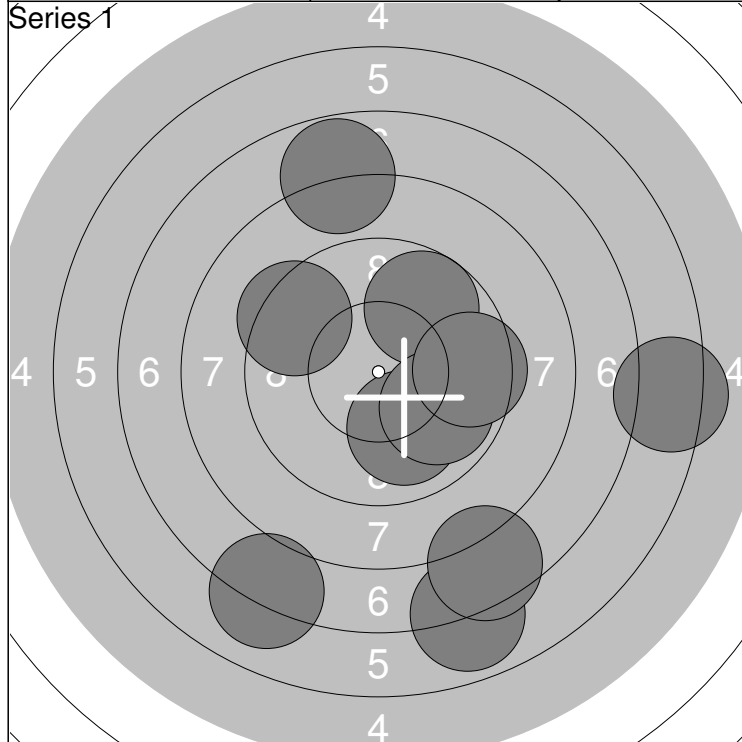

1: 9.4 ↗	6: 9.7 ↗	<b>Series</b> 79.0
2: 7.1 ↘	7: 9.9 ↘	
3: 6.9 ↘	8: 6.3 →	<b>Total</b> 79.0
4: 7.5 ↘	9: 9.5 →	
5: 10.0 ↘	10: 7.8 ↑	

11: 7.8 ↓	16: 8.2 →	<b>Series</b> 75.0
12: 7.2 ↓	17: 10.1 ↓	
13: 7.4 ↗	18: 6.6 ↗	<b>Total</b> 154.0
14: 9.2 ↘	19: 7.8 →	
15: 9.6 →	20: 5.2 ↘	

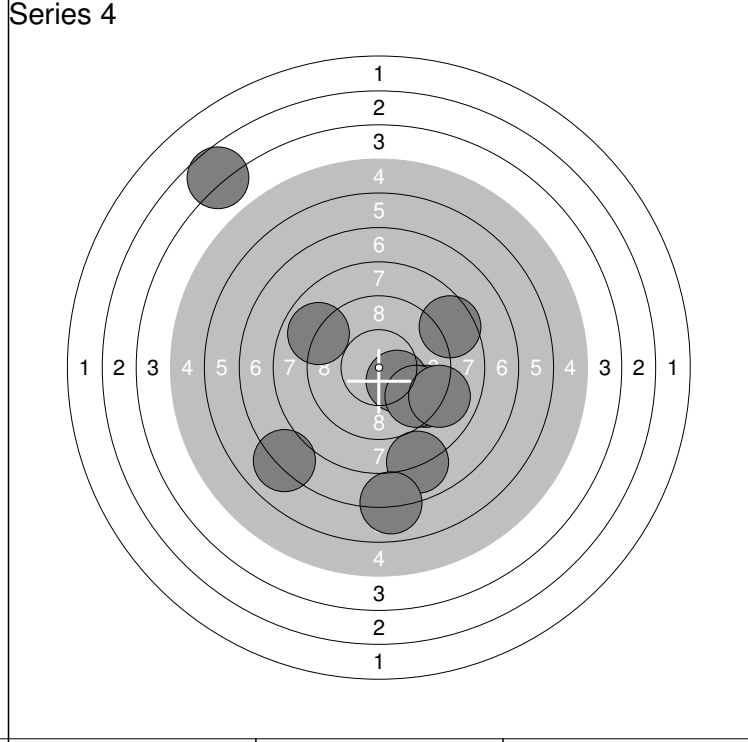
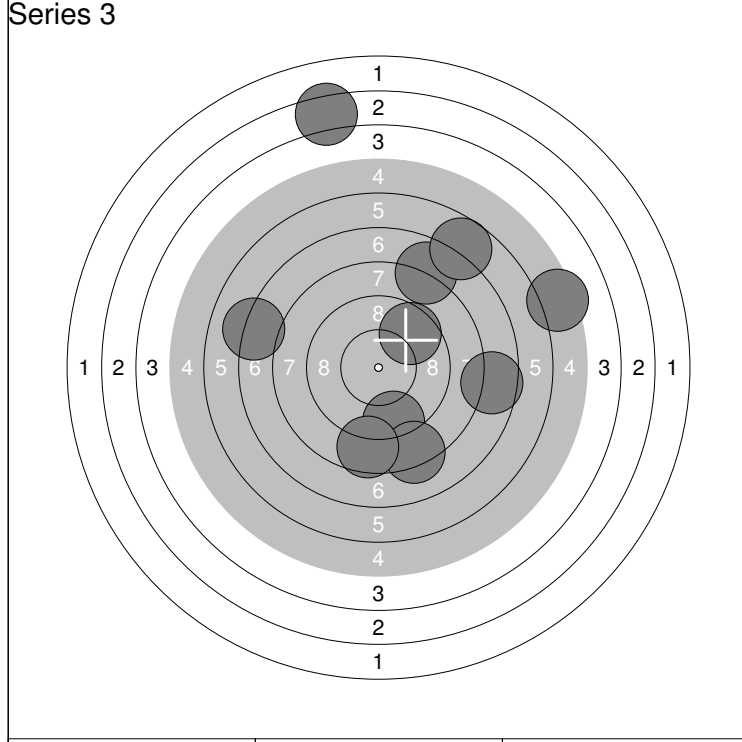

21: 9.3 ↓	26: 6.7 ↗	<b>Series</b> 69.0
22: 8.2 ↓	27: 5.3 →	
23: 3.4 ↑	28: 7.6 →	<b>Total</b> 223.0
24: 7.9 ↗	29: 7.2 ←	
25: 8.6 ↓	30: 9.6 ↗	

31: 8.6 ↗	36: 3.6 ↗	<b>Series</b> 78.0
32: 8.9 ↗	37: 9.4 ↘	
33: 7.1 ↘	38: 7.0 ↓	<b>Total</b> 301.0
34: 8.0 ↓	39: 9.6 ↘	
35: 10.3x ↘	40: 9.0 ↘	

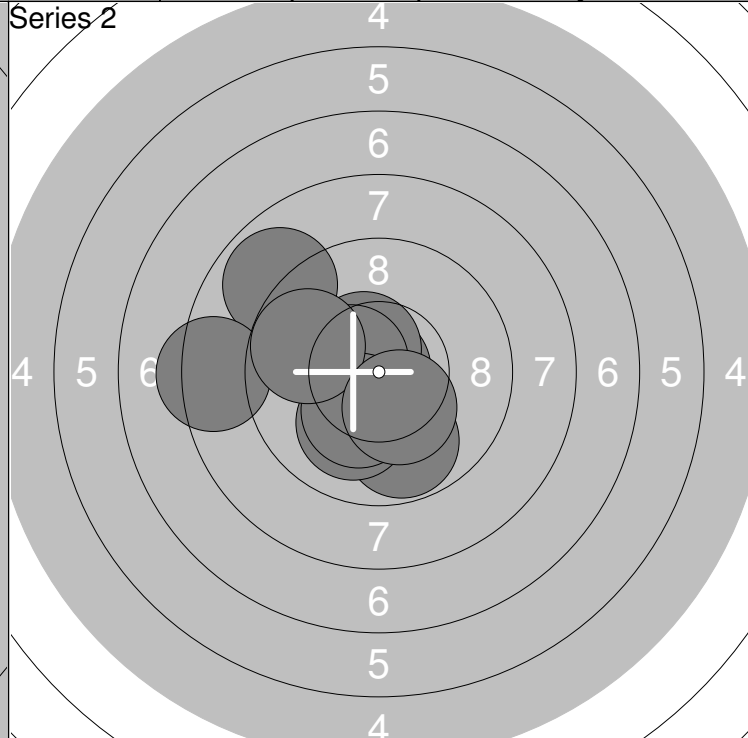
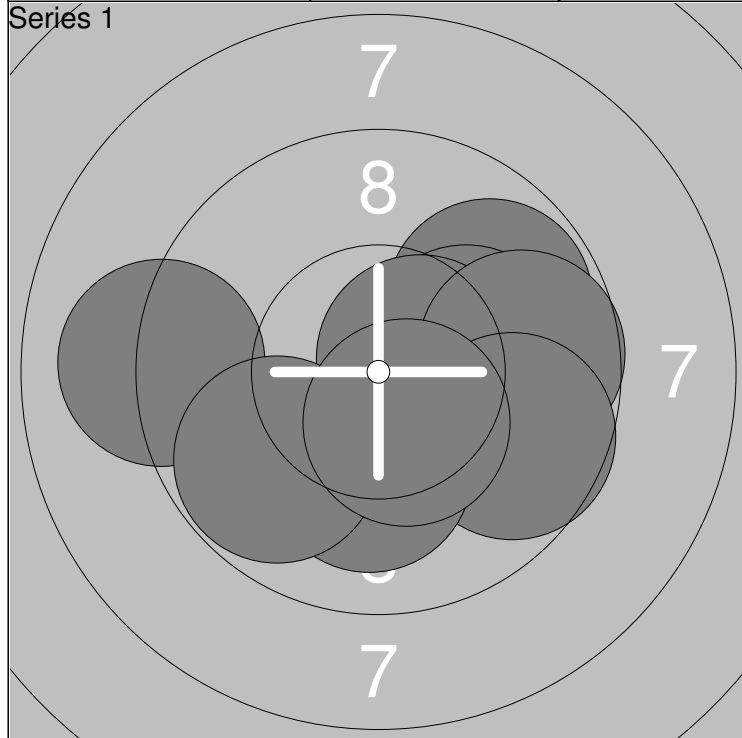

1: 9.8 ↗	6: 9.7 ↘	<b>Series</b> 95.0
2: 10.3x →	7: 9.1 ←	
3: 10.2x →	8: 10.1 ↓	<b>Total</b> 95.0
4: 10.6x →	9: 9.8 ↙	
5: 9.7 →	10: 10.5x ↓	

11: 8.9 ↗	16: 8.3 ←	<b>Series</b> 94.0
12: 10.9x ↖	17: 10.5x ↖	
13: 9.8 ↓	18: 10.3x ↓	<b>Total</b> 189.0
14: 10.5x ↗	19: 9.8 ←	
15: 10.1 ↓	20: 10.3x ↓	

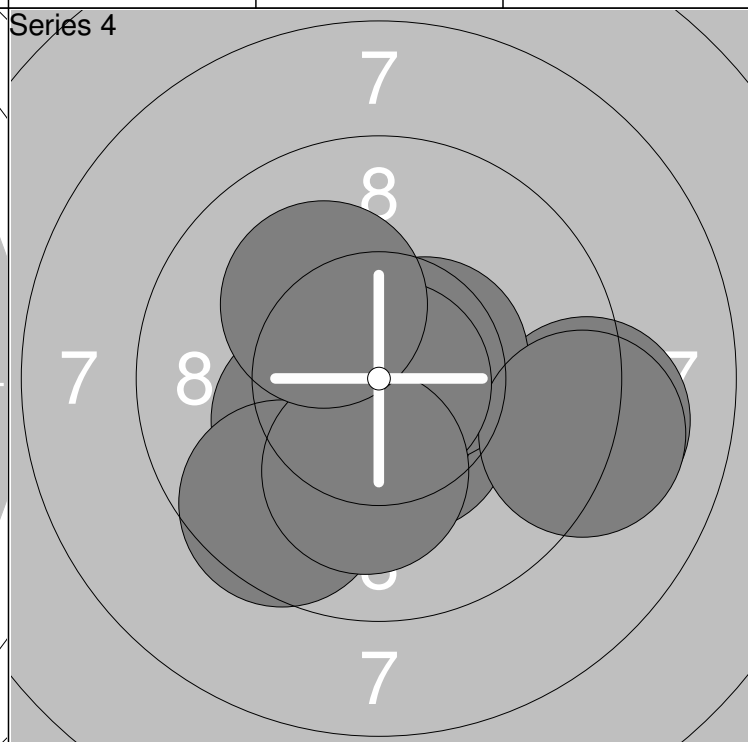
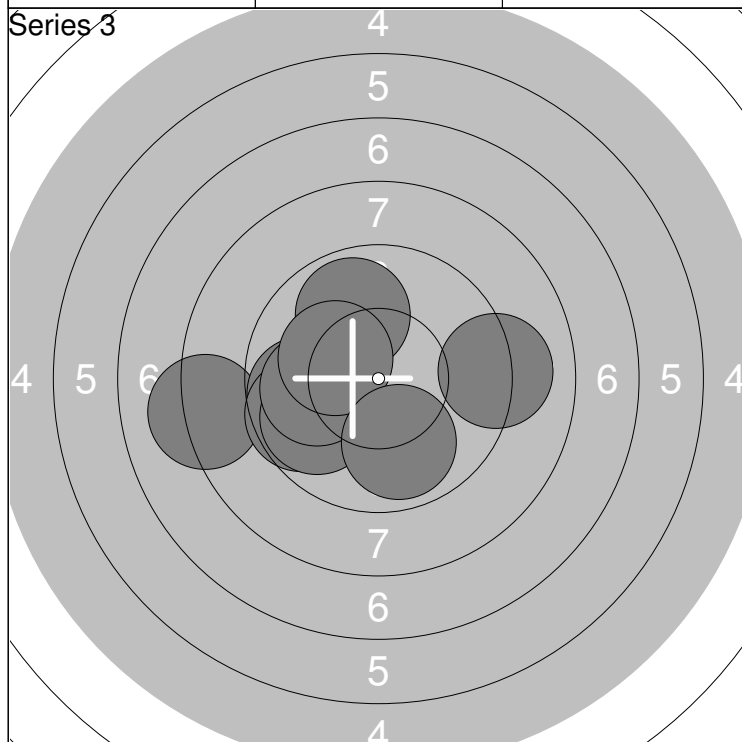

21: 8.2 ←	26: 10.0 ←	<b>Series</b> 92.0
22: 9.8 ←	27: 9.9 ↗	
23: 9.6 ←	28: 10.2x ↖	<b>Total</b> 281.0
24: 10.0 ←	29: 9.1 →	
25: 9.8 ↙	30: 9.9 ↓	

31: 10.4x ↓	36: 9.1 →	<b>Series</b> 97.0
32: 10.7x ↓	37: 10.9x ↘	
33: 9.1 →	38: 9.6 ↙	<b>Total</b> 378.0
34: 10.5x →	39: 10.1 ↓	
35: 10.3x ↖	40: 10.2x ↖	



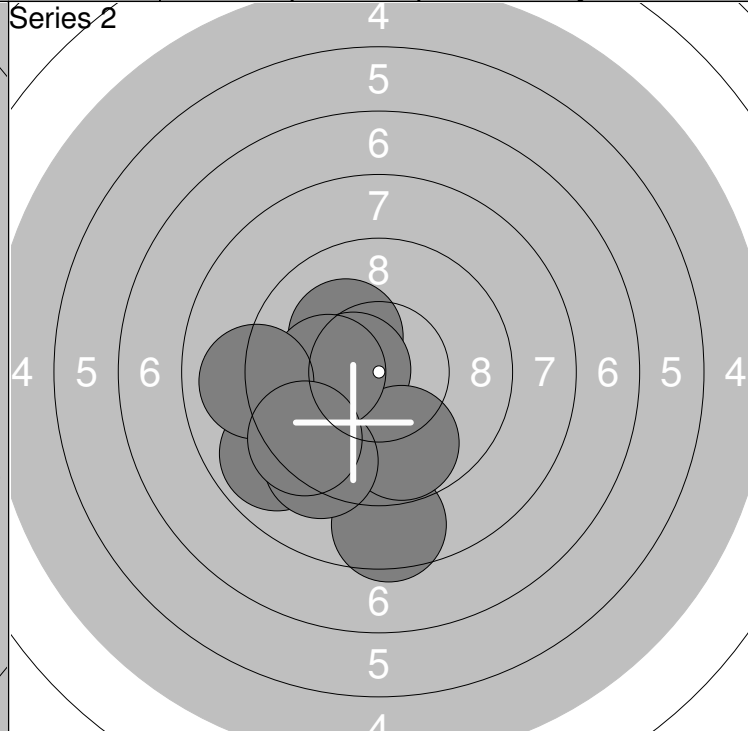
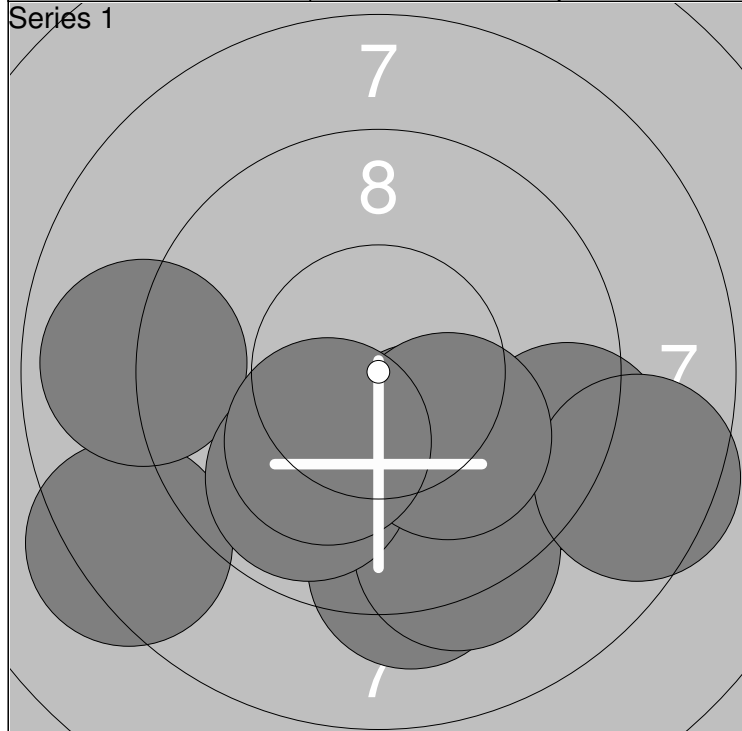

1: 9.2 →	6: 8.9 ←	<b>Series</b>	90.0
2: 9.2 ↓	7: 8.5 →		
3: 10.2x ↓	8: 9.8 ↓	<b>Total</b>	90.0
4: 9.3 ↓	9: 10.1 ↓		
5: 8.3 ↙	10: 10.2x ↘		

11: 10.2x ↗	16: 9.8 ↓	<b>Series</b>	91.0
12: 10.5x ←	17: 9.3 ↓		
13: 9.3 ↘	18: 10.2x ←	<b>Total</b>	181.0
14: 8.6 ↓	19: 9.0 ←		
15: 8.9 ↙	20: 9.4 ↘		

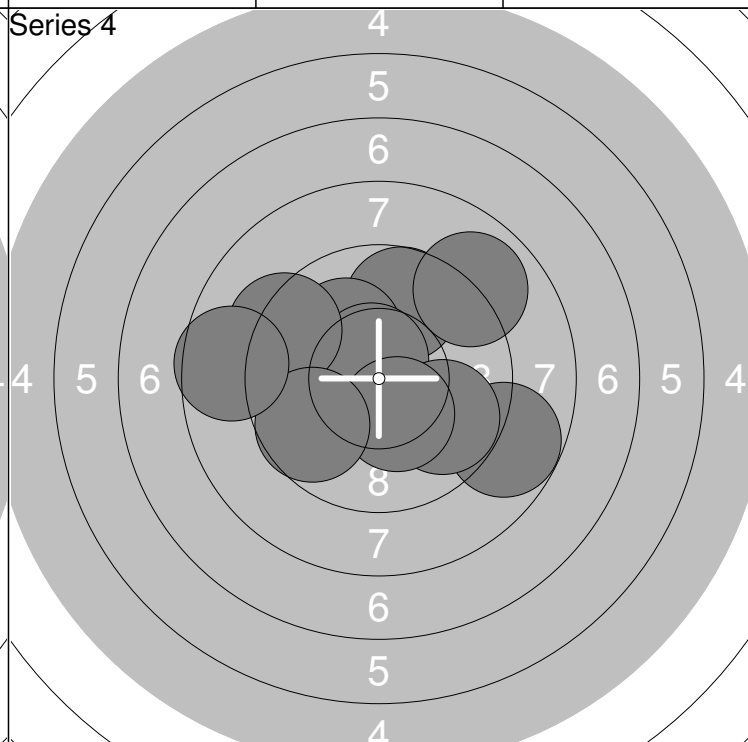
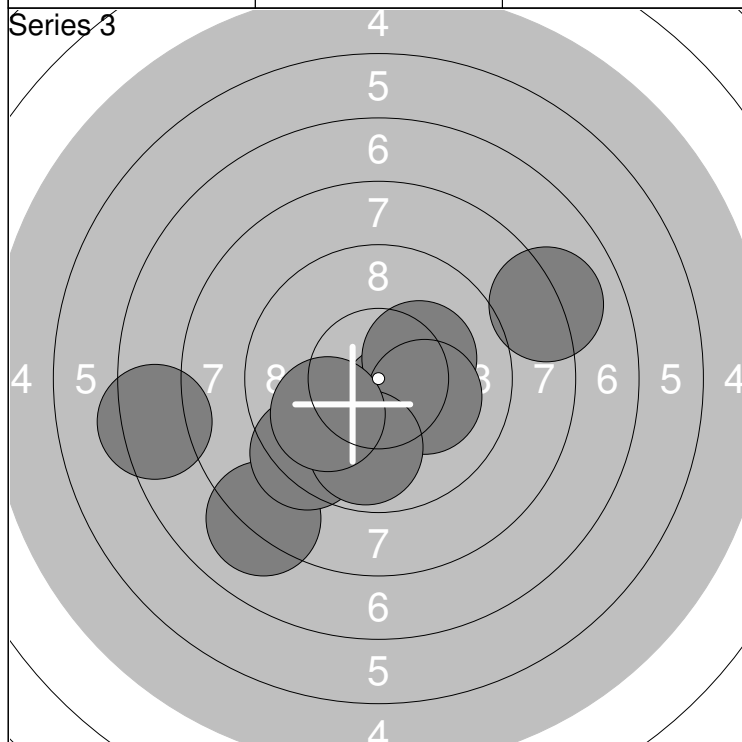

21: 10.5x ↓	26: 10.2x →	<b>Series</b>	90.0
22: 9.7 ↙	27: 8.1 →		
23: 8.1 ↘	28: 9.9 ↓	<b>Total</b>	271.0
24: 9.3 ↘	29: 7.4 ←		
25: 10.2x →	30: 10.0 ↙		

31: 9.7 ↗	36: 8.9 ↗	<b>Series</b>	90.0
32: 10.1 ↗	37: 9.8 ↓		
33: 10.6x ↗	38: 10.3x ↓	<b>Total</b>	361.0
34: 9.3 ↙	39: 9.7 ↙		
35: 8.8 ↘	40: 8.6 ←		

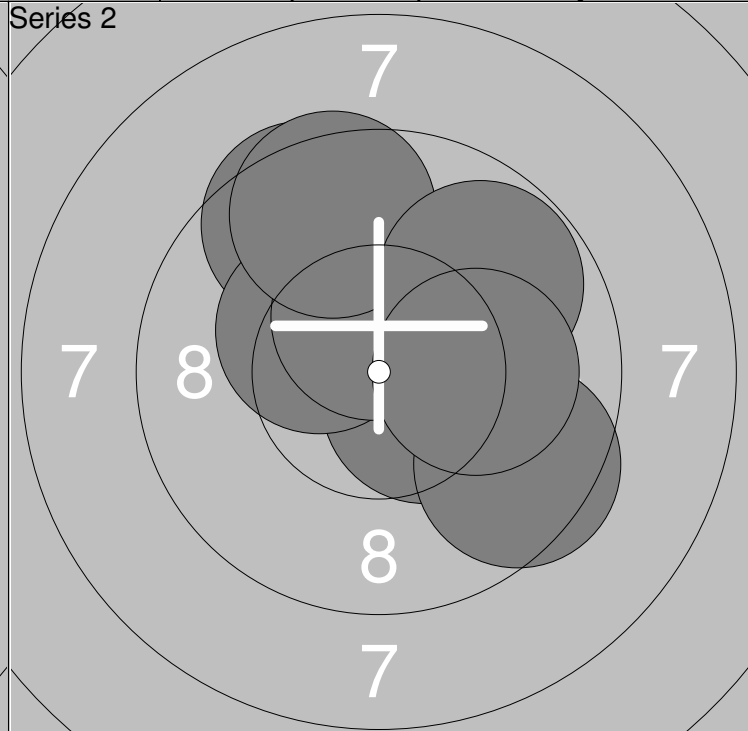
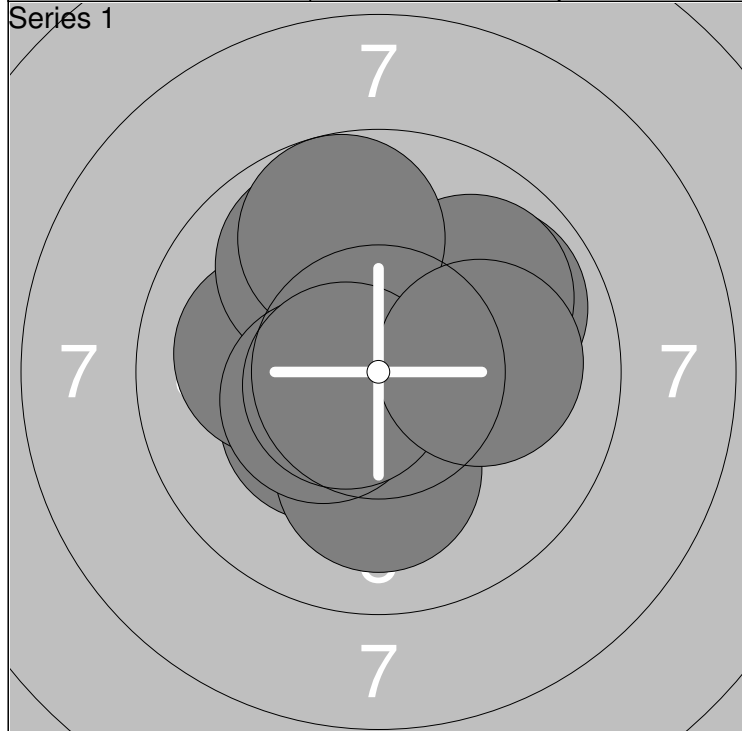

1: 9.9 ↗	6: 10.1 ↓	Series 96.0
2: 9.9 ↗	7: 9.7 ↗	
3: 10.3x ↙	8: 10.4x ↙	Total 96.0
4: 10.0 ←	9: 10.6x ↙	
5: 9.9 ↗	10: 10.1 →	

11: 10.5x ↘	16: 10.3x ↖	Series 96.0
12: 9.5 ↘	17: 10.5x ↑	
13: 10.1 ↗	18: 9.5 ↑	Total 192.0
14: 9.5 ↗	19: 9.8 ↗	
15: 10.4x ↗	20: 10.1 →	

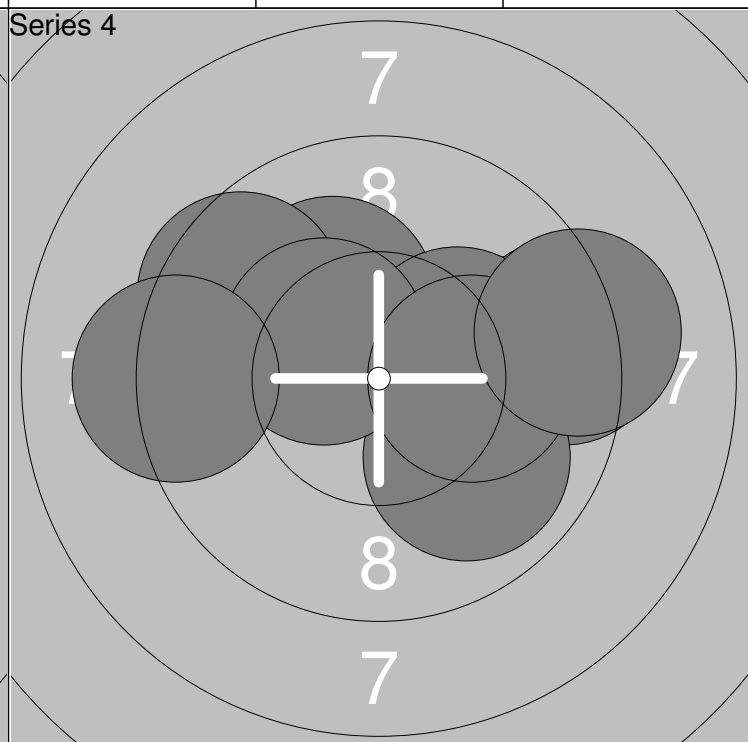
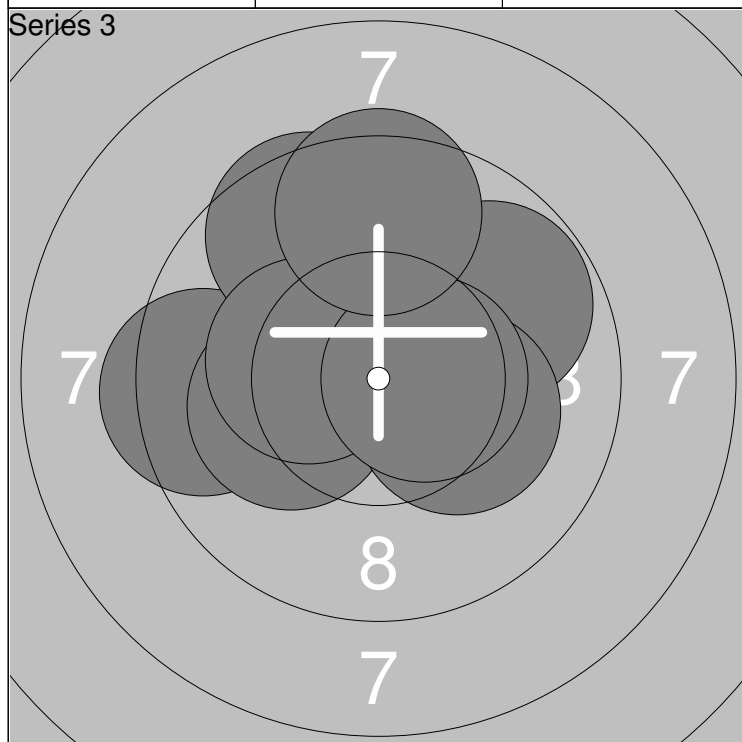

21: 9.4 ←	26: 9.8 ↗	Series 95.0
22: 9.9 ↑	27: 10.3x ↙	
23: 9.6 ↗	28: 10.2x ↘	Total 287.0
24: 10.0 ↗	29: 10.5x →	
25: 10.2x ↙	30: 9.5 ↑	

31: 9.9 →	36: 10.2x →	Series 94.0
32: 10.2x ↗	37: 10.4x ↖	
33: 9.5 ↖	38: 10.1 →	Total 381.0
34: 9.3 →	39: 9.2 →	
35: 9.9 ↘	40: 9.2 ←	

Relay <b>4</b>	Lane <b>13</b>	<b>Elina Takku</b>
-------------------	-------------------	--------------------

Air	PuKu	AR N16
-----	------	--------

8.-9.2.2014	Aluemestaruuskilpailut	Kankaanpään Ampumaurheilijat
-------------	------------------------	------------------------------

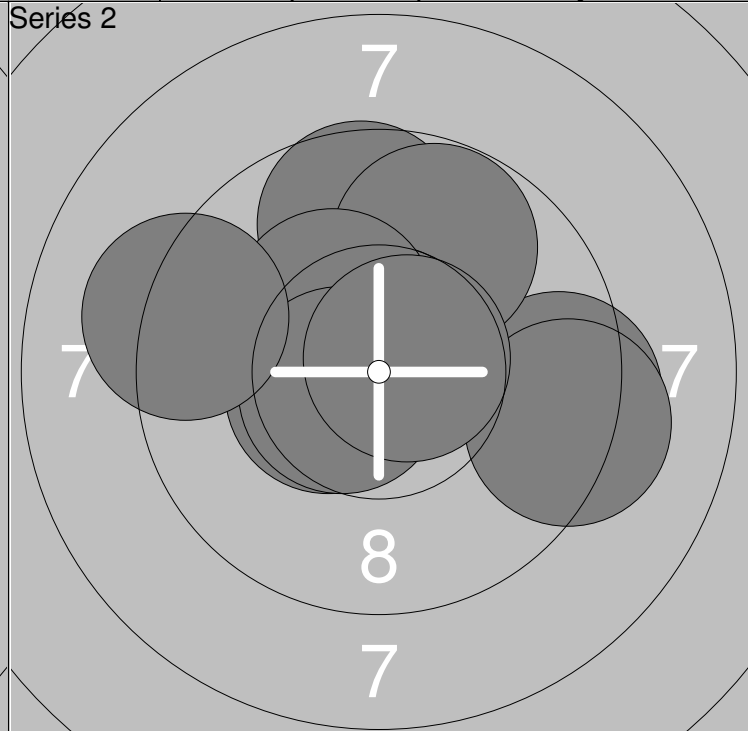
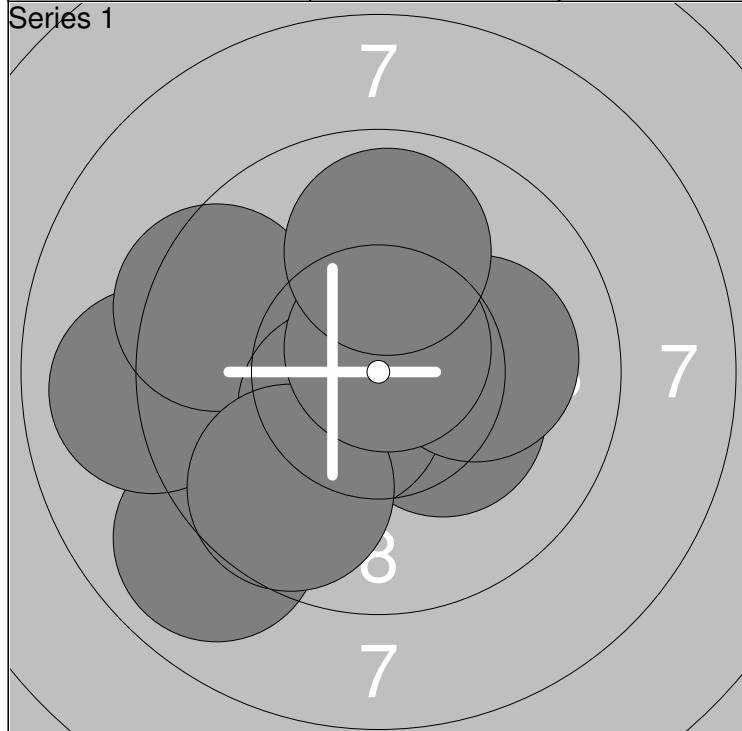

1: 10.4x ↖	6: 10.5x ↙	Series	95.0
2: 9.0 ↙	7: 9.7 ↘		
3: 9.0 ←	8: 10.1 →	Total	95.0
4: 10.3x ↘	9: 10.7x ↗		
5: 9.4 ↖	10: 9.9 ↗		

11: 10.5x ←	16: 10.3x ↗	Series	95.0
12: 9.4 →	17: 10.6x ↙		
13: 9.7 ↗	18: 9.2 ←	Total	190.0
14: 9.7 ↗	19: 9.3 →		
15: 10.7x ↗	20: 10.7x ↗		

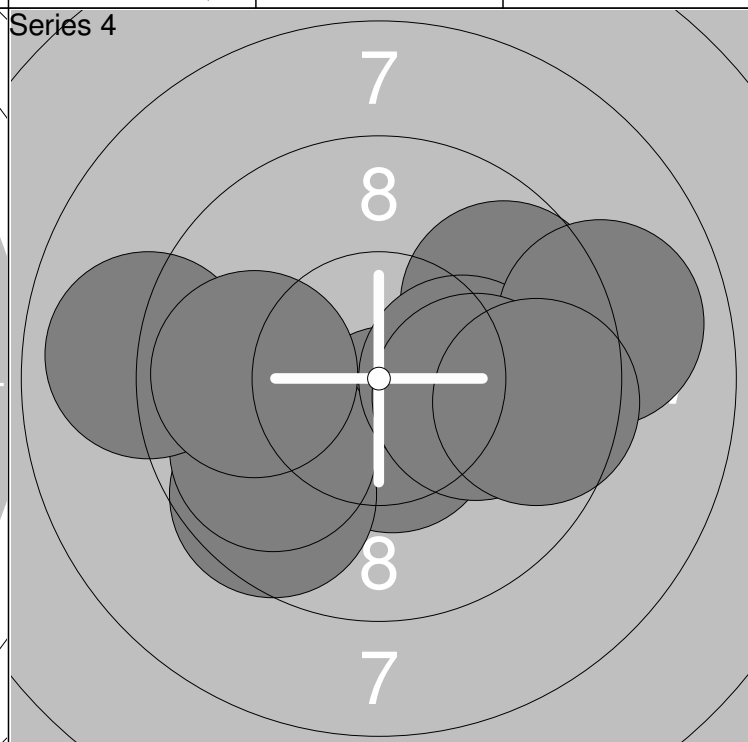
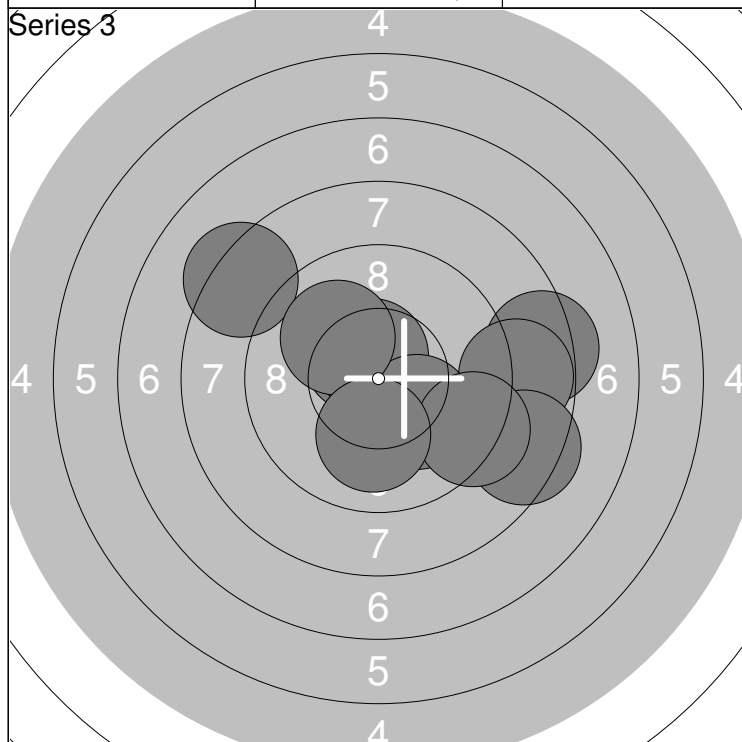

21: 8.3 →	26: 8.4 ↘	Series	91.0
22: 8.3 ↗	27: 10.2x ↘		
23: 8.8 →	28: 10.0 ↗	Total	281.0
24: 10.5x ↗	29: 9.3 ↘		
25: 10.6x ↗	30: 10.1 ↘		

31: 9.7 ↗	36: 9.0 →	Series	93.0
32: 10.5x ↘	37: 9.0 ←		
33: 9.6 ↙	38: 10.1 →	Total	374.0
34: 9.9 ↙	39: 9.9 ←		
35: 10.2x →	40: 9.6 →		

Relay <b>4</b>	Lane <b>14</b>	<b>Emma Takku</b>
-------------------	-------------------	-------------------

Air	PuKu	AR N16
-----	------	--------

8.-9.2.2014	Aluemestaruuskilpailut	Kankaanpään Ampumaurheilijat
-------------	------------------------	------------------------------

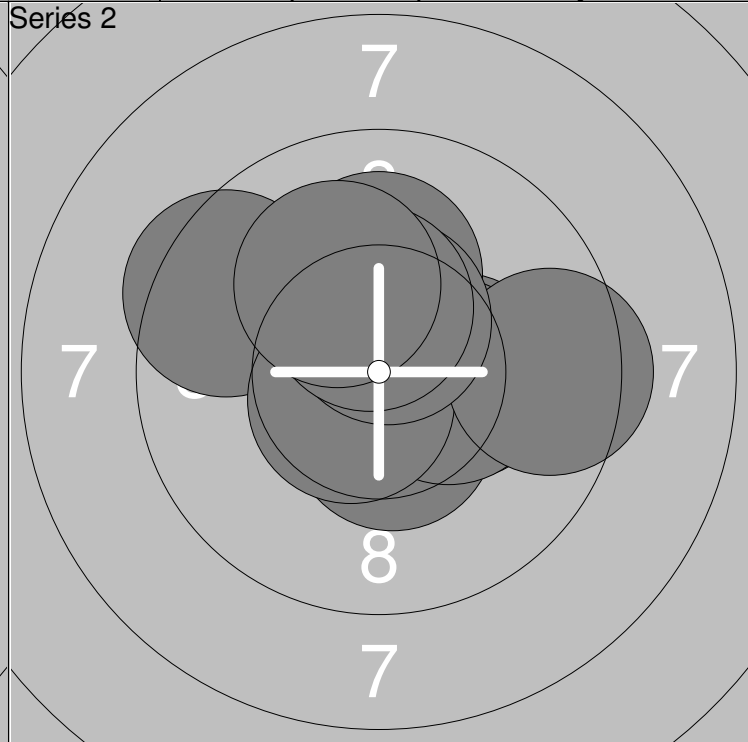
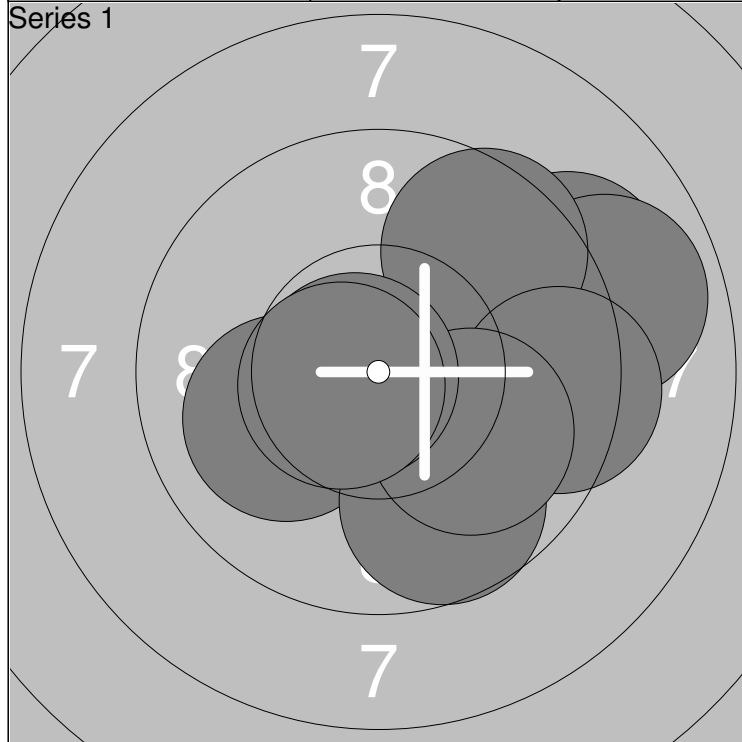

1: 9.1 ↗	6: 9.6 ↗	Series 94.0
2: 10.7x ↓	7: 9.4 →	
3: 8.9 →	8: 10.0 ↘	Total 94.0
4: 10.0 ↙	9: 10.8x ←	
5: 9.7 ↓	10: 10.6x ←	

11: 9.5 ↖	16: 9.5 →	Series 98.0
12: 10.5x ↓	17: 10.1 ↑	
13: 10.3x →	18: 10.5x ↑	Total 192.0
14: 10.4x →	19: 10.4x ↑	
15: 10.6x ↙	20: 10.1 ↖	

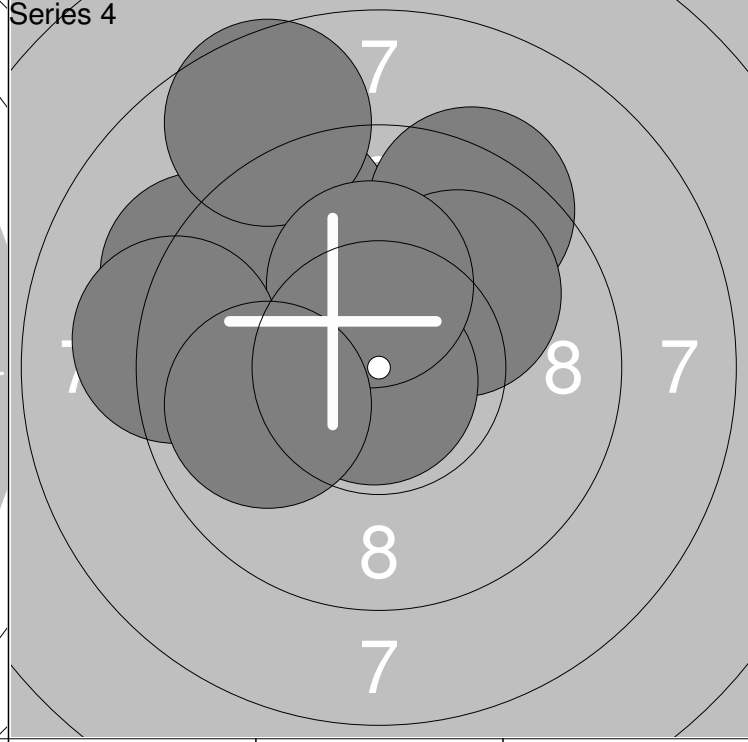
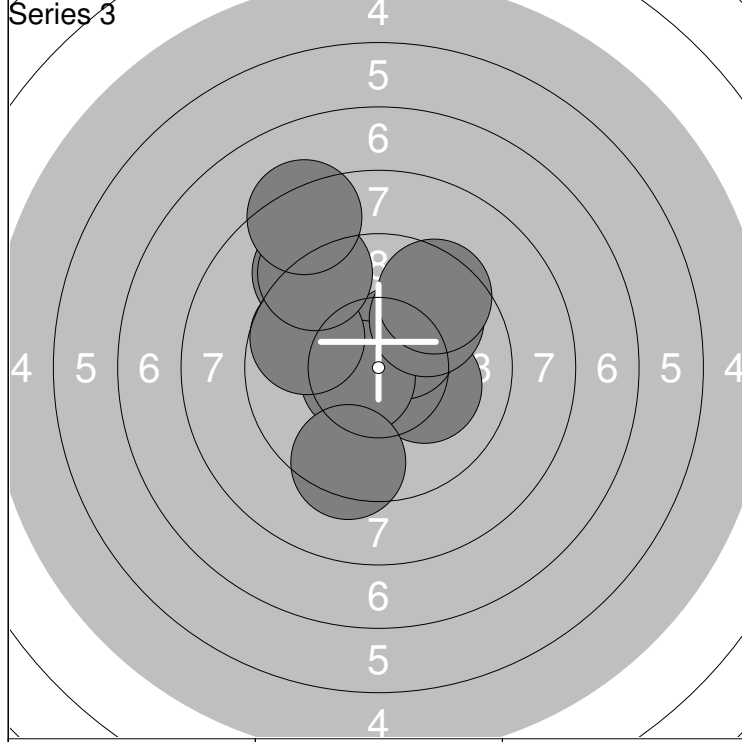

21: 9.1 ↗	26: 9.4 ↓	Series 92.0
22: 10.2x →	27: 9.2 ↗	
23: 10.4x ↗	28: 8.3 ↗	Total 284.0
24: 10.6x ←	29: 9.9 ↗	
25: 9.7 ↖	30: 9.5 ↗	

31: 10.3x ↑	36: 10.0 ↗	Series 93.0
32: 9.5 ↖	37: 10.8x ↓	
33: 9.2 ↖	38: 10.2x ↑	Total 377.0
34: 9.4 ↗	39: 9.2 ←	
35: 8.6 ↖	40: 9.9 ←	

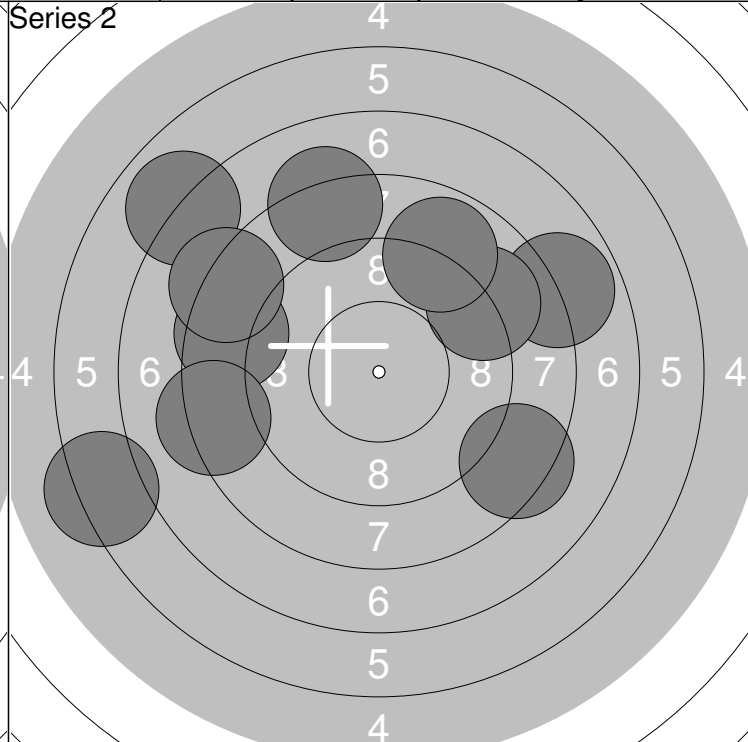
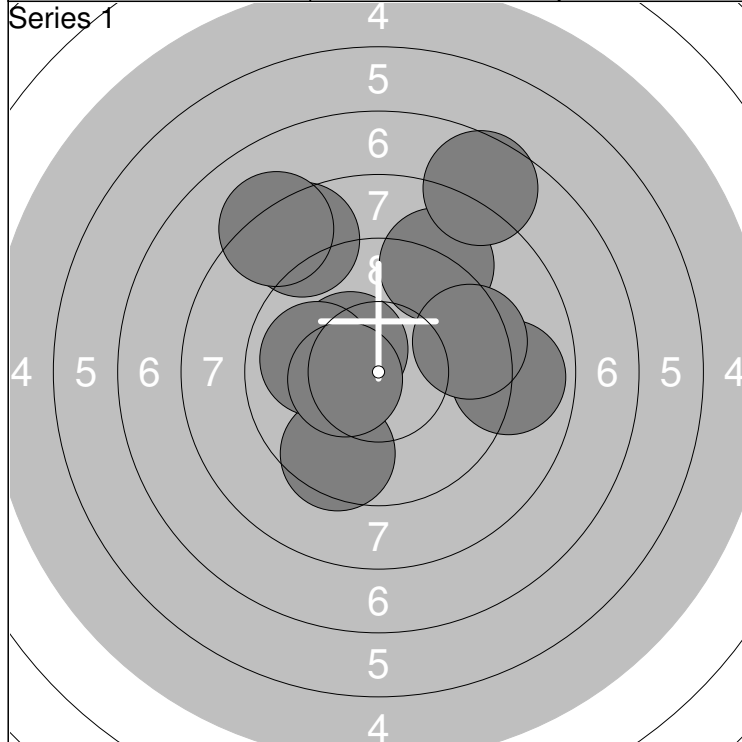

1: 8.9 →	6: 9.4 →	<b>Series</b> 88.0
2: 10.4x ↖	7: 8.5 ↗	
3: 9.5 ↓	8: 8.2 ↗	<b>Total</b> 88.0
4: 9.0 ↗	9: 10.4x ←	
5: 10.0 ←	10: 7.7 ↗	

11: 8.6 ←	16: 6.2 ←	<b>Series</b> 77.0
12: 7.9 →	17: 8.2 ↖	
13: 7.0 ↖	18: 8.2 ↗	<b>Total</b> 165.0
14: 9.0 ↗	19: 8.4 ↘	
15: 8.2 ←	20: 8.9 ↗	

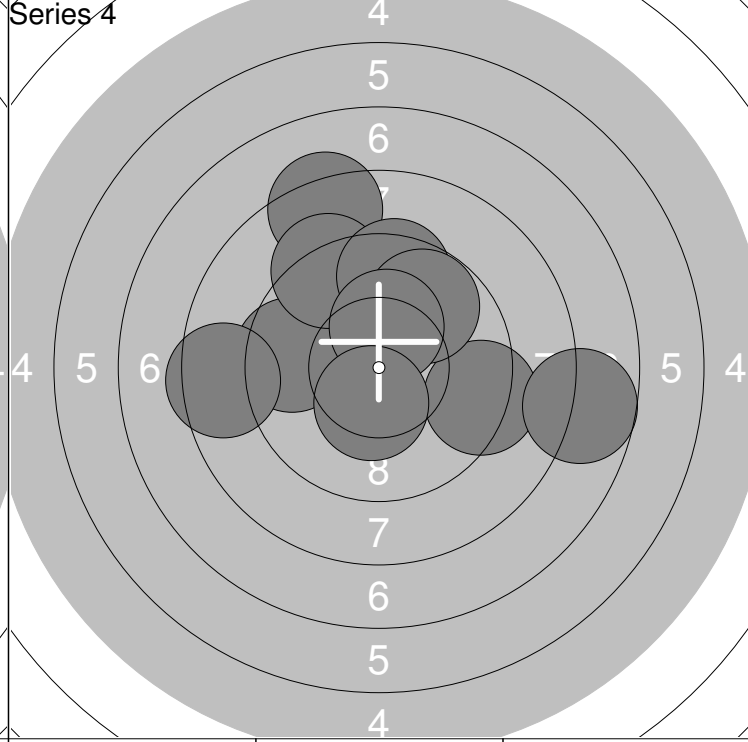
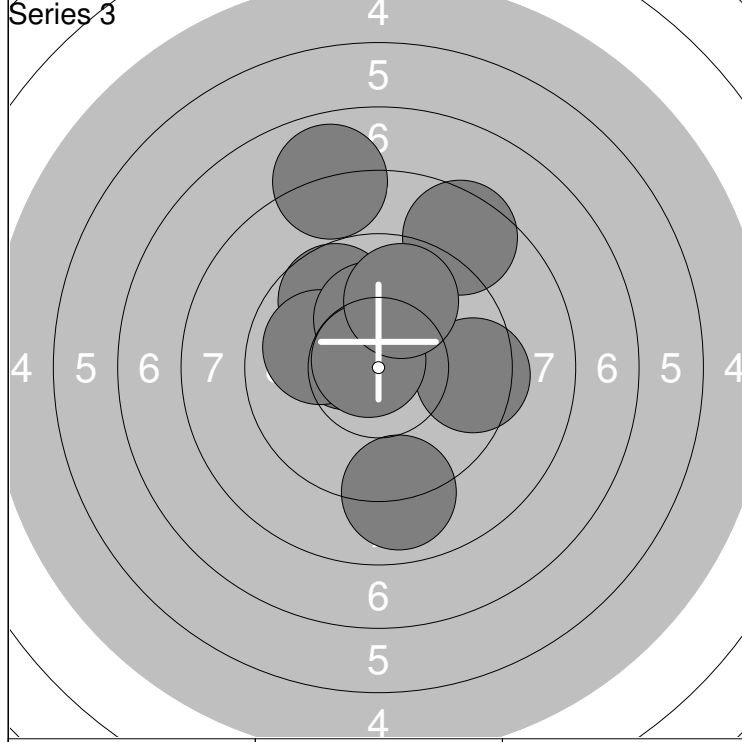

21: 7.9 ↗	26: 10.4x ↖	<b>Series</b> 91.0
22: 8.5 ↗	27: 10.0 ←	
23: 9.4 →	28: 10.2x ↗	<b>Total</b> 256.0
24: 9.7 ↖	29: 10.7x ↖	
25: 9.0 ↓	30: 9.8 ↗	

31: 9.6 ←	36: 7.7 →	<b>Series</b> 88.0
32: 8.4 ↗	37: 9.5 ↗	
33: 8.5 ←	38: 9.8 ↗	<b>Total</b> 344.0
34: 9.2 ↗	39: 10.3x ↗	
35: 9.3 →	40: 10.4x ↓	

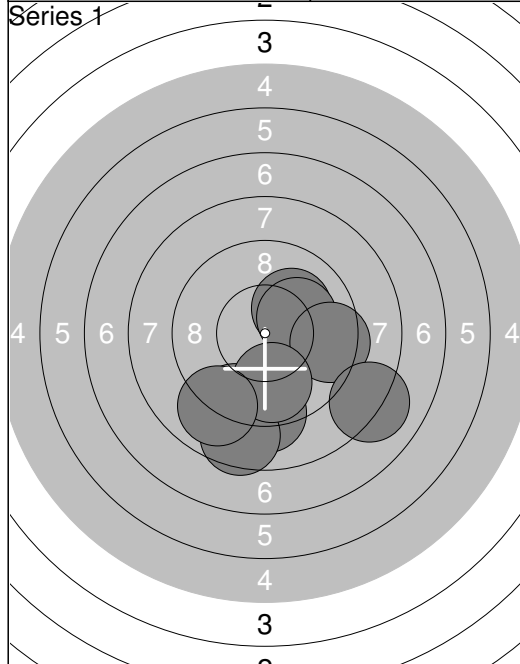

1:	10.1	↗
2:	10.1	↗
3:	9.5	→
4:	9.2	↓
5:	9.2	↓
6:	9.0	↓
7:	8.1	↘
8:	8.5	↓
9:	9.8	↓
10:	9.0	↙
<b>Series</b>		<b>90.0</b>
<b>Total</b>		<b>90.0</b>

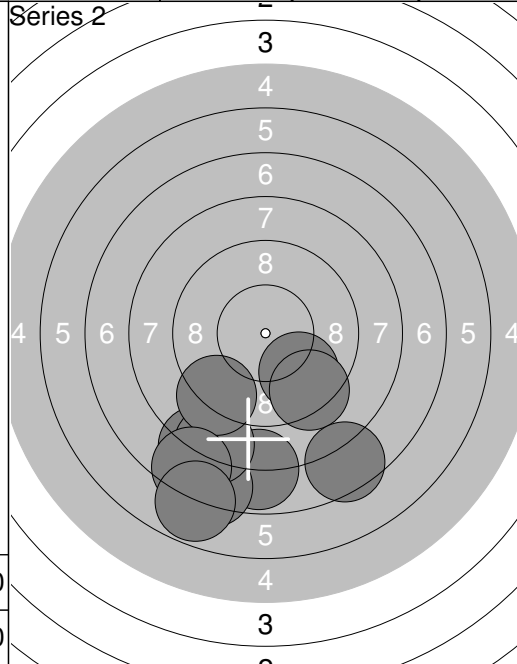

11:	9.8	↘
12:	9.3	↘
13:	7.9	↓
14:	7.3	↓
15:	8.0	↙
16:	8.2	↙
17:	9.2	↙
18:	7.5	↙
19:	7.5	↘
20:	6.8	↘
<b>Series</b>		<b>77.0</b>
<b>Total</b>		<b>167.0</b>

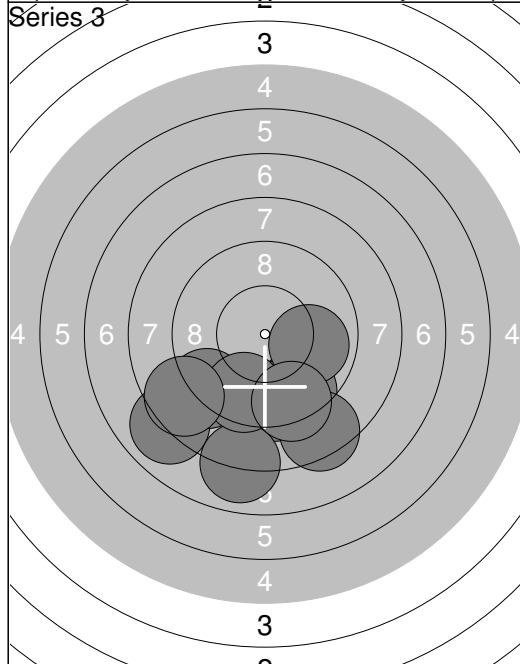

21:	9.5	↘
22:	9.4	↘
23:	9.9	→
24:	8.0	↙
25:	8.4	↘
26:	8.0	↓
27:	9.1	↙
28:	9.6	↓
29:	9.3	↘
30:	8.6	↙
<b>Series</b>		<b>86.0</b>
<b>Total</b>		<b>253.0</b>

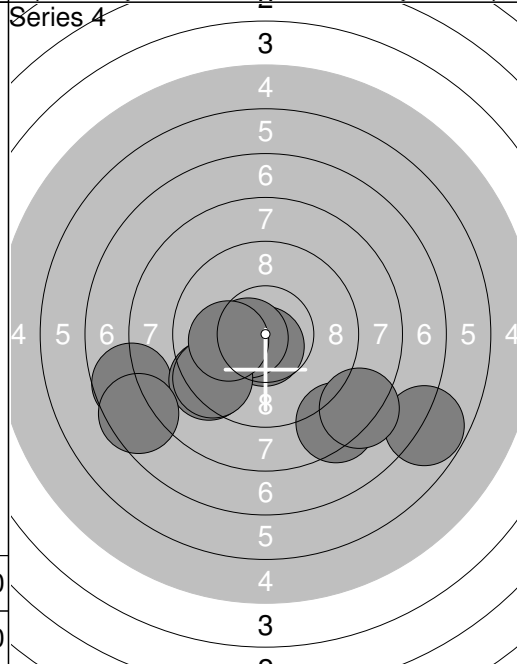

31:	6.8	↘
32:	7.7	↙
33:	8.4	↘
34:	10.7x	↓
35:	9.3	↙
36:	10.5x	↙
37:	9.4	↙
38:	10.1	↙
39:	8.2	↘
40:	7.6	↙
<b>Series</b>		<b>84.0</b>
<b>Total</b>		<b>337.0</b>

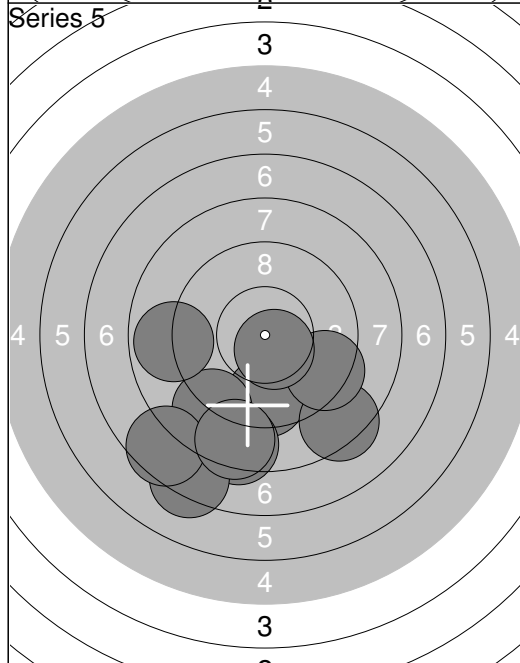

41:	9.5	↓
42:	8.4	↓
43:	7.3	↓
44:	8.4	↘
45:	8.9	↙
46:	7.6	↙
47:	8.8	↙
48:	8.5	↓
49:	9.4	↘
50:	10.6x	↘
<b>Series</b>		<b>82.0</b>
<b>Total</b>		<b>419.0</b>

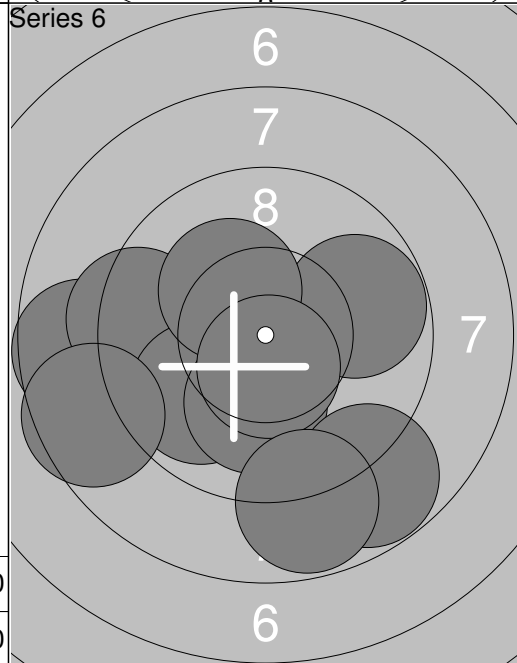

51:	8.7	↙
52:	9.3	↙
53:	9.9	↙
54:	10.1	↓
55:	9.8	→
56:	10.3x	↗
57:	8.8	↘
58:	10.5x	↓
59:	8.6	↙
60:	8.8	↓
<b>Series</b>		<b>89.0</b>
<b>Total</b>		<b>508.0</b>

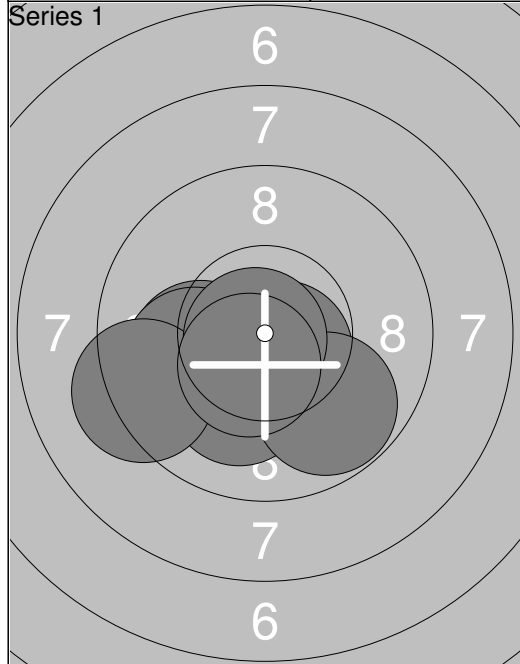

1:	10.2x ↘
2:	10.1 ←
3:	10.6x ↘
4:	10.4x ↓
5:	10.0 ←
6:	10.1 ↓
7:	9.8 ↘
8:	9.3 ←
9:	10.8x ↙
10:	10.5x ↘
<b>Series</b>	<b>98.0</b>
<b>Total</b>	<b>98.0</b>

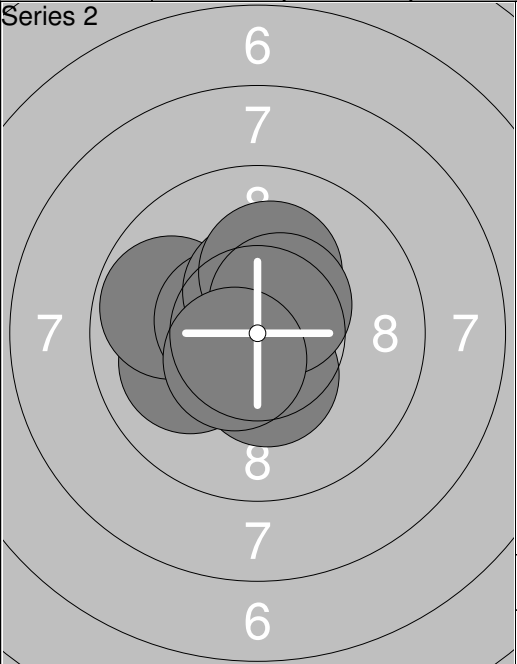

11:	10.0 ↙
12:	10.6x ↗
13:	9.8 ←
14:	10.5x ↖
15:	10.7x ↓
16:	10.4x ↓
17:	10.4x ↑
18:	10.2x ↑
19:	10.5x ↗
20:	10.5x ↘
<b>Series</b>	<b>99.0</b>
<b>Total</b>	<b>197.0</b>

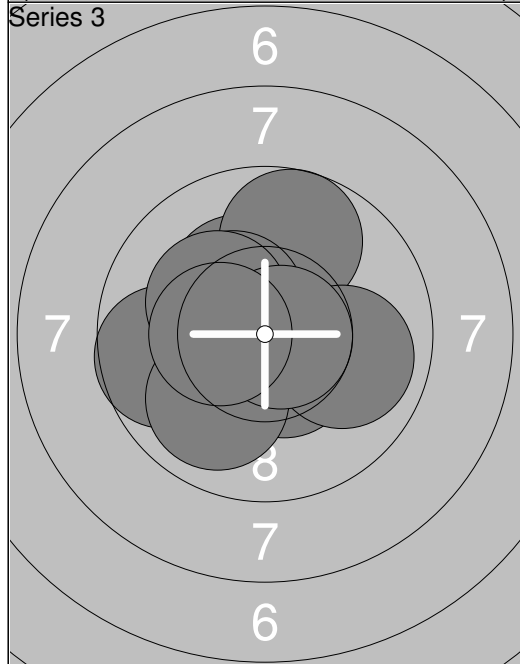

21:	10.3x ↗
22:	10.5x ↘
23:	9.8 ↑
24:	9.7 ←
25:	10.4x ↗
26:	9.9 →
27:	10.0 ↓
28:	10.2x ↖
29:	10.7x →
30:	10.4x ←
<b>Series</b>	<b>97.0</b>
<b>Total</b>	<b>294.0</b>

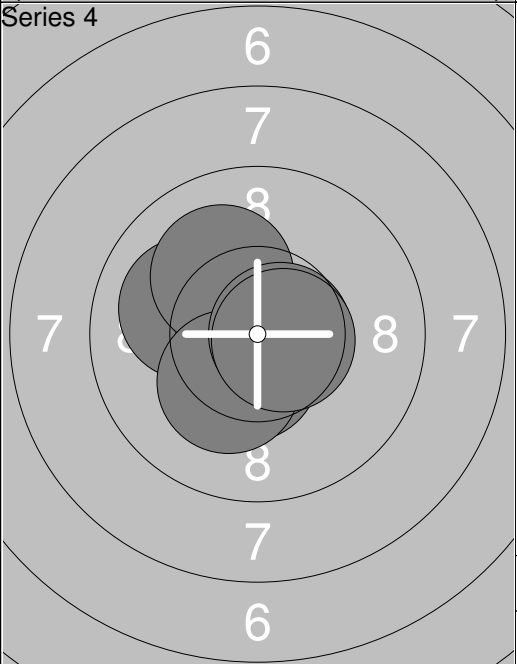

31:	10.7x ↙
32:	10.4x ↖
33:	10.4x ↓
34:	10.5x ↓
35:	10.1 ←
36:	10.8x ↖
37:	10.1 ↗
38:	10.3x ↘
39:	10.7x →
40:	10.6x →
<b>Series</b>	<b>100.0</b>
<b>Total</b>	<b>394.0</b>

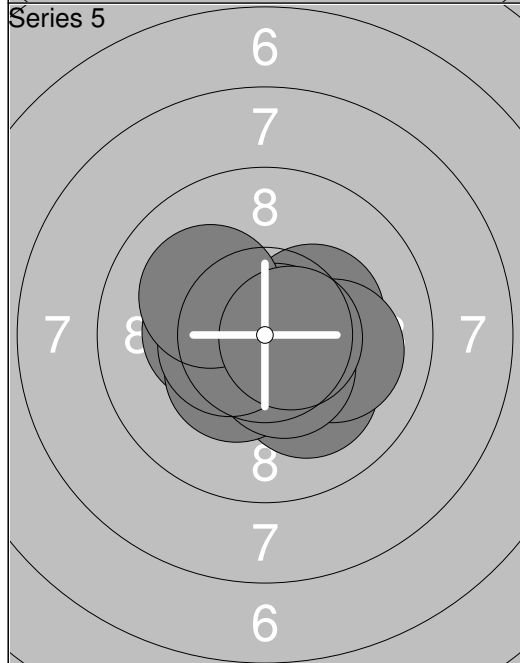

41:	10.3x →
42:	10.8x →
43:	10.1 ↓
44:	10.3x ←
45:	10.4x ↘
46:	10.1 →
47:	10.5x ↓
48:	10.5x ←
49:	10.1 ↖
50:	10.6x →
<b>Series</b>	<b>100.0</b>
<b>Total</b>	<b>494.0</b>

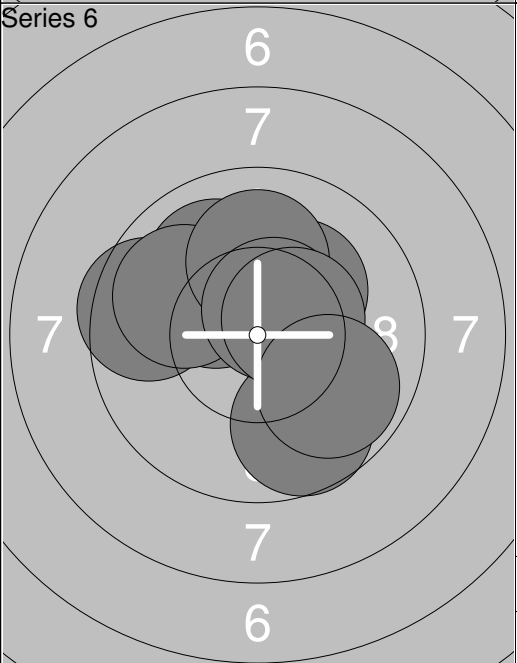

51:	10.2x ↖
52:	9.5 ←
53:	10.0 ↖
54:	9.9 ↖
55:	10.2x ↗
56:	10.0 ↑
57:	9.7 ↓
58:	10.6x ↗
59:	10.5x →
60:	9.9 ↘
<b>Series</b>	<b>96.0</b>
<b>Total</b>	<b>590.0</b>

Relay	Lane	Juho Ovaska		
4	20	TSA		AR R3Y16
8.-9.2.2014		Aluemestaruuskilpailut		Kankaanpään Ampumaurheilijat
<b>Series 1</b> 	1:	8.9	←	
	2:	10.5x	←	
	3:	10.0	↑	
	4:	10.2x	↙	
	5:	8.3	↗	
	6:	9.2	←	
	7:	9.5	↙	
	8:	9.6	↗	
	9:	10.2x	↑	
	10:	9.9	↗	
	<b>Series</b>			<b>92.0</b>
<b>Total</b>			<b>92.0</b>	
<b>Series 2</b> 	11:	9.2	←	
	12:	9.6	↑	
	13:	10.3x	→	
	14:	10.7x	↗	
	15:	9.7	↙	
	16:	9.5	↑	
	17:	10.5x	←	
	18:	10.4x	↗	
	19:	10.0	↑	
	20:	9.3	↗	
	<b>Series</b>			<b>95.0</b>
<b>Total</b>			<b>187.0</b>	
<b>Series 3</b> 	21:	9.1	↗	
	22:	10.1	↑	
	23:	9.7	↑	
	24:	9.7	↗	
	25:	10.0	←	
	26:	10.2x	↗	
	27:	9.8	↙	
	28:	8.9	→	
	29:	9.4	↙	
	30:	10.6x	↑	
	<b>Series</b>			<b>93.0</b>
<b>Total</b>			<b>280.0</b>	