

1: 9.7 ←
2: 10.7x ↑
3: 10.6x ↘
4: 10.2x ↑
5: 9.3 →
6: 9.5 ←
7: 10.6x ↘
8: 10.5x →
9: 10.1 ←
10: 9.6 ↖
Series 100.8
Total 100.8

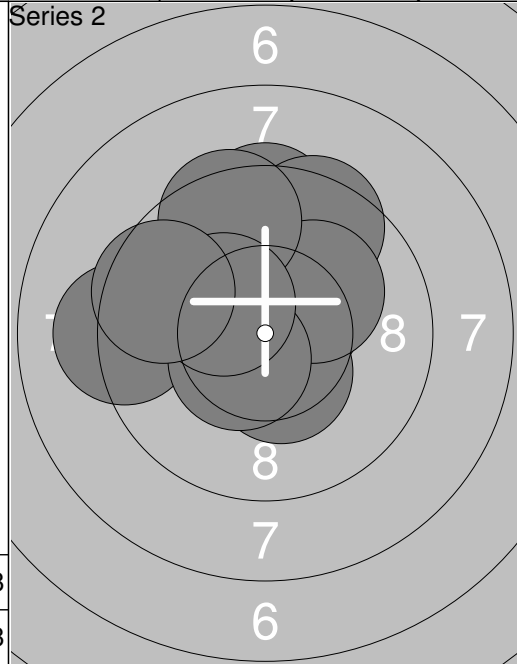

11: 10.5x ↗
12: 10.4x ↓
13: 9.5 ↑
14: 9.5 ↗
15: 10.1 ↗
16: 9.2 ←
17: 10.5x ↘
18: 9.5 ↑
19: 10.3x ↘
20: 9.6 ←
Series 99.1
Total 199.9

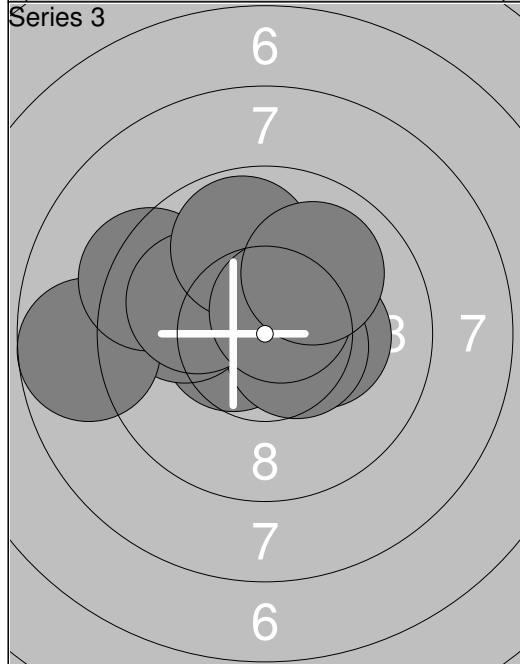

21: 10.5x ←
22: 9.9 ←
23: 10.3x →
24: 8.8 ←
25: 10.5x →
26: 9.4 ↖
27: 10.0 ↖
28: 9.8 ↑
29: 10.6x ↗
30: 10.0 ↗
Series 99.8
Total 299.7

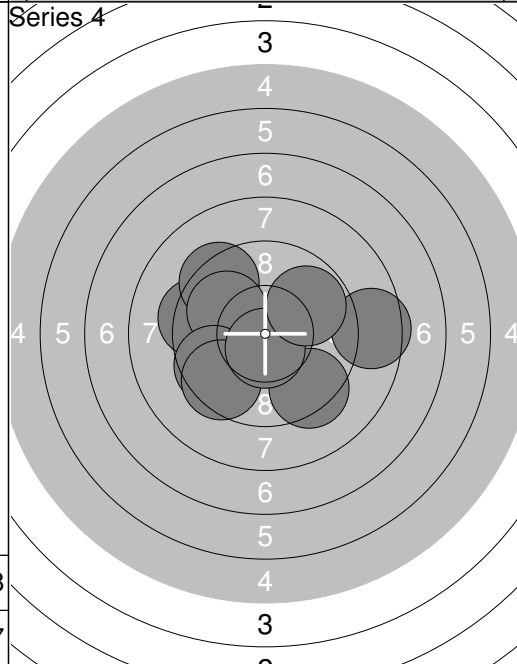

31: 10.0 ←
32: 9.4 ←
33: 9.4 ↗
34: 9.4 ↘
35: 9.9 ↗
36: 9.6 ↖
37: 9.5 ↘
38: 10.6x ↓
39: 8.6 →
40: 9.8 ↗
Series 96.2
Total 395.9

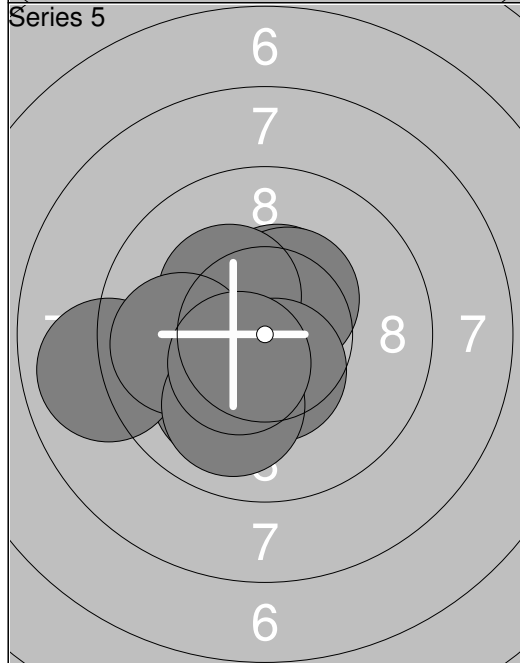

41: 9.9 ←
42: 10.4x ↑
43: 10.0 ↘
44: 10.4x ↗
45: 10.3x ↖
46: 10.5x ↓
47: 8.9 ←
48: 9.9 ←
49: 10.0 ↓
50: 10.5x ↘
Series 100.8
Total 496.7

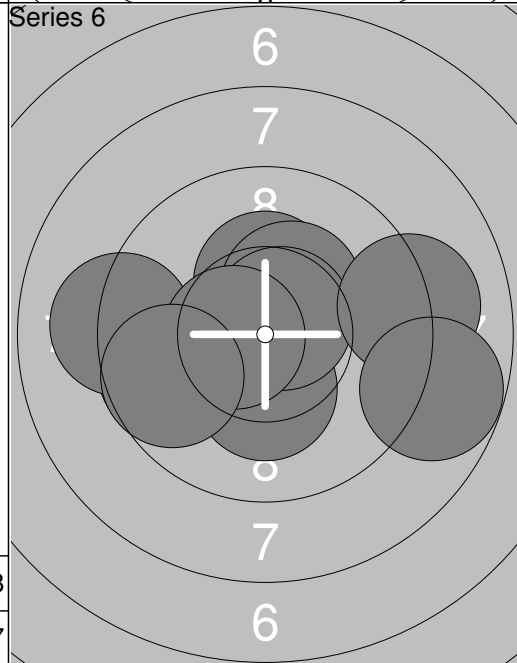

51: 9.7 ←
52: 10.3x ↓
53: 9.1 ←
54: 10.3x ↑
55: 10.3x ↗
56: 10.7x ↗
57: 9.1 →
58: 10.6x ←
59: 8.8 →
60: 9.7 ←
Series 98.6
Total 595.3

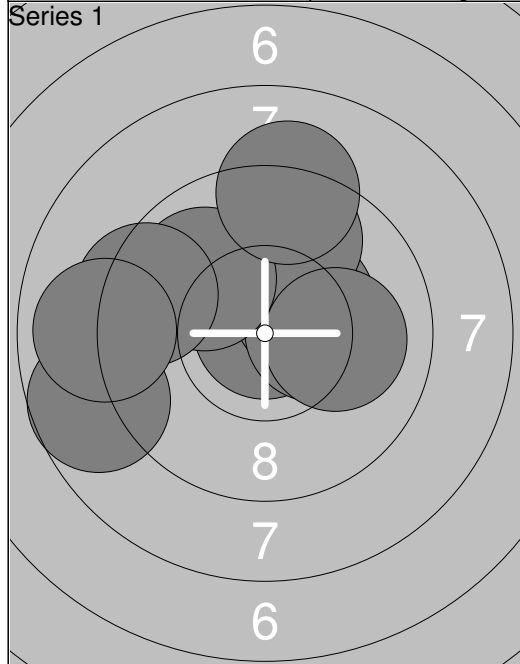

1:	10.9x	↑
2:	10.4x	↗
3:	10.3x	→
4:	8.7	←
5:	9.7	↑
6:	9.9	↖
7:	9.4	←
8:	10.1	→
9:	8.9	←
10:	9.2	↑
Series		97.5
Total		97.5

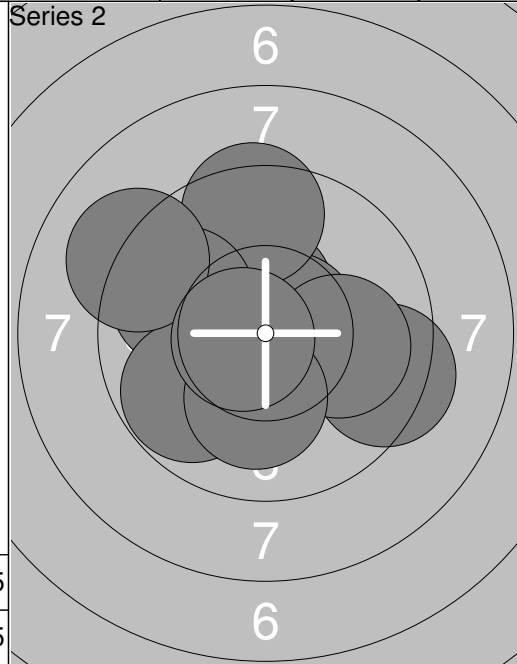

11:	10.5x	↑
12:	10.6x	↗
13:	9.5	↑
14:	9.8	↖
15:	9.4	→
16:	10.0	→
17:	9.8	↙
18:	9.1	↖
19:	10.1	↓
20:	10.7x	↙
Series		99.5
Total		197.0

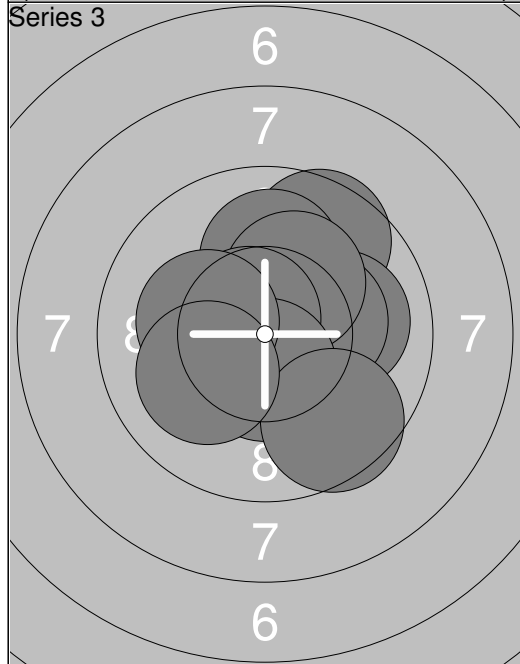

21:	9.6	↗
22:	10.0	→
23:	10.3x	→
24:	10.0	↑
25:	10.2x	↗
26:	10.7x	↖
27:	10.5x	↓
28:	9.6	↘
29:	10.2x	↙
30:	10.1	↙
Series		101.2
Total		298.2

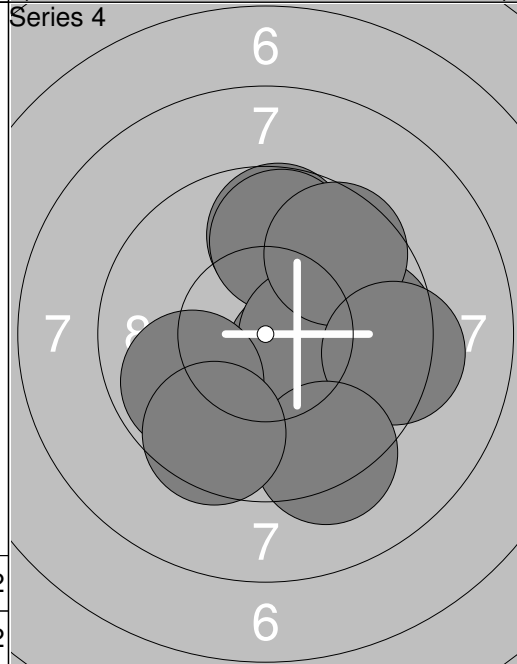

31:	9.7	↑
32:	10.5x	↘
33:	9.7	→
34:	9.8	↑
35:	10.4x	→
36:	9.6	↗
37:	9.3	→
38:	9.3	↓
39:	9.8	↙
40:	9.5	↘
Series		97.6
Total		395.8

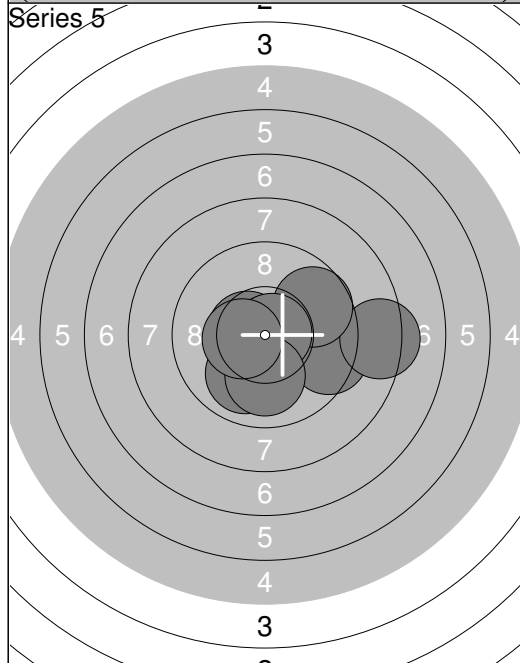

41:	10.0	→
42:	10.5x	↙
43:	10.0	↘
44:	9.4	→
45:	8.4	→
46:	9.7	↗
47:	10.9x	→
48:	10.8x	→
49:	10.0	↓
50:	10.4x	↙
Series		100.1
Total		495.9

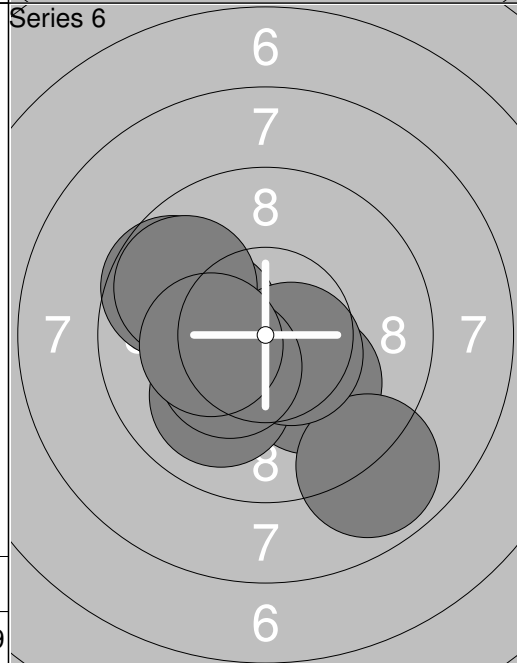

51:	10.2x	↙
52:	9.6	↖
53:	10.5x	↘
54:	9.8	↖
55:	10.1	↘
56:	10.0	↙
57:	8.8	↘
58:	10.5x	↘
59:	10.4x	↙
60:	10.2x	↙
Series		100.1
Total		596.0

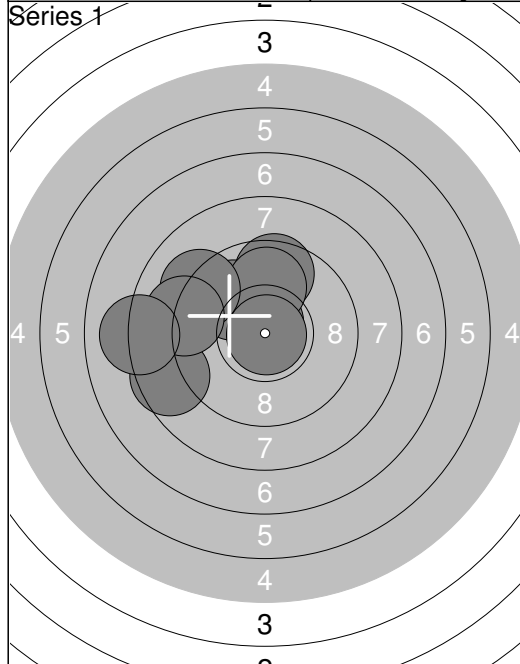

1:	10.4x ↗
2:	10.7x ↗
3:	9.9 ↖
4:	9.6 ↗
5:	9.9 ↗
6:	9.2 ↖
7:	10.9x ↘
8:	8.6 ←
9:	9.1 ←
10:	8.1 ←
Series	96.4
Total	96.4

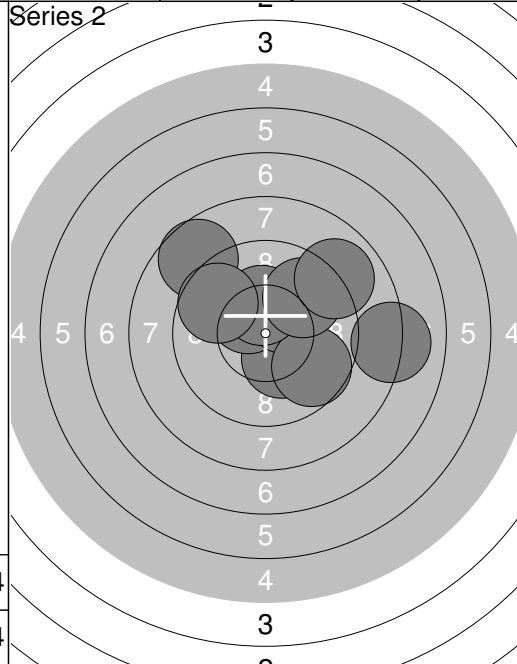

11:	10.3x ↘
12:	10.4x ↖
13:	8.1 →
14:	10.3x ↗
15:	9.7 ↘
16:	10.3x ↗
17:	9.8 ↗
18:	8.9 ↗
19:	8.7 ↖
20:	9.7 ↖
Series	96.2
Total	192.6

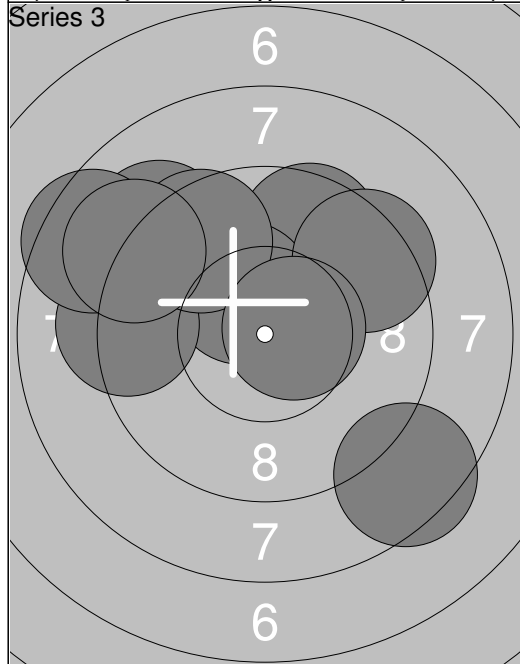

21:	9.6 ↗
22:	8.4 ↘
23:	10.4x ↗
24:	9.2 ←
25:	9.1 ↗
26:	8.5 ↖
27:	9.5 ↗
28:	9.4 ↗
29:	10.6x →
30:	9.0 ↖
Series	93.7
Total	286.3

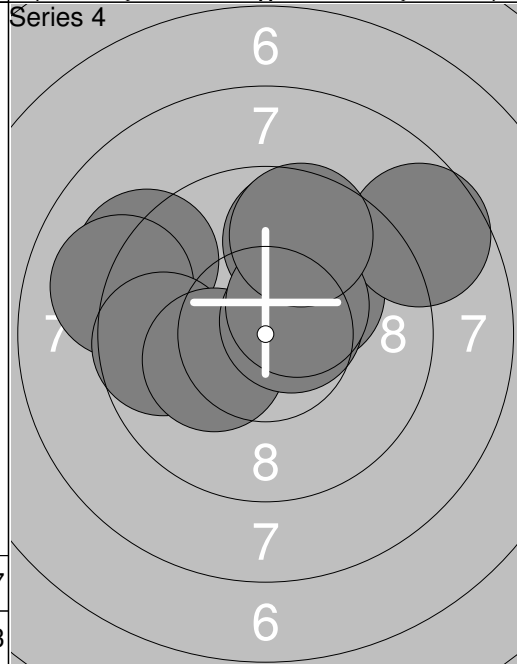

31:	9.2 ↖
32:	9.1 ←
33:	9.7 ←
34:	10.2x ↙
35:	10.2x ↗
36:	8.7 ↗
37:	9.8 ↗
38:	10.6x ↗
39:	10.4x ↗
40:	9.6 ↗
Series	97.5
Total	383.8

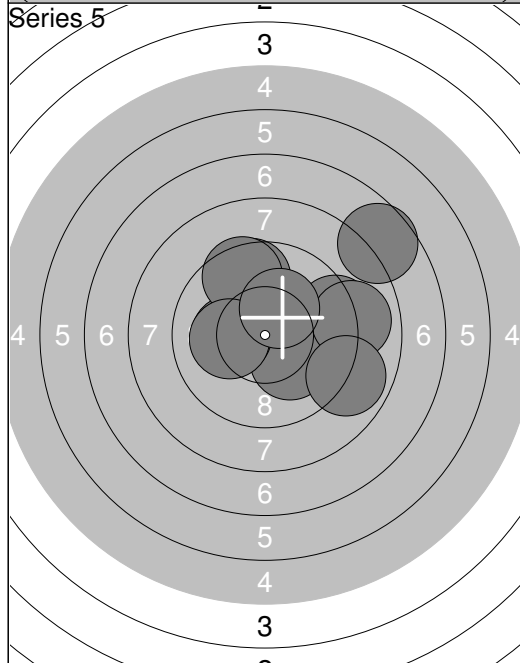

41:	9.3 →
42:	10.1 ↘
43:	10.2x ←
44:	9.0 →
45:	9.6 ↗
46:	8.9 ↘
47:	9.5 ↗
48:	10.2x ←
49:	7.6 ↗
50:	10.3x ↗
Series	94.7
Total	478.5

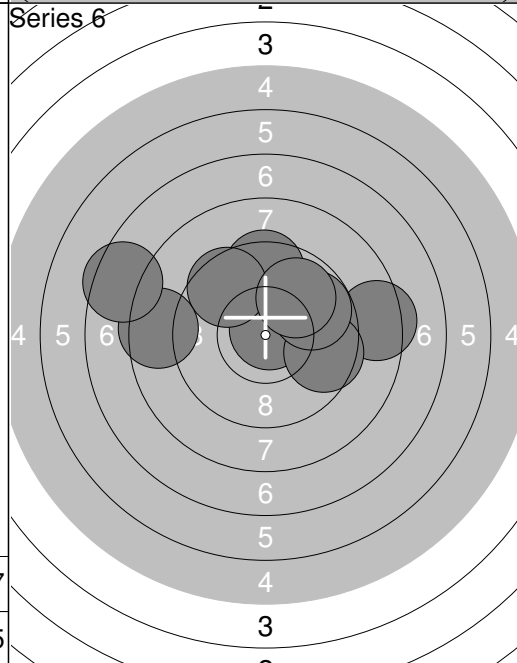

51:	9.9 ↗
52:	8.4 →
53:	10.8x ↗
54:	9.5 ↗
55:	9.6 ↖
56:	9.6 →
57:	8.5 ←
58:	9.7 ↗
59:	7.5 ←
60:	9.9 ↗
Series	93.4
Total	571.9

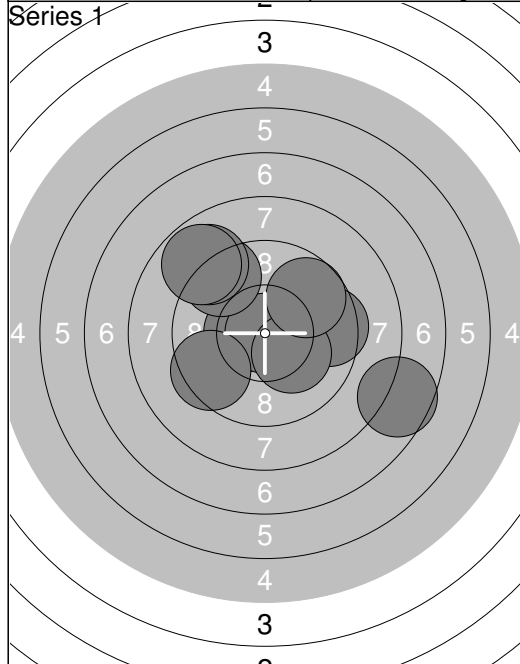

1: 10.5x	←
2: 10.9x	
3: 9.3	↗
4: 8.9	↗
5: 9.5	→
6: 10.2x	↘
7: 9.5	↙
8: 8.8	↖
9: 9.7	↗
10: 7.6	↘
Series	94.9
Total	94.9

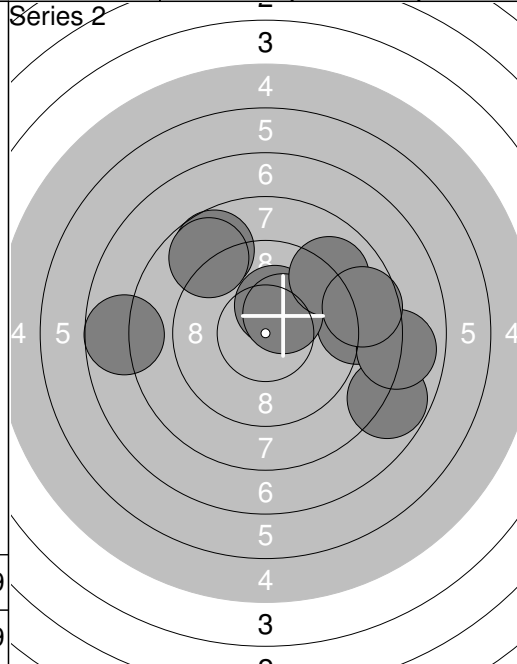

11: 7.7	←
12: 10.3x	↗
13: 8.7	↖
14: 8.8	→
15: 10.4x	↗
16: 7.8	↘
17: 8.0	→
18: 9.0	↗
19: 8.7	→
20: 8.8	↖
Series	88.2
Total	183.1

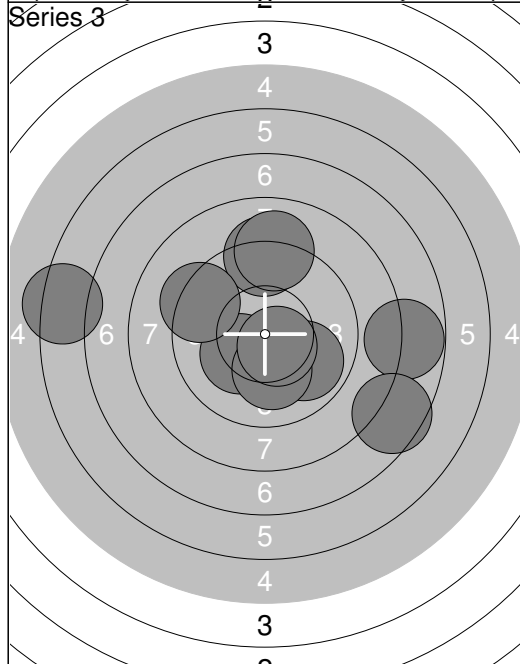

21: 6.3	←
22: 9.2	↑
23: 9.1	↑
24: 10.2x	↙
25: 9.9	↘
26: 7.8	→
27: 10.1	↓
28: 10.6x	↘
29: 9.3	↖
30: 7.6	↘
Series	90.1
Total	273.2

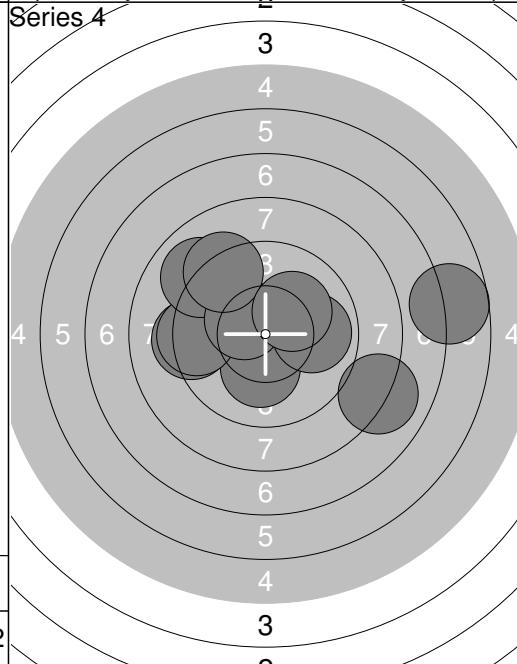

31: 10.2x	↘
32: 9.3	←
33: 9.4	←
34: 9.9	→
35: 9.0	↖
36: 10.4x	↖
37: 9.2	↖
38: 6.7	→
39: 8.1	↘
40: 10.1	↗
Series	92.3
Total	365.5

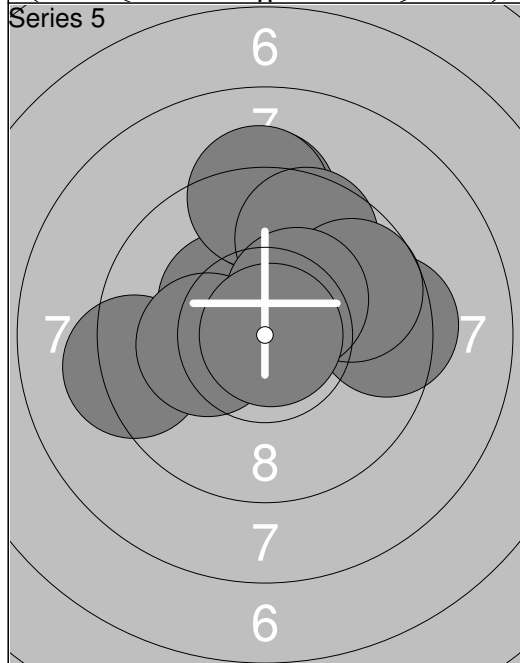

41: 10.3x	↖
42: 9.3	↑
43: 9.2	↑
44: 9.6	↗
45: 9.3	←
46: 9.4	→
47: 10.2x	←
48: 9.7	↗
49: 10.3x	↗
50: 10.9x	→
Series	98.2
Total	463.7

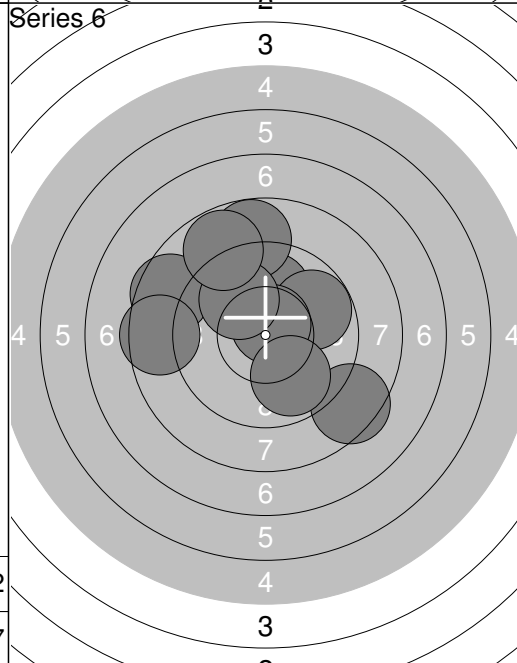

51: 10.0	↑
52: 8.6	↖
53: 9.8	↗
54: 8.6	←
55: 8.8	↑
56: 10.7x	↗
57: 8.5	↘
58: 9.9	↘
59: 10.0	↖
60: 8.8	↖
Series	93.7
Total	557.4

Relay 1	Lane 5	Tiina Siirilä					
--------------------------	-------------------------	----------------------	--	--	--	--	--

Air	KhjA	AR N
------------	-------------	-------------

16.-17.11.2013	Tauno Kärjen muistokilpailu	Kankaanpään Ampumaurheilijat
-----------------------	------------------------------------	-------------------------------------

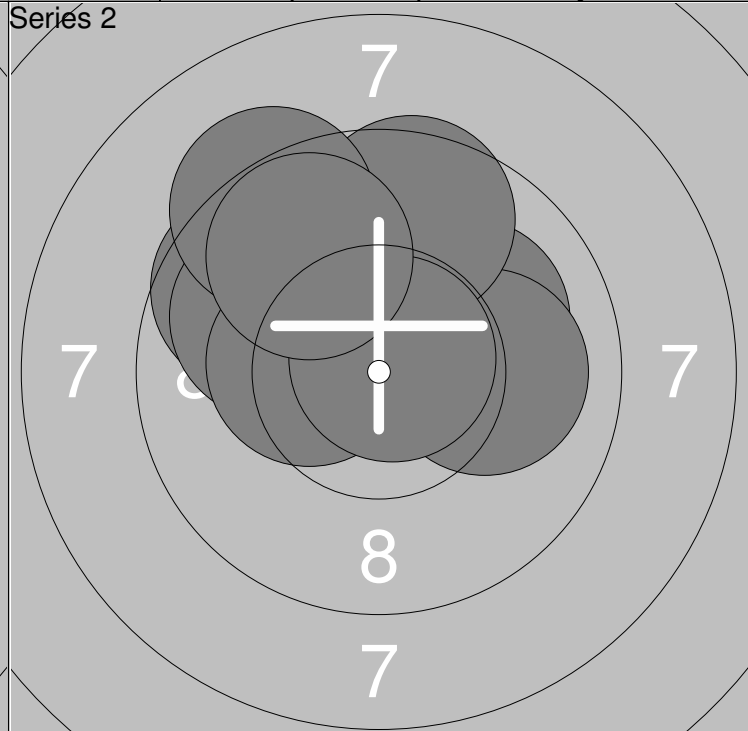
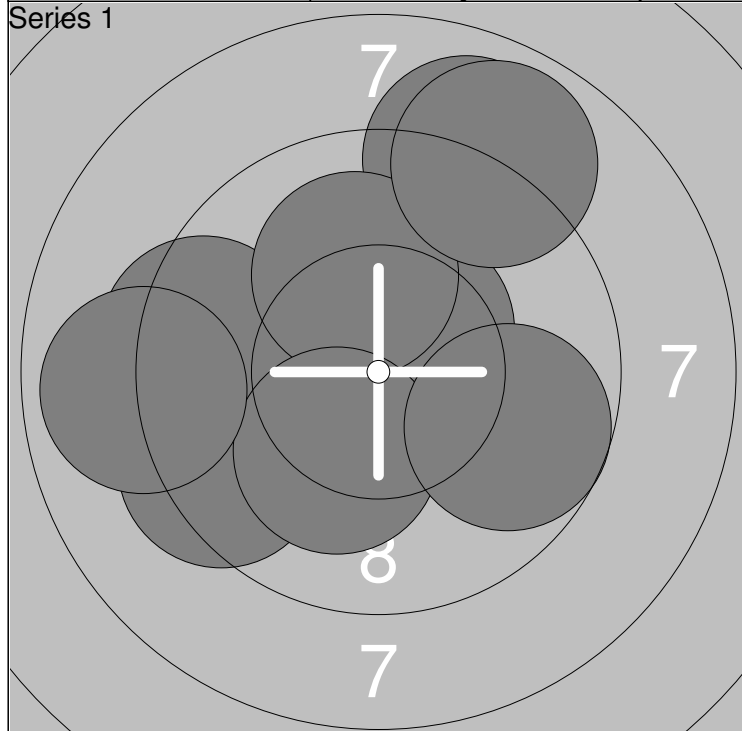

1: 8.9 ↗	6: 10.1 ↗	Series 95.7
2: 9.7 ↙	7: 10.2x ↘	
3: 9.4 ↙	8: 8.9 ←	Total 95.7
4: 9.4 ↙	9: 9.7 →	
5: 10.5x ↗	10: 8.9 ↗	

11: 9.7 ↖	16: 10.4x ←	Series 99.9
12: 10.2x ↑	17: 9.6 ↑	
13: 9.9 ↖	18: 9.3 ↗	Total 195.6
14: 10.1 ↗	19: 10.8x ↗	
15: 10.1 →	20: 9.8 ↖	

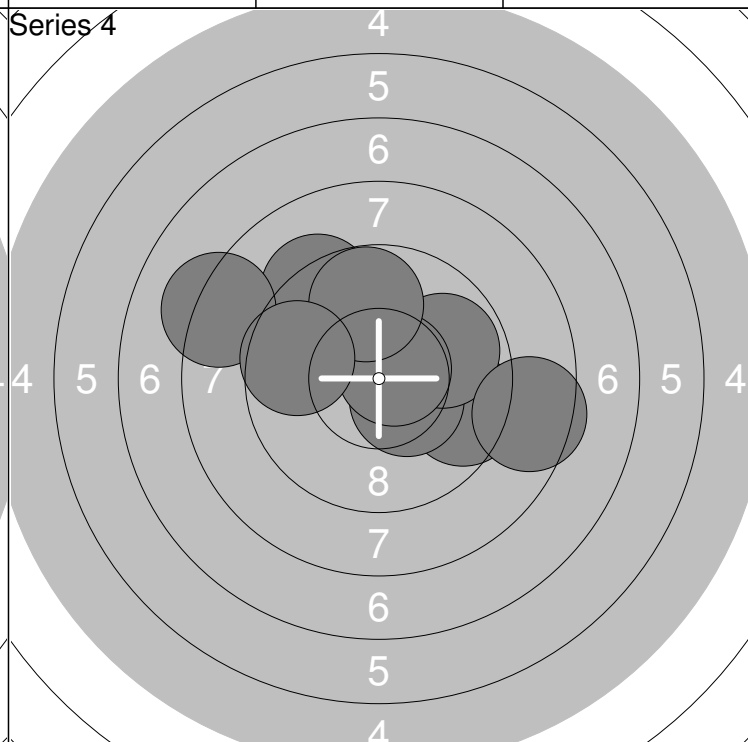
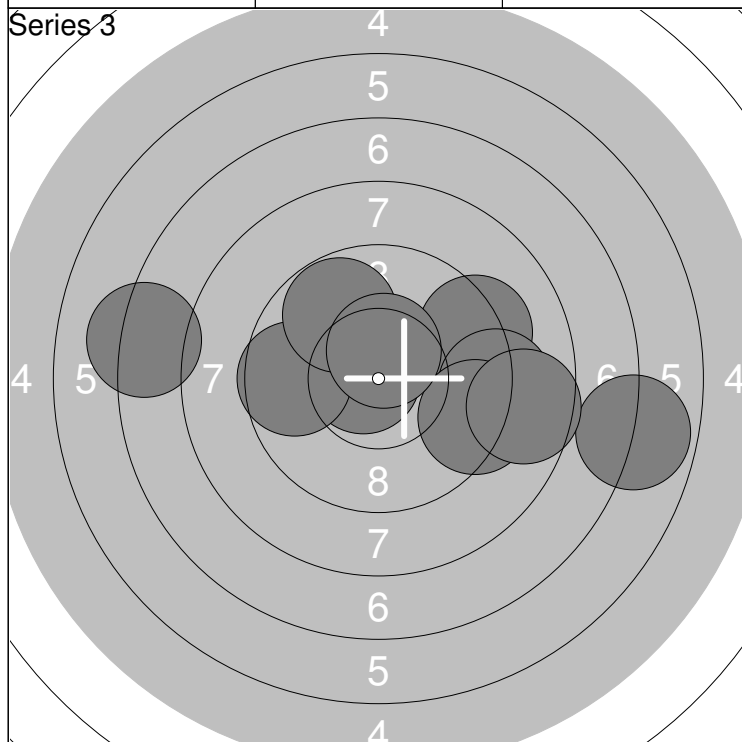

21: 9.3 ↗	26: 9.3 →	Series 91.0
22: 10.7x ←	27: 7.2 ←	
23: 6.9 →	28: 8.6 →	Total 286.6
24: 9.1 →	29: 9.8 ↗	
25: 9.6 ←	30: 10.5x ↗	

31: 10.2x ↑	36: 8.2 ↖	Series 96.0
32: 9.3 ↗	37: 8.5 →	
33: 9.5 →	38: 10.7x ↗	Total 382.6
34: 10.4x ↘	39: 9.8 ↑	
35: 9.8 ↗	40: 9.6 ←	

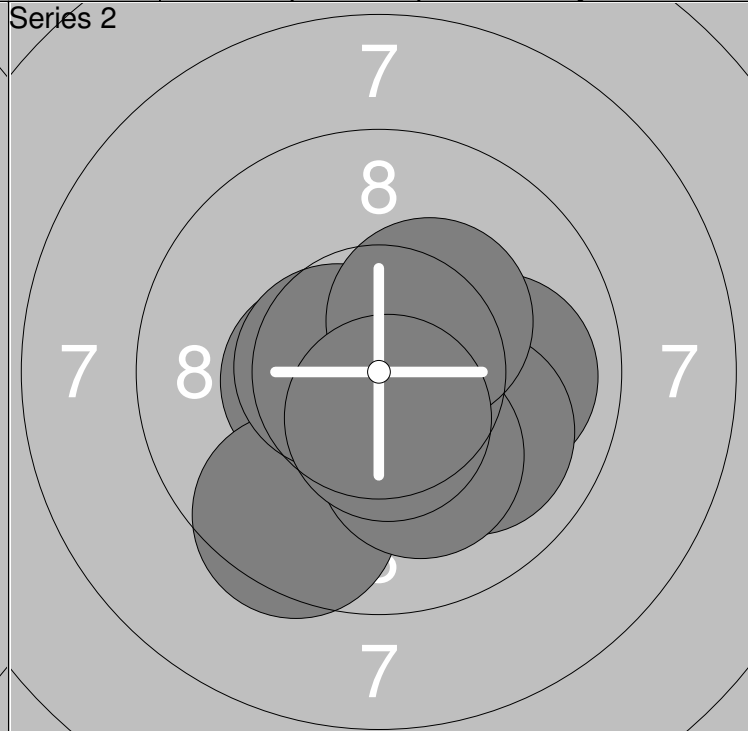
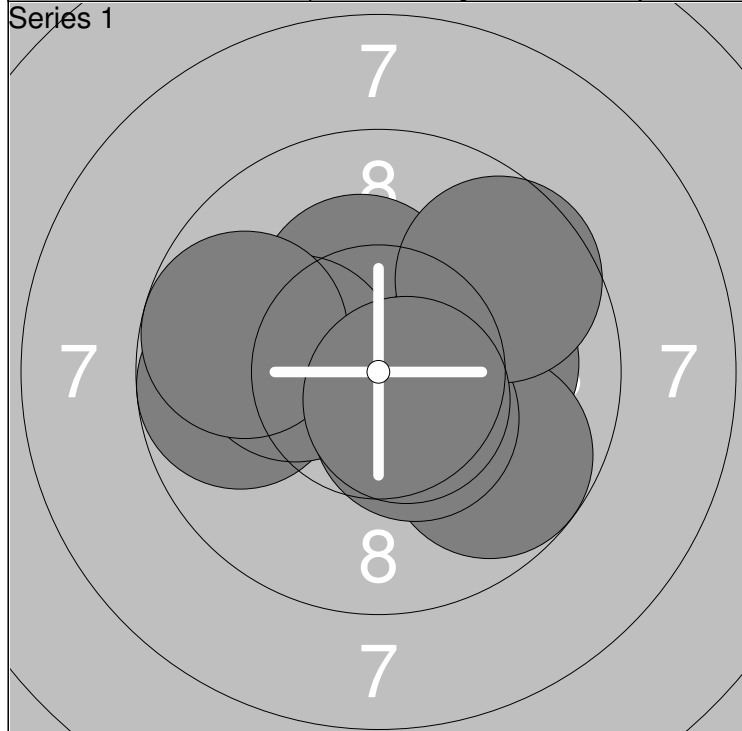

1: 10.5x ↑	6: 9.8 ←	Series 100.9
2: 9.7 ←	7: 9.7 ↓	
3: 10.3x ↑	8: 10.4x ↓	Total 100.9
4: 10.2x ←	9: 9.6 ↗	
5: 10.1 →	10: 10.6x ↓	

11: 10.4x ↓	16: 9.5 ↓	Series 102.3
12: 10.4x ↗	17: 10.6x ←	
13: 10.5x ←	18: 10.1 ↓	Total 203.2
14: 10.0 →	19: 10.3x ↗	
15: 10.0 ↓	20: 10.5x ↓	

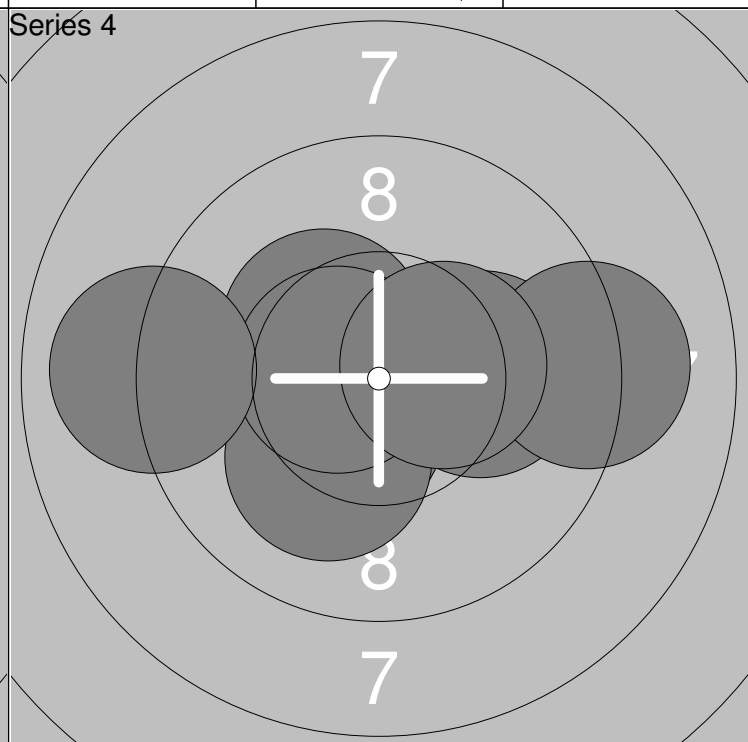
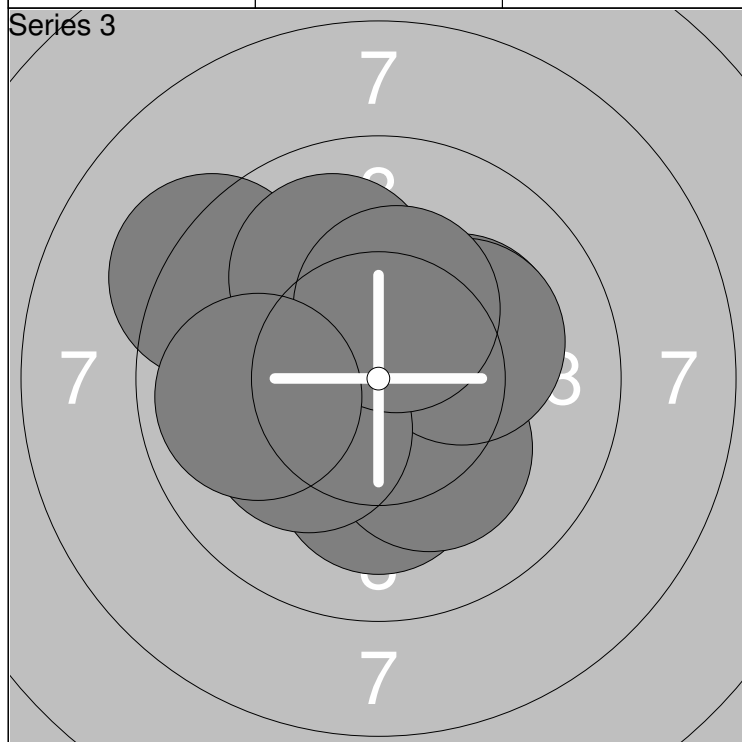

21: 9.3 ↖	26: 10.2x ↗	Series 101.1
22: 10.7x ↖	27: 10.2x ↓	
23: 10.2x ↗	28: 10.0 ↑	Total 304.3
24: 10.1 ↓	29: 10.3x ↑	
25: 10.2x ↓	30: 9.9 ←	

31: 10.1 →	36: 10.3x ↖	Series 100.9
32: 10.4x ↓	37: 9.1 →	
33: 10.6x ←	38: 10.6x ←	Total 405.2
34: 10.3x ←	39: 9.0 ←	
35: 10.1 ↓	40: 10.4x →	

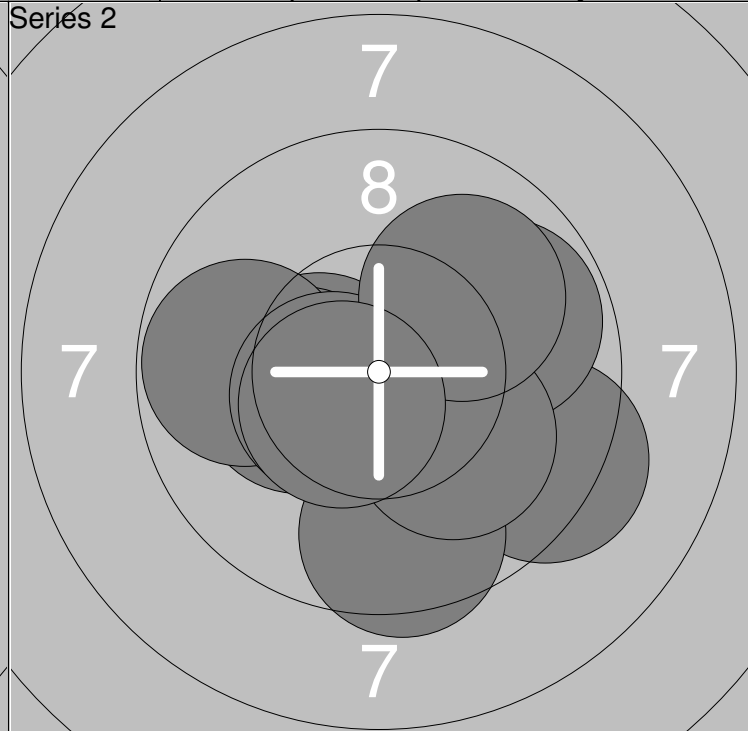
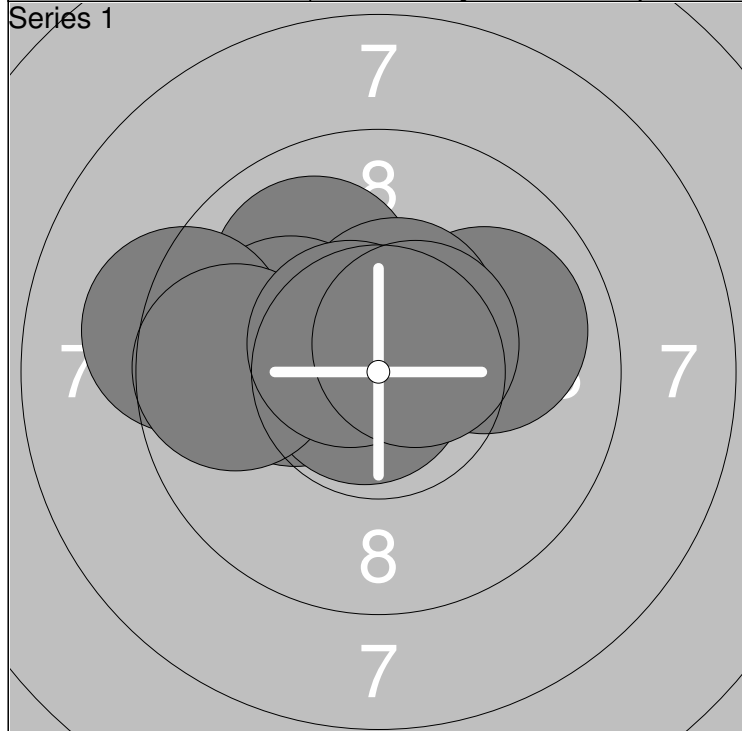

1: 10.2x ←	6: 10.5x ↗	Series 101.7
2: 10.0 ↗	7: 10.8x ↙	
3: 10.2x ←	8: 9.7 ←	Total 101.7
4: 9.2 ←	9: 10.6x ↖	
5: 10.0 →	10: 10.5x ↗	

11: 9.3 →	16: 9.5 ↓	Series 100.1
12: 10.4x ←	17: 10.1 ↘	
13: 10.2x ←	18: 10.5x ↙	Total 201.8
14: 9.8 ←	19: 10.0 ↗	
15: 9.8 →	20: 10.5x ↙	

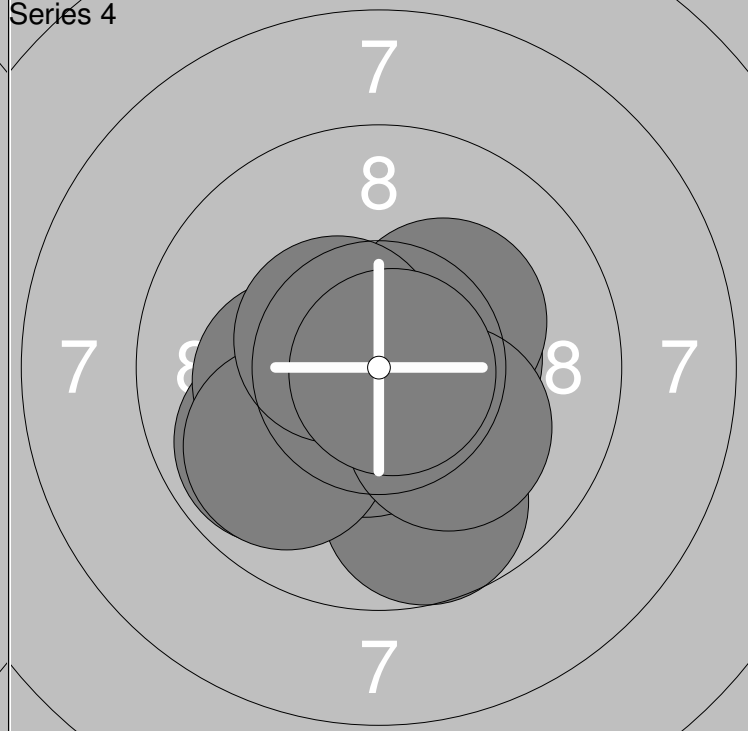
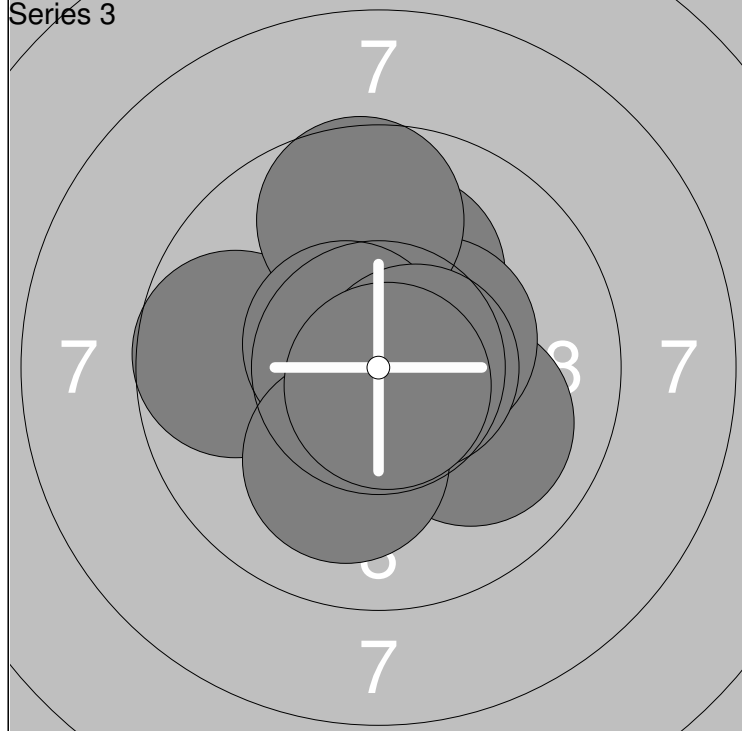

21: 10.1 ↗	26: 9.7 ↗	Series 102.8
22: 10.0 ↘	27: 10.6x ↖	
23: 10.8x ↗	28: 10.6x →	Total 304.6
24: 9.7 ←	29: 10.1 ↓	
25: 10.4x ↗	30: 10.8x ↓	

31: 10.4x →	36: 10.5x ↓	Series 102.4
32: 10.3x ↗	37: 9.9 ↙	
33: 9.9 ↙	38: 10.5x ↖	Total 407.0
34: 9.7 ↓	39: 10.2x ↘	
35: 10.2x ←	40: 10.8x →	

Relay	Lane	Marianne Palo	
1	8		

Air	IMAS	AR N
-----	------	------

16.-17.11.2013	Tauno Kärjen muistokilpailu	Kankaanpään Ampumaurheilijat
----------------	-----------------------------	------------------------------

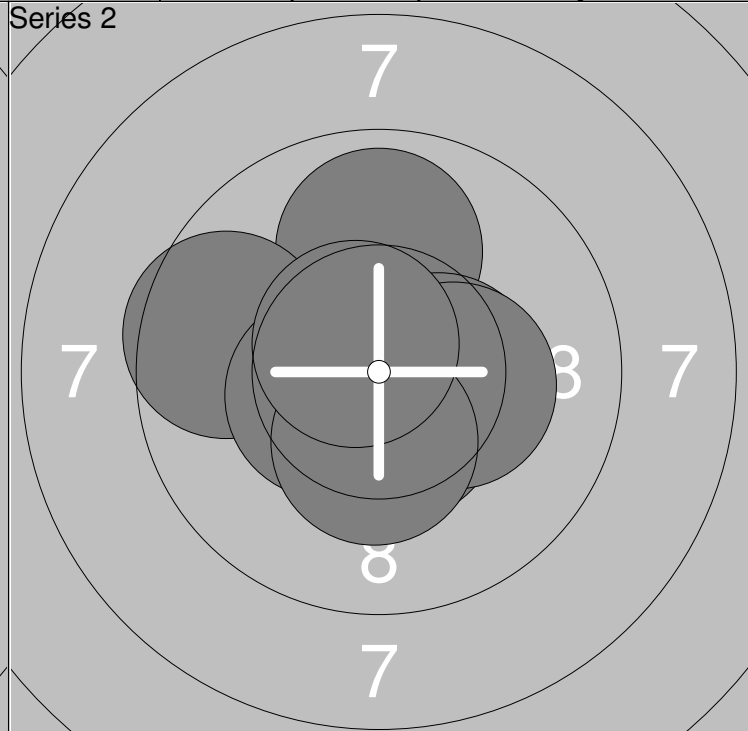
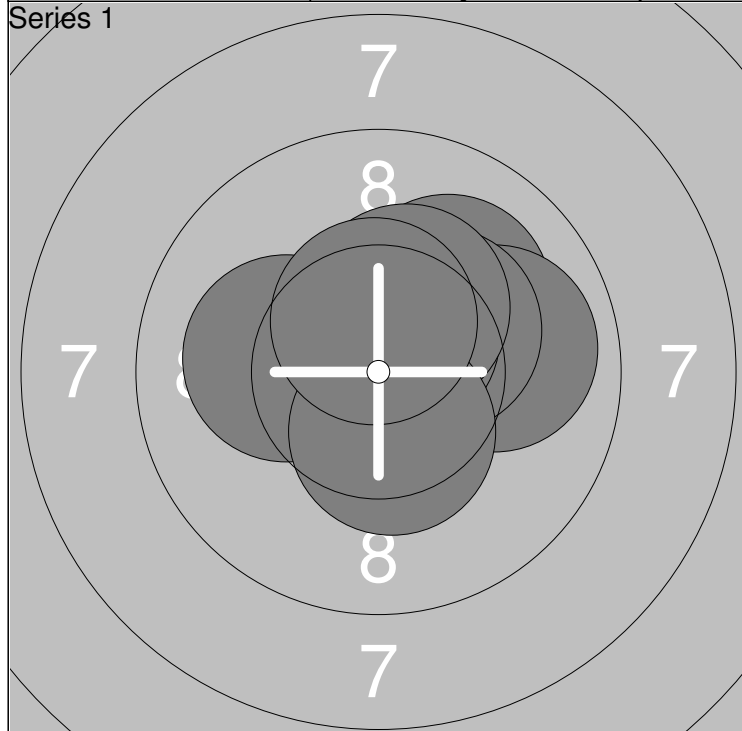

1: 10.1 ↗	6: 10.6x ↗	Series	103.4
2: 10.6x ↑	7: 10.6x ↑		
3: 10.1 ←	8: 10.3x ↗	Total	103.4
4: 9.9 →	9: 10.4x ↓		
5: 10.3x ↗	10: 10.5x ↑		

11: 9.9 ↑	16: 10.4x →	Series	103.3
12: 10.5x ↙	17: 10.5x ↙		
13: 10.7x ↘	18: 10.3x →	Total	206.7
14: 10.5x ↓	19: 10.3x ↓		
15: 9.6 ←	20: 10.6x ↙		

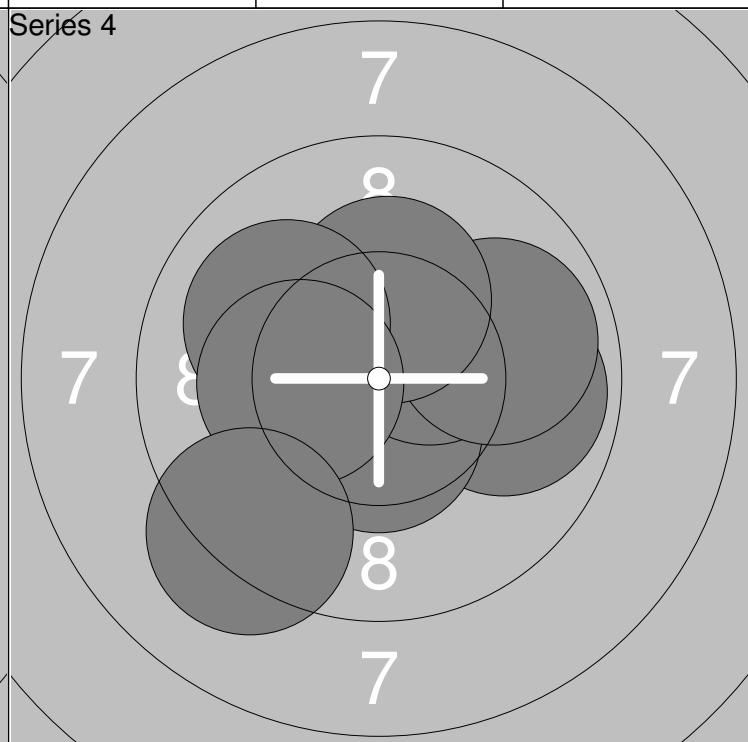
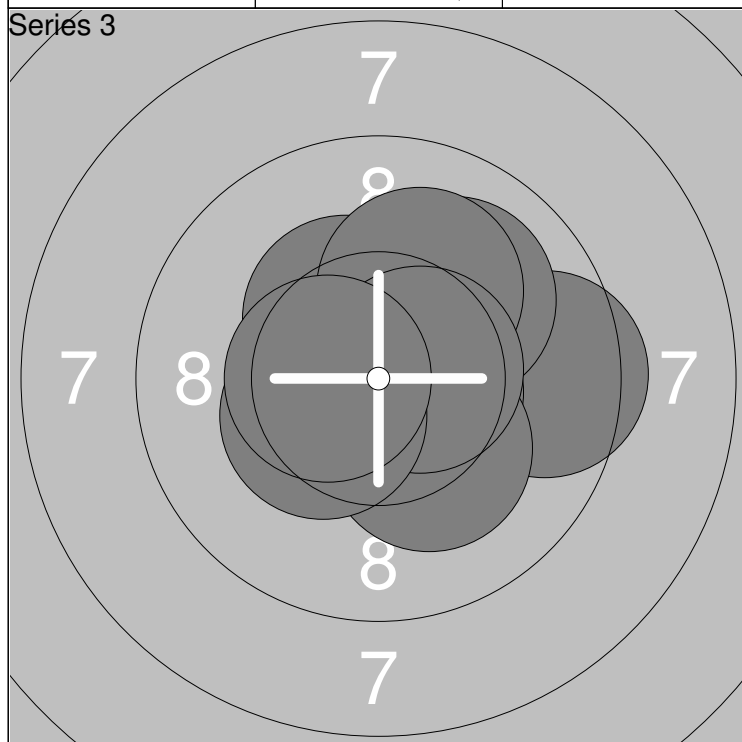

21: 9.5 →	26: 10.0 ↗	Series	103.1
22: 10.4x ↗	27: 10.1 ↑		
23: 10.6x →	28: 10.6x →	Total	309.8
24: 10.2x ↓	29: 10.4x ↙		
25: 10.8x ←	30: 10.5x ←		

31: 10.2x ↙	36: 9.9 →	Series	101.2
32: 10.6x ↗	37: 10.2x ↑		
33: 9.9 →	38: 10.0 ↙	Total	411.0
34: 10.5x ↓	39: 10.3x ←		
35: 10.4x ↗	40: 9.2 ↓		

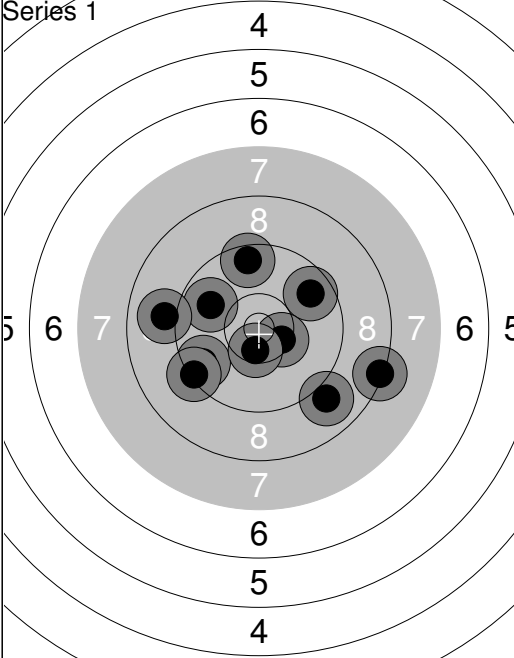
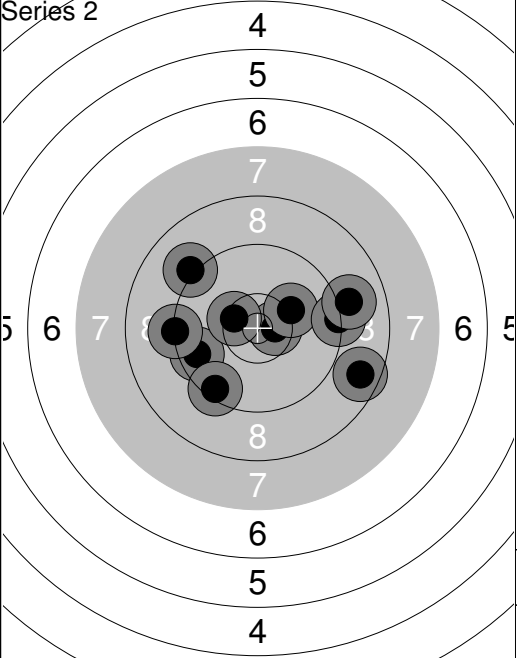
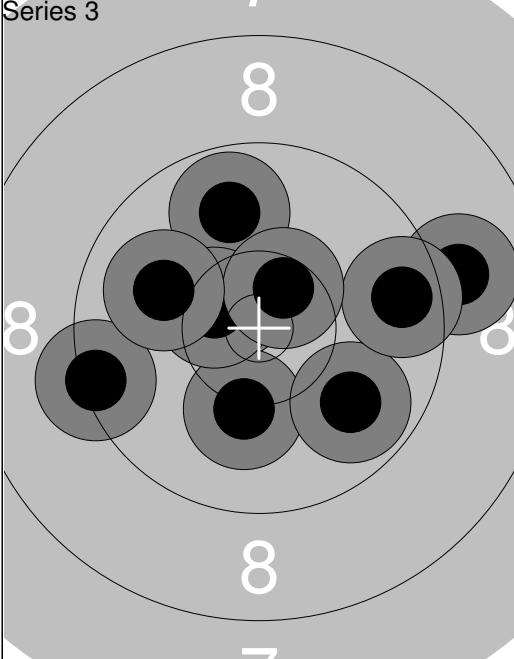
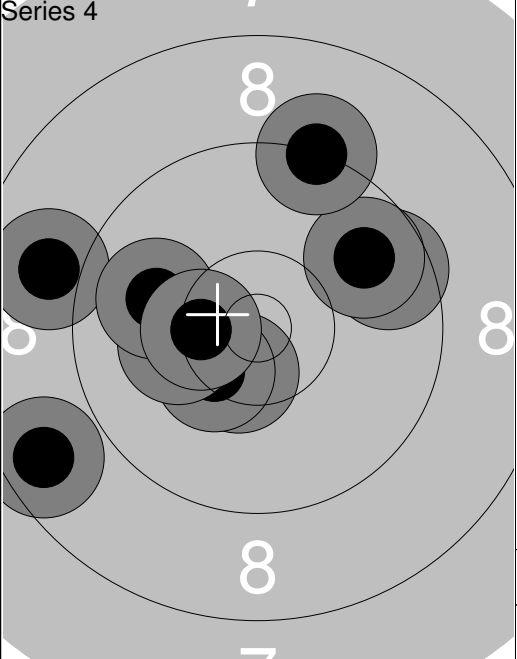
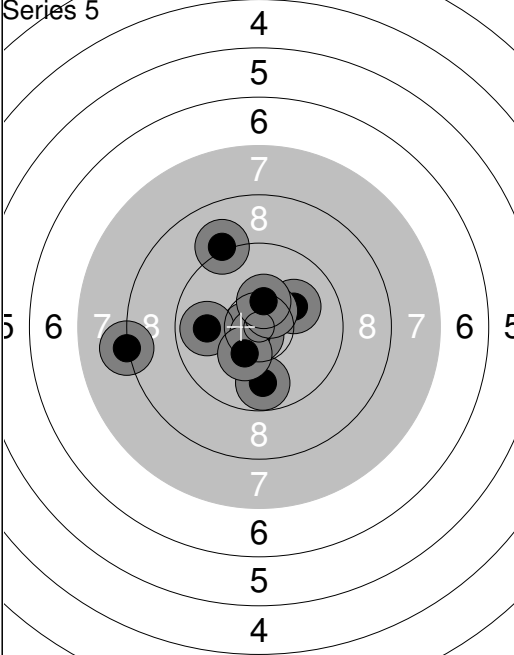
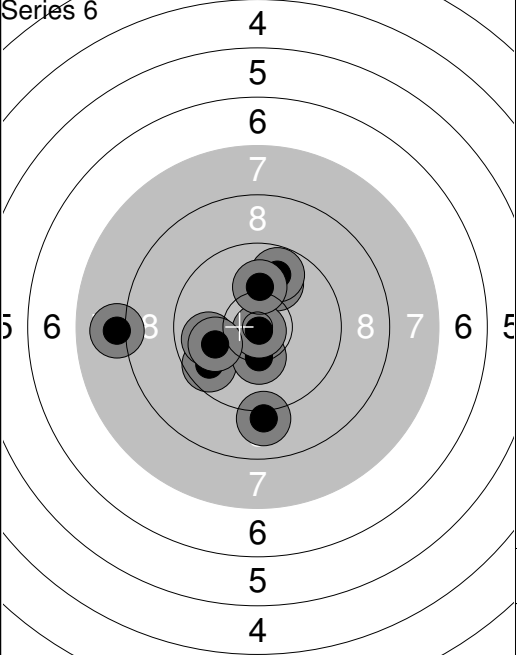
Relay	Lane	Antti Tervo	
1	9	SA	AP Y
16.-17.11.2013		Tauno Kärjen muistokilpailu	
		Kankaanpään Ampumaurheilijat	
Series 1 	1: 9.7 ↗	Series 2 	11: 9.6 ↖
	2: 9.6 ↖		12: 10.6x →
	3: 9.8 ↖		13: 9.1 ↖
	4: 8.3 →		14: 9.3 ↖
	5: 9.3 ↖		15: 10.2 ↗
	6: 9.0 ↖		16: 8.6 →
	7: 9.0 ↘		17: 9.3 →
	8: 10.4x →		18: 9.0 →
	9: 9.5 ↑		19: 9.4 ↘
	10: 10.5x ↓		20: 10.4x ↖
Series	95.1	Series	95.5
Total	95.1	Total	190.6
Series 3 	21: 10.6x ↖	Series 4 	31: 9.6 ↗
	22: 10.2 ↓		32: 8.9 ↖
	23: 9.9 ↘		33: 9.8 ↗
	24: 9.0 →		34: 10.5x ↓
	25: 9.6 →		35: 10.4x ↖
	26: 9.8 ↑		36: 10.2 ↖
	27: 10.5x ↖		37: 10.0 ↖
	28: 10.5x ↗		38: 8.6 ↖
	29: 9.4 ↖		39: 10.4x ↖
	30: 10.0 ↖		40: 9.2 ↑
Series	99.5	Series	97.6
Total	290.1	Total	387.7
Series 5 	41: 10.7x ↖	Series 6 	51: 9.7 ↖
	42: 9.1 ↑		52: 10.0 ↑
	43: 9.9 ↖		53: 10.3 ↓
	44: 10.1 ↗		54: 9.1 ↓
	45: 10.8x ↓		55: 9.9 ↖
	46: 9.8 ↓		56: 9.8 ↑
	47: 10.3 ↓		57: 8.1 ↖
	48: 10.6x ↗		58: 10.9x ↓
	49: 8.2 ↖		59: 10.0 ↖
	50: 10.4x ↑		60: 10.1 ↑
Series	99.9	Series	97.9
Total	487.6	Total	585.5

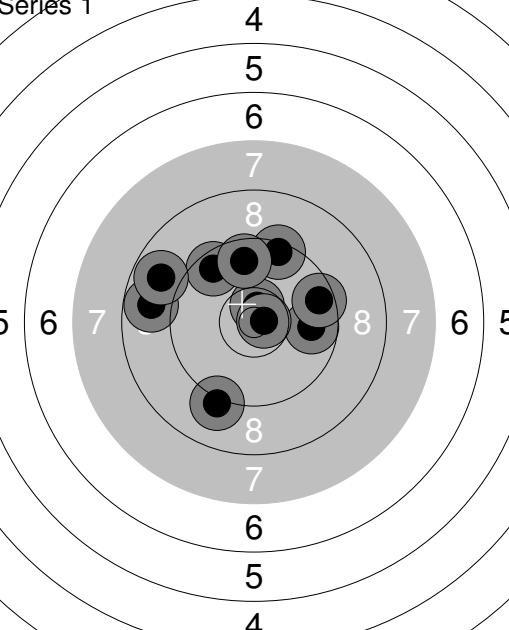
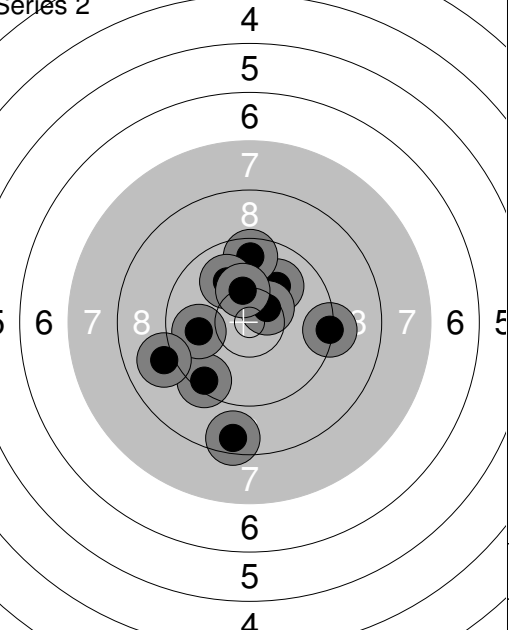
<p>Series 1</p> 	<p>1: 9.8 →</p> <p>2: 9.6 ↗</p> <p>3: 9.1 ↓</p> <p>4: 10.6x ↑</p> <p>5: 9.4 ↑</p> <p>6: 10.8x →</p> <p>7: 8.8 ←</p> <p>8: 8.8 ←</p> <p>9: 9.5 →</p> <p>10: 9.7 ↑</p> <hr/> <p>Series 96.1</p> <hr/> <p>Total 96.1</p>	<p>Series 2</p> 	<p>11: 9.3 →</p> <p>12: 9.4 ↘</p> <p>13: 9.9 ←</p> <p>14: 9.0 ↙</p> <p>15: 10.0 ↗</p> <p>16: 9.6 ↑</p> <p>17: 10.5x ↗</p> <p>18: 10.0 ↖</p> <p>19: 10.3 ↑</p> <p>20: 8.5 ↓</p> <hr/> <p>Series 96.5</p> <hr/> <p>Total 192.6</p>
--	---	--	--

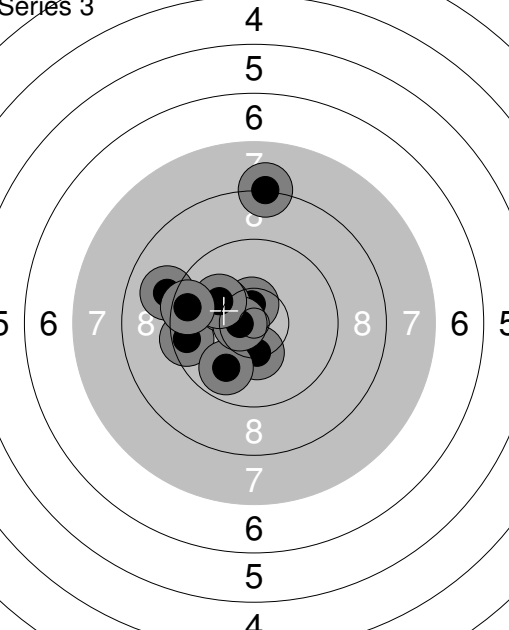
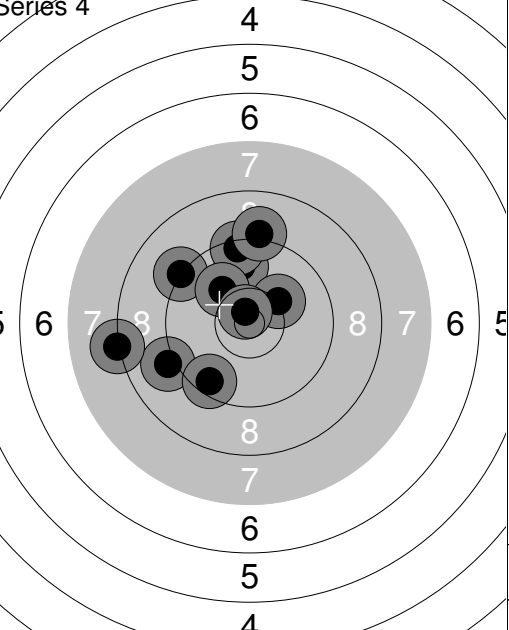
<p>Series 3</p> 	<p>21: 10.6x ↑</p> <p>22: 10.3 ↓</p> <p>23: 8.2 ↑</p> <p>24: 9.5 ←</p> <p>25: 9.1 ←</p> <p>26: 9.9 ↓</p> <p>27: 10.2 ↖</p> <p>28: 10.7x ←</p> <p>29: 10.1 ↖</p> <p>30: 9.5 ←</p> <hr/> <p>Series 98.1</p> <hr/> <p>Total 290.7</p>	<p>Series 4</p> 	<p>31: 9.8 ↑</p> <p>32: 10.2 ↗</p> <p>33: 9.4 ↑</p> <p>34: 9.1 ↑</p> <p>35: 9.2 ↖</p> <p>36: 9.1 ↙</p> <p>37: 10.1 ↖</p> <p>38: 9.5 ↓</p> <p>39: 8.2 ←</p> <p>40: 10.7x ↖</p> <hr/> <p>Series 95.3</p> <hr/> <p>Total 386.0</p>
---	--	---	---

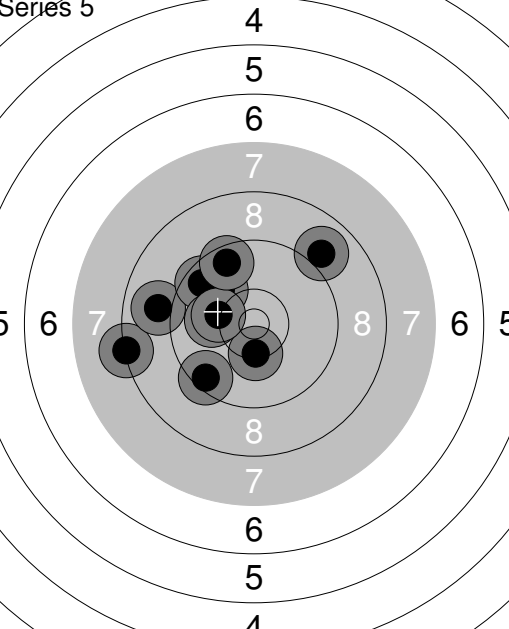
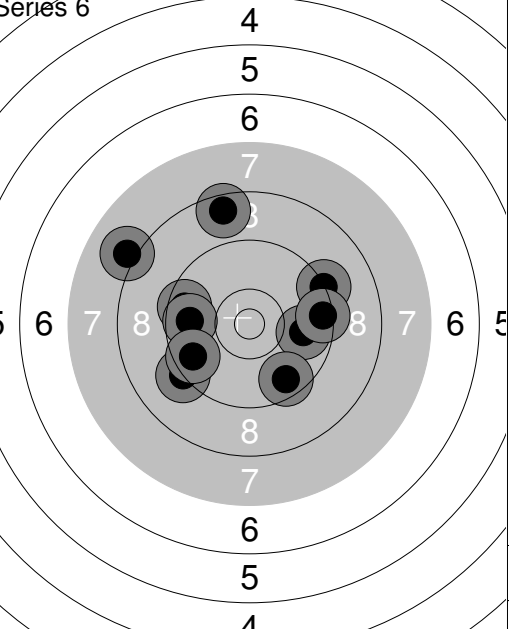
<p>Series 5</p> 	<p>41: 9.5 ↘</p> <p>42: 10.0 ↖</p> <p>43: 8.3 ←</p> <p>44: 9.0 ←</p> <p>45: 10.3 ↓</p> <p>46: 9.6 ↗</p> <p>47: 10.1 ←</p> <p>48: 10.2 ←</p> <p>49: 9.6 ↑</p> <p>50: 9.0 ↗</p> <hr/> <p>Series 95.6</p> <hr/> <p>Total 481.6</p>	<p>Series 6</p> 	<p>51: 9.8 →</p> <p>52: 9.3 ↗</p> <p>53: 9.2 ↙</p> <p>54: 9.6 ↓</p> <p>55: 8.6 ↑</p> <p>56: 9.4 →</p> <p>57: 9.6 ←</p> <p>58: 8.1 ↖</p> <p>59: 9.7 ←</p> <p>60: 9.6 ↙</p> <hr/> <p>Series 92.9</p> <hr/> <p>Total 574.5</p>
--	---	--	---

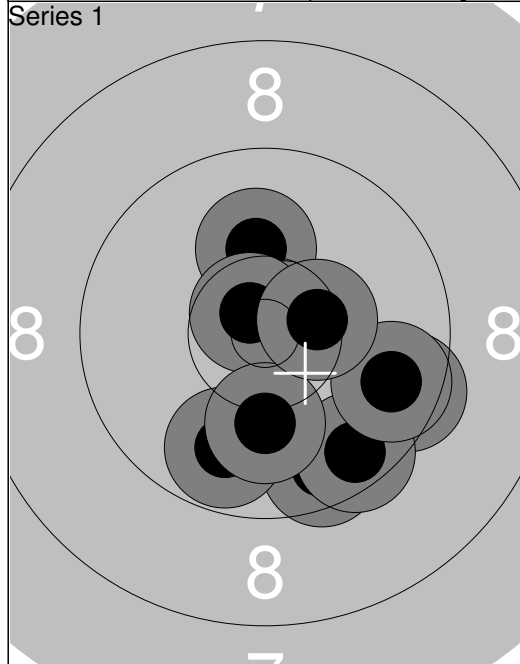

1:	9.6	↘
2:	9.5	→
3:	9.8	↘
4:	10.2	↑
5:	10.7x	↗
6:	9.6	↘
7:	10.7x	↖
8:	9.7	→
9:	10.1	↘
10:	10.4x	↗
Series		100.3
Total		100.3

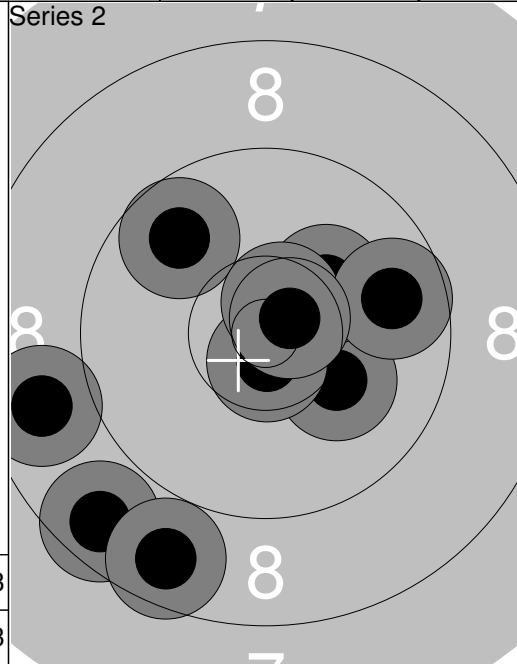

11:	8.6	↙
12:	10.2	↘
13:	9.8	↖
14:	10.7x	↘
15:	8.8	←
16:	8.7	↘
17:	10.2	↗
18:	10.6x	↗
19:	9.7	→
20:	10.7x	↗
Series		98.0
Total		198.3

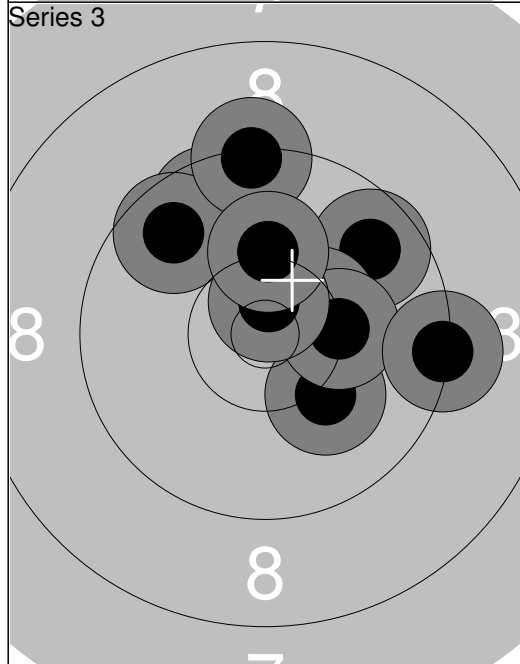

21:	9.7	↗
22:	10.2	↘
23:	10.4x	↗
24:	10.3	→
25:	9.7	↑
26:	9.7	↖
27:	10.7x	↑
28:	9.3	→
29:	9.3	↑
30:	10.2	↑
Series		99.5
Total		297.8

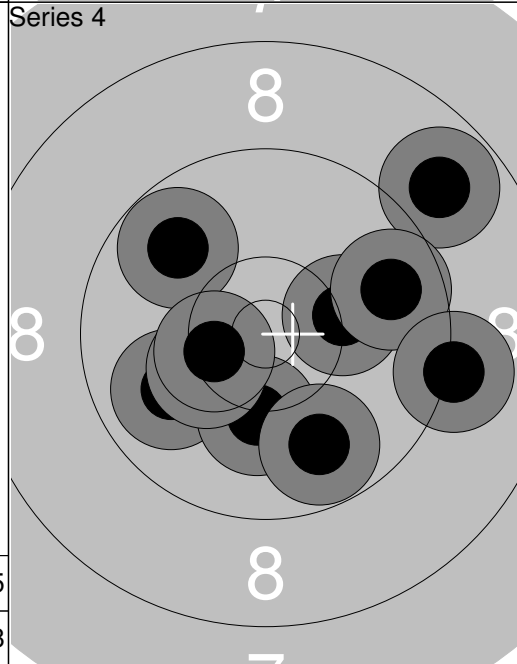

31:	9.9	↖
32:	10.2	→
33:	10.2	↘
34:	10.3	↖
35:	9.8	↖
36:	8.8	↗
37:	9.8	↘
38:	10.5x	↖
39:	9.7	→
40:	9.2	→
Series		98.4
Total		396.2

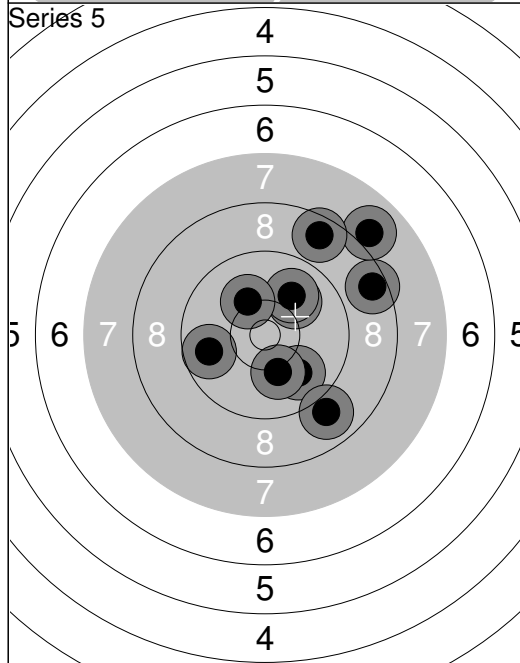

41:	8.5	→
42:	10.1	↗
43:	10.0	↗
44:	9.9	↘
45:	10.2	↖
46:	8.0	↗
47:	10.1	↘
48:	9.8	←
49:	8.9	↘
50:	8.6	↗
Series		94.1
Total		490.3

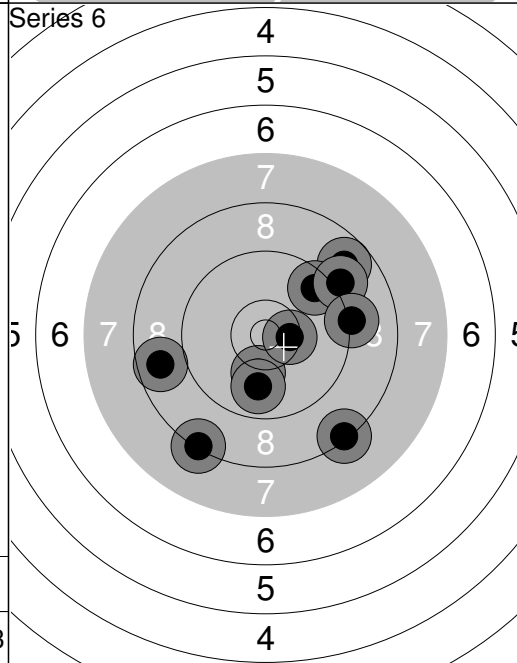

51:	8.3	↘
52:	8.8	↗
53:	9.6	↗
54:	9.1	↗
55:	10.2	↘
56:	9.2	→
57:	9.9	↘
58:	10.4x	→
59:	8.3	↘
60:	8.7	←
Series		92.5
Total		582.8

Relay	Lane	Jesse Peltomäki	
1	12	P-HA	AP Y
16.-17.11.2013		Tauno Kärjen muistokilpailu	
		Kankaanpään Ampumaurheilijat	
	1: 9.0 →		11: 10.5x ↙
	2: 10.7x →		12: 10.7x →
	3: 9.5 →		13: 9.6 ↙
	4: 10.0 ↙		14: 10.0 ↗
	5: 10.1 →		15: 9.8 ↗
	6: 10.1 ↘		16: 9.9 ↖
	7: 10.4x ↗		17: 10.0 ↙
	8: 10.2 ↗		18: 9.9 ↙
	9: 8.7 ←		19: 9.5 →
	10: 9.9 →		20: 10.4x ↗
	Series 98.6		Series 100.3
	Total 98.6		Total 198.9
	21: 10.2 ←		31: 10.0 ↗
	22: 9.3 ↖		32: 10.2 ↘
	23: 10.1 ↘		33: 10.5x ↗
	24: 10.5x ↗		34: 10.0 ↘
	25: 10.7x ↖		35: 10.7x →
	26: 9.5 ↘		36: 10.7x ↗
	27: 9.4 →		37: 9.2 ↗
	28: 10.6x ↘		38: 10.4x ↖
	29: 10.1 →		39: 10.5x ↘
	30: 10.0 →		40: 9.9 ↖
	Series 100.4		Series 102.1
	Total 299.3		Total 401.4
	41: 10.1 →		51: 9.3 ↖
	42: 10.1 ←		52: 10.0 ↖
	43: 10.1 ←		53: 9.9 ↘
	44: 9.8 →		54: 10.6x →
	45: 10.7x ↘		55: 10.1 →
	46: 9.9 ↖		56: 10.2 ↘
	47: 10.1 ↗		57: 9.2 ↘
	48: 9.3 ↘		58: 10.5x ↖
	49: 10.3 ↘		59: 10.4x ↗
	50: 10.0 ↘		60: 10.5x →
	Series 100.4		Series 100.7
	Total 501.8		Total 602.5

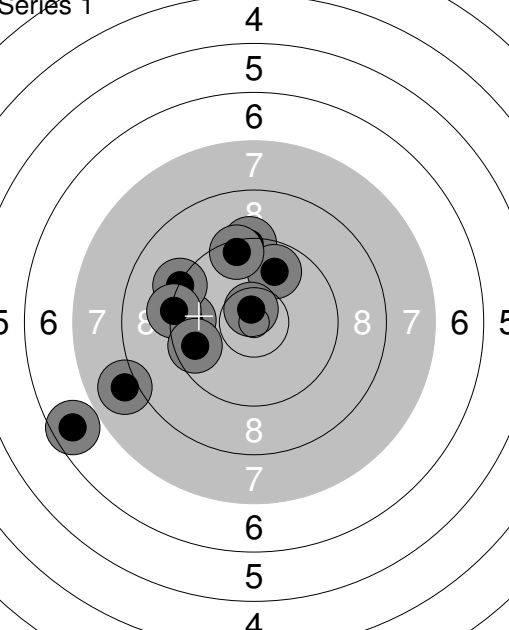
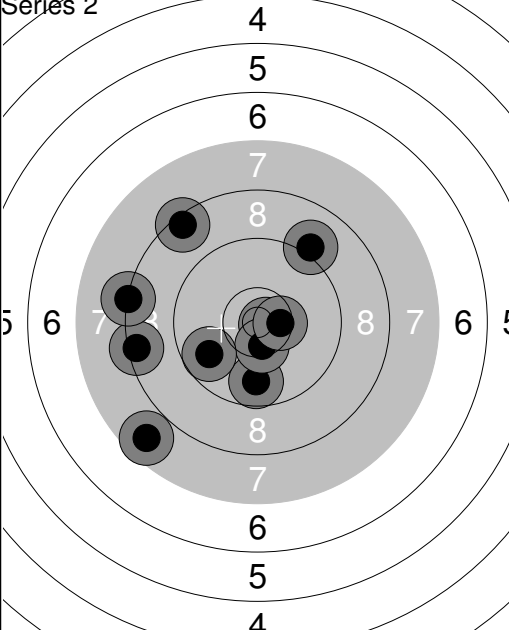
<p>Series 1</p> 	<p>1: 9.6 ←</p> <p>2: 9.3 ↑</p> <p>3: 9.8 ↗</p> <p>4: 6.6 ←</p> <p>5: 9.5 ↑</p> <p>6: 9.2 ↖</p> <p>7: 10.7x ↑</p> <p>8: 9.3 ←</p> <p>9: 8.0 ←</p> <p>10: 9.7 ←</p> <p>Series 91.7</p> <p>Total 91.7</p>	<p>Series 2</p> 	<p>11: 10.8x →</p> <p>12: 9.7 ↓</p> <p>13: 8.4 ↖</p> <p>14: 10.5x ↓</p> <p>15: 9.8 ↖</p> <p>16: 8.4 ←</p> <p>17: 10.5x →</p> <p>18: 9.1 ↗</p> <p>19: 8.3 ←</p> <p>20: 7.7 ↘</p> <p>Series 93.2</p> <p>Total 184.9</p>
--	---	--	---

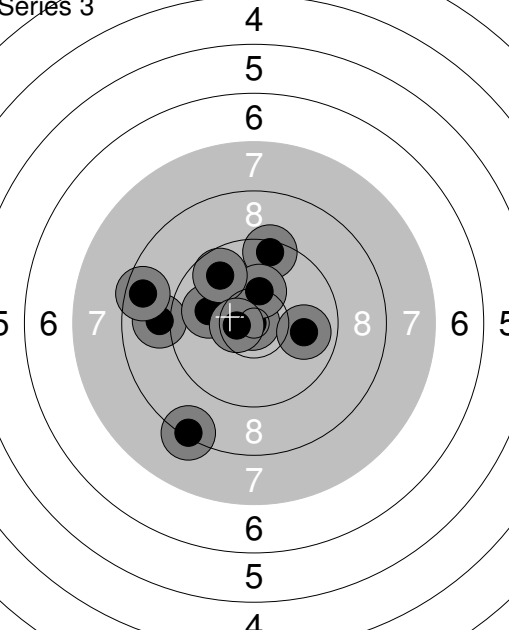
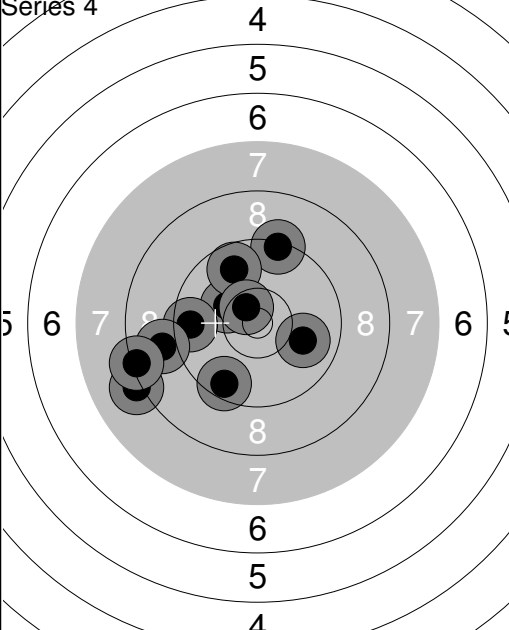
<p>Series 3</p> 	<p>21: 10.9x ←</p> <p>22: 9.0 ←</p> <p>23: 8.3 ↘</p> <p>24: 9.4 ↑</p> <p>25: 10.3 ↑</p> <p>26: 9.9 →</p> <p>27: 10.0 ←</p> <p>28: 8.6 ←</p> <p>29: 9.8 ↗</p> <p>30: 10.6x ←</p> <p>Series 96.8</p> <p>Total 281.7</p>	<p>Series 4</p> 	<p>31: 9.3 ↑</p> <p>32: 10.0 →</p> <p>33: 8.1 ↖</p> <p>34: 10.2 ↖</p> <p>35: 9.7 ↑</p> <p>36: 10.6x ↖</p> <p>37: 9.6 ←</p> <p>38: 8.9 ←</p> <p>39: 8.3 ←</p> <p>40: 9.5 ↘</p> <p>Series 94.2</p> <p>Total 375.9</p>
---	---	---	---

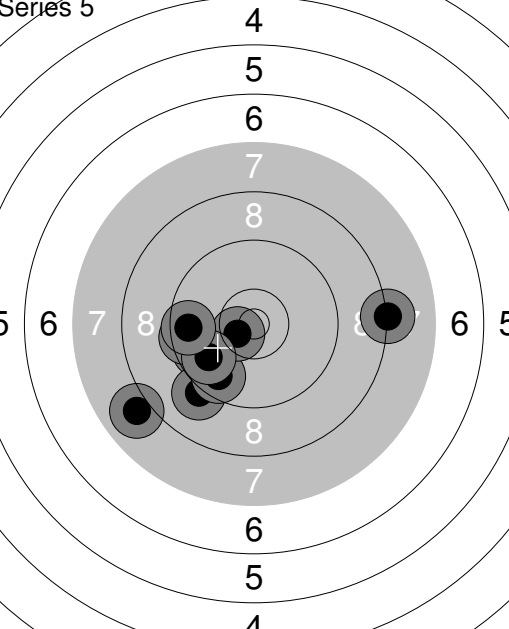
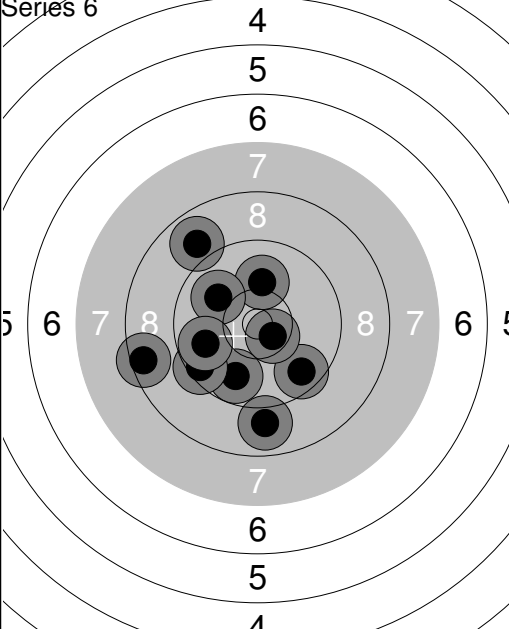
<p>Series 5</p> 	<p>41: 8.2 →</p> <p>42: 9.7 ↖</p> <p>43: 9.1 ↘</p> <p>44: 9.7 ↘</p> <p>45: 10.6x ↖</p> <p>46: 9.6 ←</p> <p>47: 9.5 ←</p> <p>48: 9.8 ↖</p> <p>49: 9.6 ←</p> <p>50: 8.0 ↖</p> <p>Series 93.8</p> <p>Total 469.7</p>	<p>Series 6</p> 	<p>51: 9.8 ↘</p> <p>52: 8.5 ←</p> <p>53: 8.9 ↗</p> <p>54: 9.6 ↘</p> <p>55: 10.5x ↘</p> <p>56: 10.1 ↑</p> <p>57: 9.5 ↖</p> <p>58: 10.0 ↖</p> <p>59: 9.8 ↖</p> <p>60: 8.9 ↓</p> <p>Series 95.6</p> <p>Total 565.3</p>
--	---	--	---

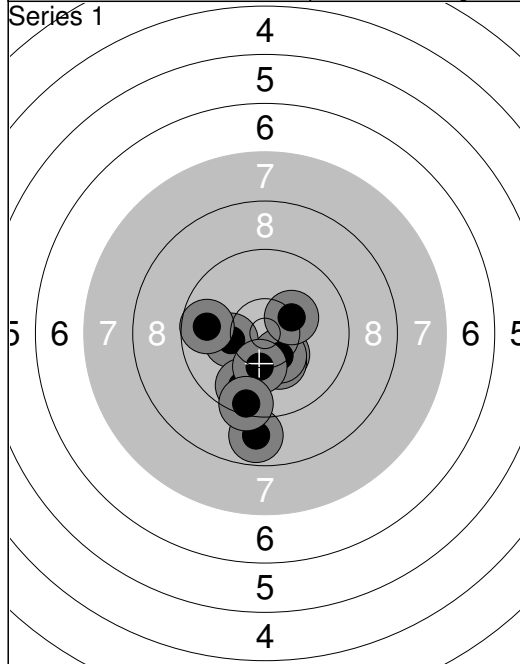

1: 10.4x ↘
2: 10.3 ↓
3: 10.4x ↘
4: 10.3 ↗
5: 10.2 ←
6: 9.8 ↓
7: 8.8 ↓
8: 10.3 ↓
9: 9.4 ↓
10: 9.7 ←
Series 99.6
Total 99.6

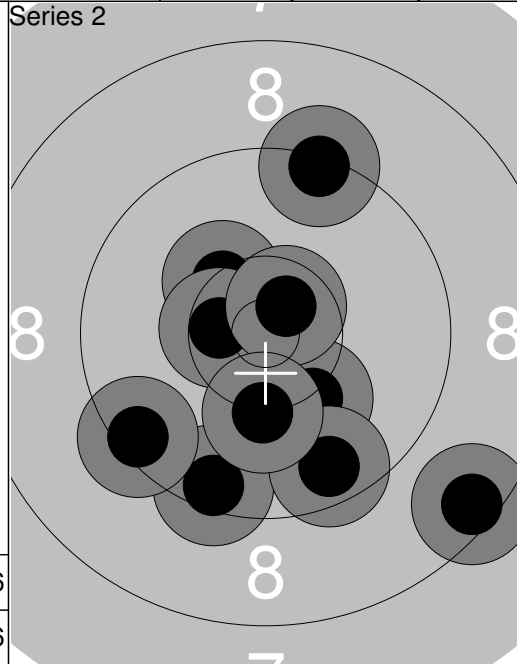

11: 10.3 ↖
12: 10.5x ←
13: 8.5 ↘
14: 9.5 ↓
15: 10.2 ↘
16: 10.6x ↗
17: 9.4 ↖
18: 9.6 ↓
19: 9.3 ↗
20: 10.2 ↓
Series 98.1
Total 197.7

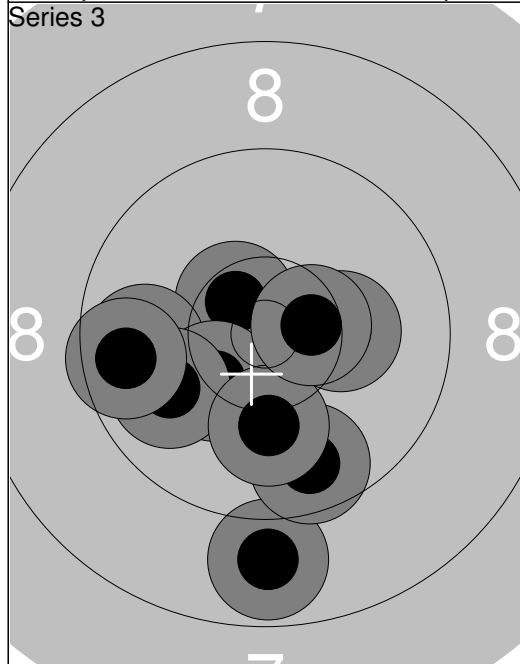

21: 8.9 ↓
22: 10.5x ↖
23: 9.8 ←
24: 10.2 →
25: 10.3 ↖
26: 9.9 ←
27: 9.7 ↓
28: 10.1 ↓
29: 9.6 ←
30: 10.5x →
Series 99.5
Total 297.2

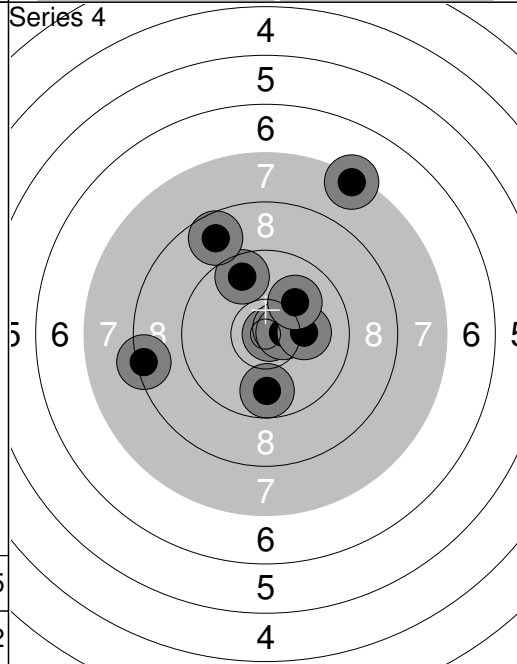

31: 7.4 ↗
32: 10.9x →
33: 10.6x →
34: 8.4 ←
35: 10.6x →
36: 10.2 →
37: 9.7 ↗
38: 9.8 ↓
39: 8.7 ↗
40: 10.1 ↗
Series 96.4
Total 393.6

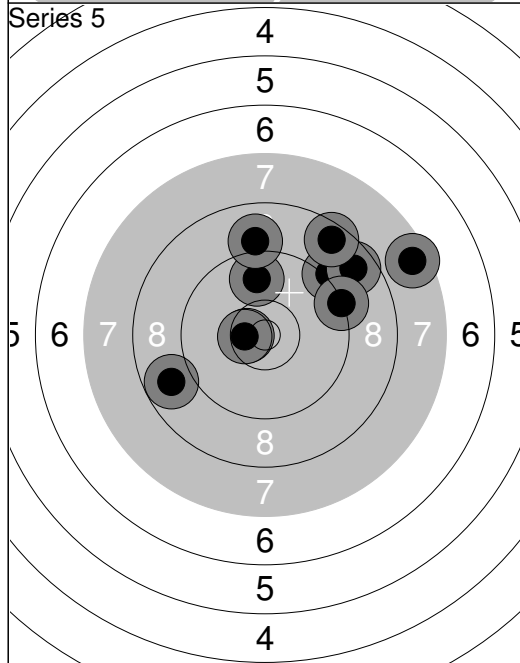

41: 10.6x ←
42: 9.1 ↗
43: 10.5x ←
44: 9.8 ↑
45: 8.7 ↗
46: 9.3 →
47: 7.6 ↗
48: 9.0 ↑
49: 8.8 ↖
50: 8.6 ↗
Series 92.0
Total 485.6

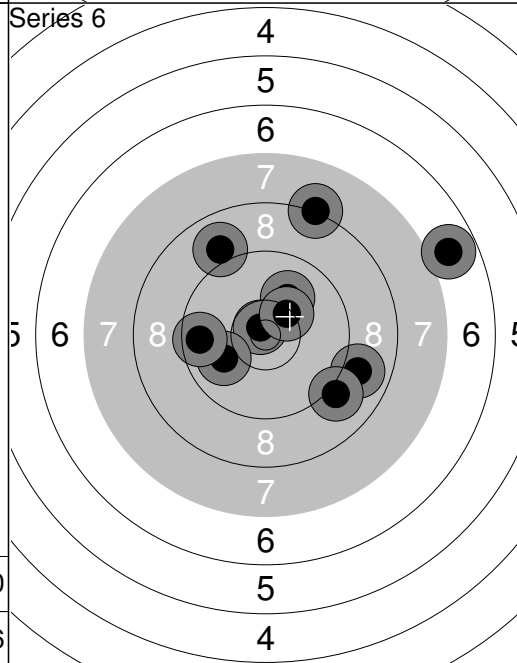

51: 8.9 →
52: 10.1 ↗
53: 10.8x ↖
54: 10.0 ↖
55: 9.0 ↖
56: 8.2 ↗
57: 9.1 ↘
58: 10.3 ↗
59: 6.8 →
60: 9.6 ←
Series 92.8
Total 578.4

Relay 1	Lane 15	Arttu Niittymies	
-------------------	-------------------	-------------------------	--

Air	P-HA	AP Y
-----	------	------

16.-17.11.2013	Tauno Kärjen muistokilpailu	Kankaanpään Ampumaurheilijat
----------------	-----------------------------	------------------------------

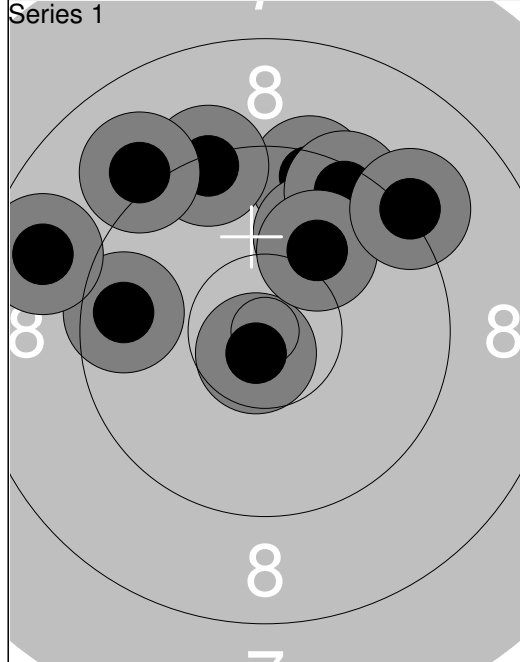

1:	9.5	↗
2:	9.9	↗
3:	9.5	↗
4:	9.6	←
5:	10.7x	↘
6:	10.1	↗
7:	8.8	←
8:	9.2	↗
9:	9.3	↗
10:	9.1	↖
Series	95.7	
Total	95.7	

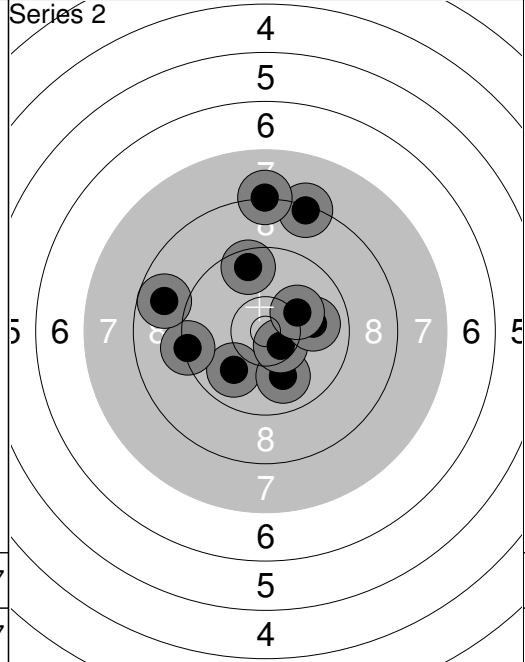

11:	9.9	↘
12:	9.3	←
13:	8.3	↗
14:	8.8	←
15:	8.2	↗
16:	10.0	↘
17:	10.5x	↘
18:	10.0	→
19:	10.2	↗
20:	9.6	↗
Series	94.8	
Total	190.5	

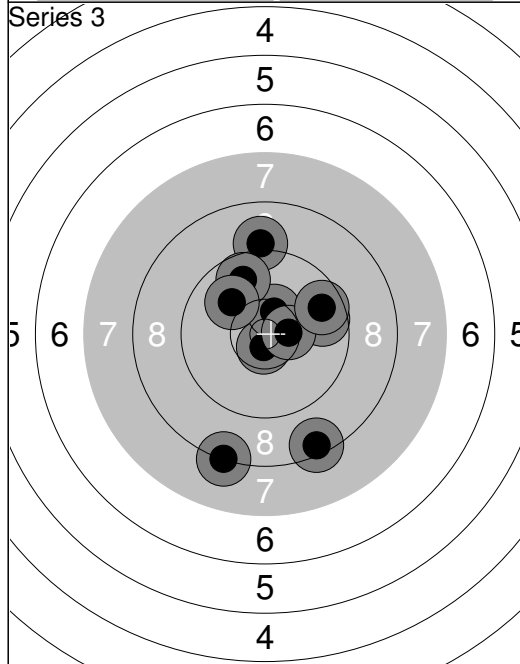

21:	8.2	↘
22:	9.1	↗
23:	10.7x	↘
24:	9.7	→
25:	10.5x	↗
26:	9.7	↗
27:	10.5x	→
28:	9.7	↗
29:	10.0	↖
30:	8.4	↘
Series	96.5	
Total	287.0	

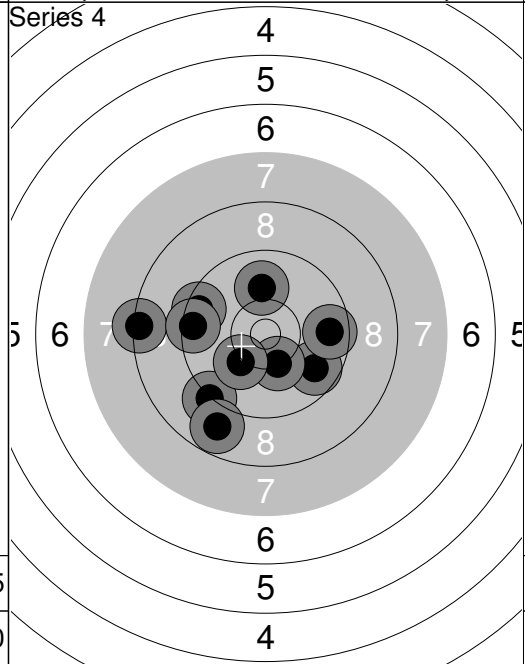

31:	9.7	↘
32:	9.2	↘
33:	8.4	←
34:	9.6	→
35:	8.8	↘
36:	10.3	↘
37:	10.2	↘
38:	9.5	←
39:	9.4	←
40:	10.0	↗
Series	95.1	
Total	382.1	

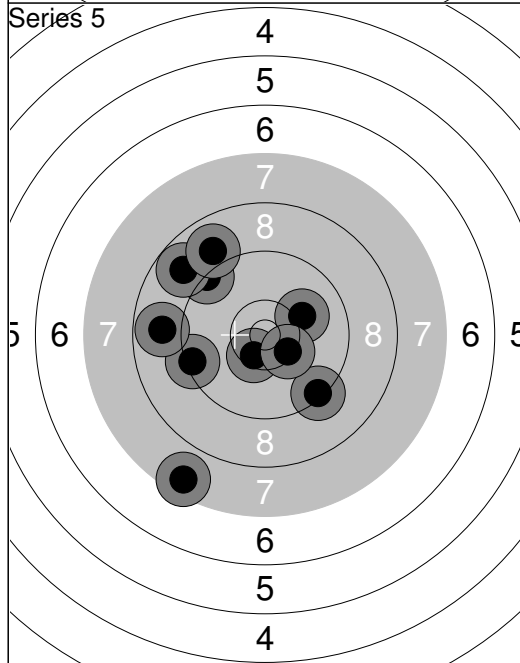

41:	9.4	←
42:	7.5	↘
43:	9.3	↗
44:	8.8	↗
45:	9.3	↘
46:	8.8	←
47:	8.9	↗
48:	10.5x	↘
49:	10.1	↗
50:	10.4x	↘
Series	93.0	
Total	475.1	

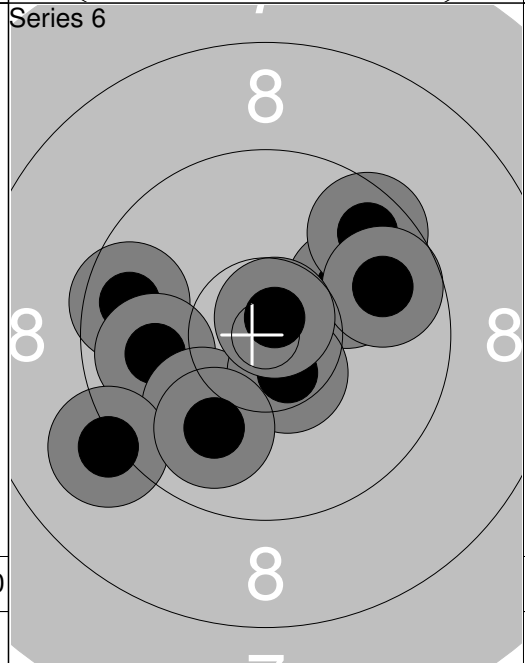

51:	9.7	←
52:	9.9	←
53:	10.1	↗
54:	9.6	↗
55:	9.8	↗
56:	10.1	↘
57:	9.2	←
58:	10.6x	↘
59:	10.0	↘
60:	10.8x	↗
Series	99.8	
Total	574.9	

<p>Series 1</p>	<p>1: 10.7x ↘ 2: 9.3 ↘ 3: 10.1 ↘ 4: 10.1 → 5: 8.2 ↘ 6: 10.0 ↑ 7: 9.7 ↖ 8: 9.4 → 9: 8.7 → 10: 10.9x ↖</p> <p>Series 97.1 Total 97.1</p>	<p>Series 2</p>	<p>11: 10.3 ↗ 12: 9.9 ↖ 13: 10.1 ↑ 14: 9.1 ↖ 15: 9.2 ↖ 16: 9.9 ↗ 17: 6.6 ↗ 18: 10.5x ↑ 19: 9.2 ↘ 20: 8.3 ↖</p> <p>Series 93.1 Total 190.2</p>
------------------------	--	------------------------	---

<p>Series 3</p>	<p>21: 9.7 ↖ 22: 8.1 ↖ 23: 9.4 ↖ 24: 9.7 → 25: 9.6 ↘ 26: 8.0 ↑ 27: 8.9 ↖ 28: 10.6x ↘ 29: 10.0 ↖ 30: 9.7 ↖</p> <p>Series 93.7 Total 283.9</p>	<p>Series 4</p>	<p>31: 8.8 ↗ 32: 9.8 ↘ 33: 10.9x ↗ 34: 9.1 ↑ 35: 9.7 ↖ 36: 9.5 ↑ 37: 9.4 ↘ 38: 8.9 ↘ 39: 10.1 → 40: 10.3 ↑</p> <p>Series 96.5 Total 380.4</p>
------------------------	--	------------------------	---

<p>Series 5</p>	<p>41: 7.6 ↑ 42: 8.8 → 43: 9.4 ↑ 44: 9.9 ↘ 45: 9.8 ↘ 46: 8.3 ↖ 47: 10.0 ↖ 48: 10.4x ↘ 49: 10.5x → 50: 9.2 ↘</p> <p>Series 93.9 Total 474.3</p>	<p>Series 6</p>	<p>51: 8.8 ↘ 52: 7.7 ↖ 53: 9.8 ↗ 54: 10.2 ↘ 55: 9.4 ↘ 56: 8.2 ↖ 57: 9.2 ↘ 58: 9.7 → 59: 9.3 ↘ 60: 10.0 ↘</p> <p>Series 92.3 Total 566.6</p>
------------------------	--	------------------------	---

Relay	Lane	Ville Lehtinen				
Air	P-HA	AP Y				
16.-17.11.2013	Tauno Kärjen muistokilpailu	Kankaanpään Ampumaurheilijat				
Series 1		1: 10.5x ←	Series 2		11: 8.6 ↓	
		2: 9.1 →			12: 9.6 →	
		3: 9.7 ←			13: 8.4 ←	
		4: 9.6 ↗			14: 8.7 ←	
		5: 8.5 ↓			15: 8.3 →	
		6: 8.4 ↗			16: 7.6 ↙	
		7: 10.1 →			17: 10.3 →	
		8: 9.4 ↗			18: 9.4 ↑	
		9: 10.1 ↓			19: 10.2 ↗	
		10: 9.8 ↙			20: 8.9 →	
	Series	95.2		Series	90.0	
	Total	95.2		Total	185.2	
Series 3		21: 10.0 →	Series 4		31: 10.3 →	
		22: 10.4x →				32: 10.5x ↗
		23: 9.5 ↓				33: 8.8 ↗
		24: 8.6 ↓				34: 9.4 ↘
		25: 10.0 →			35: 10.0 ↙	
		26: 8.8 ↗			36: 9.4 ↗	
		27: 10.1 ↗			37: 10.4x ↗	
		28: 7.7 ↗			38: 9.7 ↓	
		29: 9.1 ←			39: 9.6 ↙	
		30: 10.3 ↑			40: 10.5x ↗	
	Series	94.5		Series	98.6	
	Total	279.7		Total	378.3	
Series 5		41: 7.0 ↑	Series 6		51: 9.9 ↙	
		42: 8.6 ↙				52: 8.4 ↙
		43: 9.1 ↑				53: 9.0 ↑
		44: 10.6x ↓				54: 9.4 ↓
		45: 9.2 ←			55: 10.1 ↙	
		46: 10.4x ←			56: 8.8 →	
		47: 10.6x ↗			57: 9.3 ←	
		48: 10.1 ↗			58: 10.0 →	
		49: 10.1 →			59: 6.6 ↙	
		50: 10.5x ↓			60: 10.2 ↗	
	Series	96.2		Series	91.7	
	Total	474.5		Total	566.2	

Relay 1	Lane 18	Jyrki Pitkäranta	
-------------------	-------------------	-------------------------	--

Air	IU	AP Y
-----	----	------

16.-17.11.2013	Tauno Kärjen muistokilpailu	Kankaanpään Ampumaurheilijat
----------------	-----------------------------	------------------------------

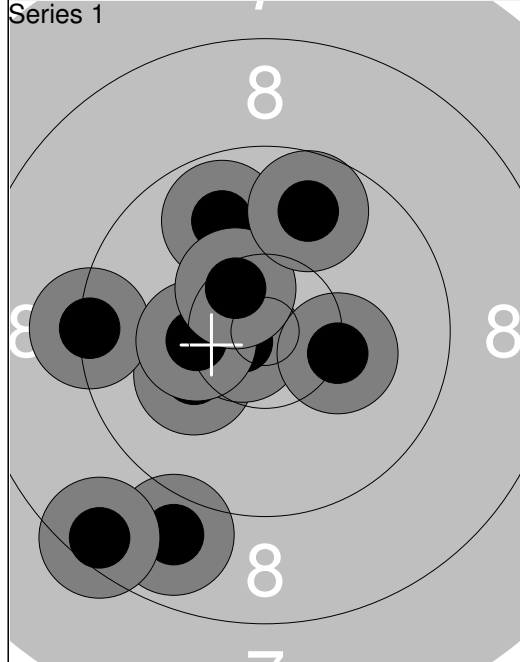

1:	10.2	↙
2:	10.7x	↙
3:	10.2	→
4:	9.3	←
5:	10.3	←
6:	8.9	↘
7:	8.5	↘
8:	9.8	↗
9:	10.5x	↗
10:	9.8	↗
Series	98.2	
Total	98.2	

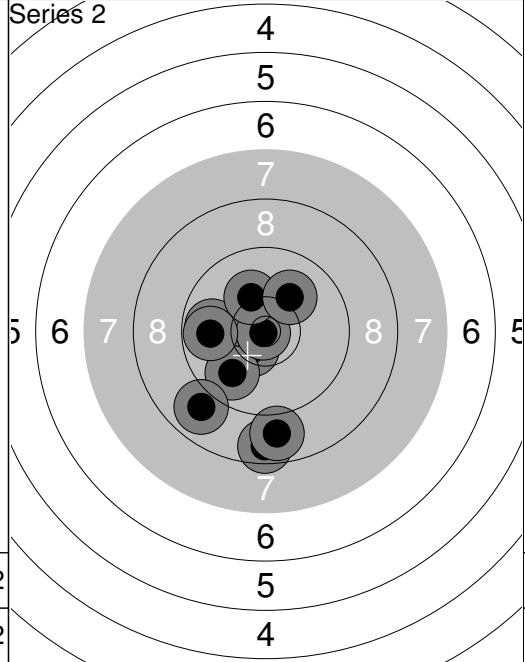

11:	8.6	↓
12:	10.5x	↘
13:	9.9	↘
14:	9.8	←
15:	8.8	↓
16:	10.9x	↙
17:	10.2	↗
18:	10.1	↗
19:	8.9	↘
20:	9.8	←
Series	97.5	
Total	195.7	

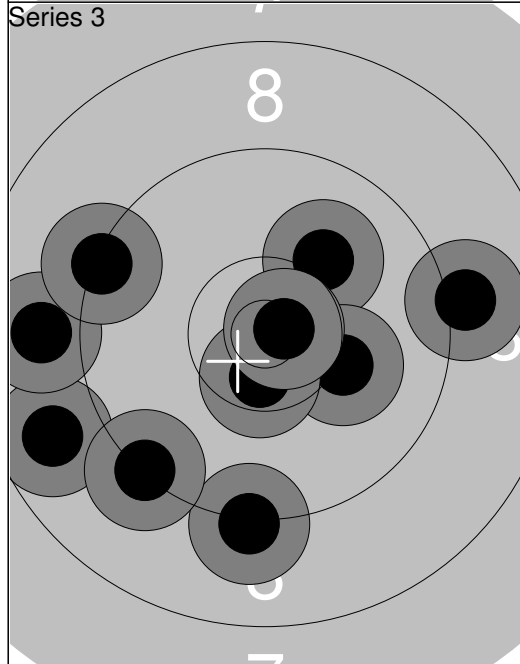

21:	8.8	↙
22:	9.1	→
23:	10.1	↗
24:	10.2	→
25:	8.9	←
26:	9.2	↓
27:	10.6x	↓
28:	10.8x	→
29:	9.3	↙
30:	9.3	↘
Series	96.3	
Total	292.0	

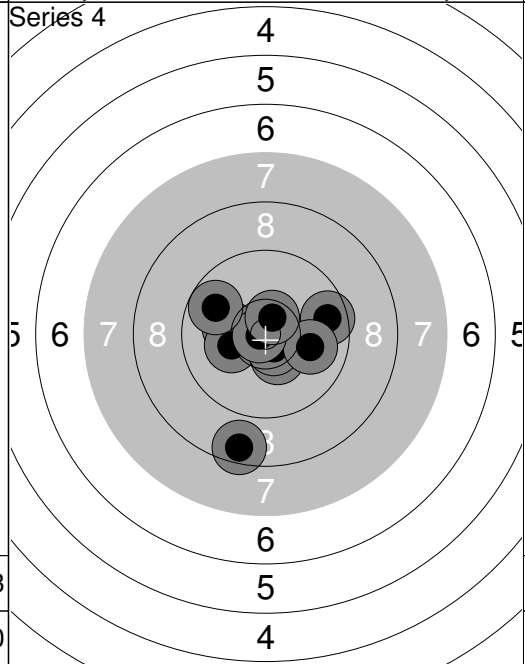

31:	10.2	←
32:	8.6	↓
33:	10.2	←
34:	10.4x	↓
35:	9.6	→
36:	10.6x	↓
37:	10.0	→
38:	10.8x	←
39:	9.8	↙
40:	10.6x	↗
Series	100.8	
Total	392.8	

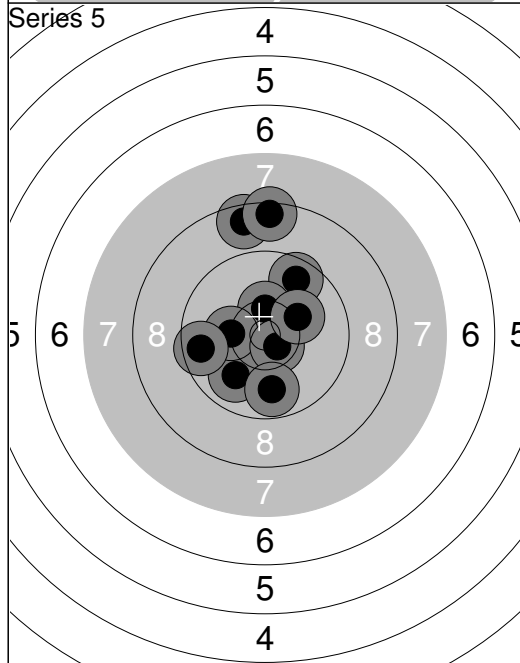

41:	9.9	↘
42:	9.7	↗
43:	10.4x	↑
44:	8.6	↑
45:	10.3	←
46:	10.6x	↘
47:	9.8	↓
48:	8.5	↑
49:	9.6	←
50:	10.2	↗
Series	97.6	
Total	490.4	

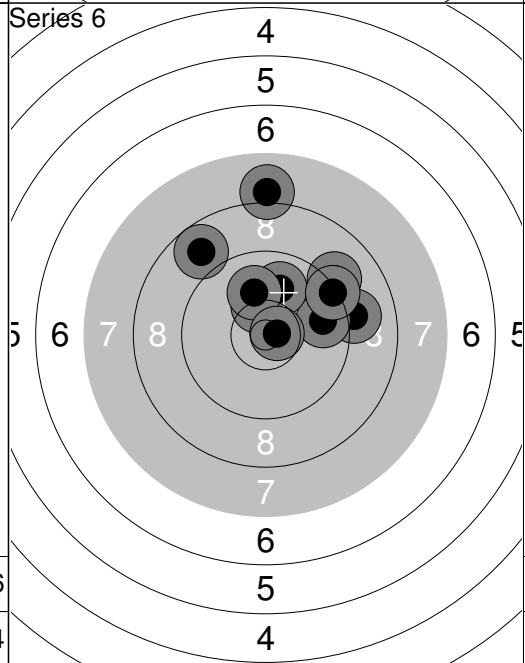

51:	9.1	↗
52:	8.0	↑
53:	9.1	→
54:	10.3	↑
55:	8.8	↘
56:	9.7	→
57:	10.0	↑
58:	10.0	↑
59:	9.3	↗
60:	10.7x	→
Series	95.0	
Total	585.4	

Relay	Lane	Kari Pirttimäki			
1	19	SsA	AP Y		
16.-17.11.2013		Tauno Kärjen muistokilpailu			
		Kankaanpään Ampumaurheilijat			
Series 1		1: 7.3 ↘	Series 2		11: 8.3 ←
		2: 9.9 ←			12: 9.1 ↓
		3: 10.4x ↓			13: 10.0 ←
		4: 10.3 →			14: 9.8 ↓
		5: 6.0 ↘			15: 7.5 ↘
		6: 9.0 ←			16: 8.0 ↓
		7: 9.6 ←			17: 9.1 ↓
		8: 9.0 ←			18: 9.8 ↗
		9: 7.9 ↘			19: 8.3 ↘
		10: 10.0 ↖			20: 8.6 ↘
Series 89.4		Series 88.5			
Total 89.4		Total 177.9			
Series 3		21: 9.7 ↓	Series 4		31: 9.1 ↓
		22: 8.3 ↘			32: 9.9 →
		23: 8.8 ↖			33: 8.0 ↓
		24: 9.2 ↘			34: 9.8 ↘
		25: 9.1 ↓			35: 9.9 ↘
		26: 8.9 ↓			36: 9.9 ↓
		27: 8.8 ↓			37: 9.9 ↓
		28: 8.5 →			38: 8.7 →
		29: 7.5 →			39: 9.9 ↓
		30: 9.7 ↓			40: 9.6 ↖
Series 88.5		Series 94.7			
Total 266.4		Total 361.1			
Series 5		41: 6.4 →	Series 6		51: 8.0 ↓
		42: 9.6 ↘			52: 10.6x ↓
		43: 8.8 →			53: 8.3 →
		44: 7.9 ↖			54: 9.3 ↓
		45: 8.6 ↗			55: 9.1 ↓
		46: 10.1 ↘			56: 8.8 ↖
		47: 10.1 →			57: 9.1 →
		48: 9.0 →			58: 7.5 ↘
		49: 8.0 →			59: 9.3 ↓
		50: 8.8 ↘			60: 8.5 ↓
Series 87.3		Series 88.5			
Total 448.4		Total 536.9			

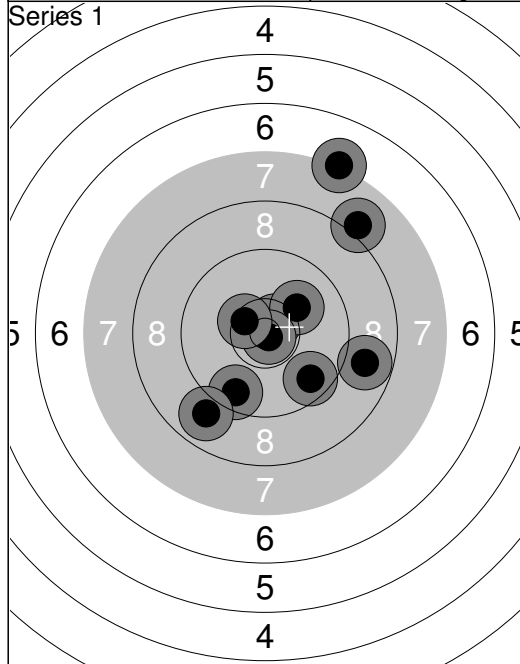

1: 9.6 ↘
2: 10.6x ↗
3: 8.9 ↘
4: 10.1 ↗
5: 10.8x ↘
6: 9.6 ↘
7: 7.2 ↗
8: 8.0 ↗
9: 8.8 →
10: 10.5x ↙
Series 94.1
Total 94.1

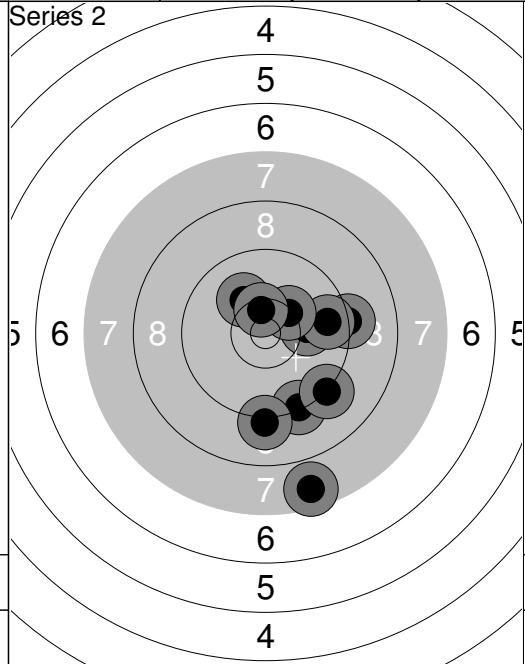

11: 9.2 →
12: 10.1 →
13: 7.6 ↘
14: 9.3 ↘
15: 10.1 ↗
16: 9.7 →
17: 9.2 ↘
18: 10.3 ↗
19: 10.5x ↑
20: 9.1 ↓
Series 95.1
Total 189.2

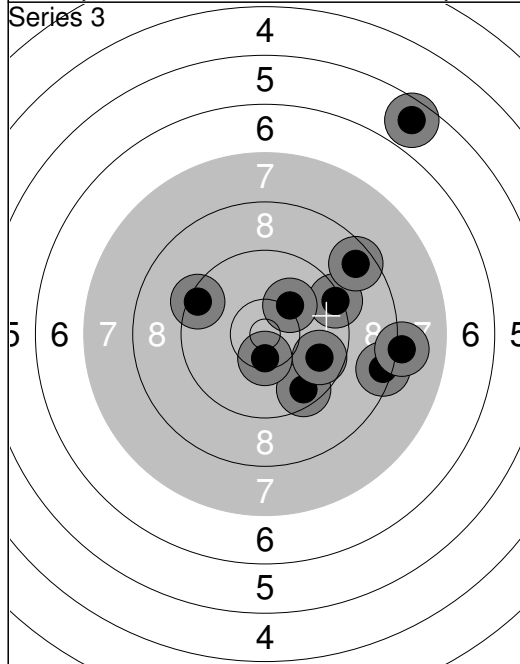

21: 9.4 ↗
22: 9.4 ↖
23: 8.4 →
24: 9.6 ↘
25: 10.2 ↗
26: 9.7 →
27: 8.6 ↗
28: 5.6 ↗
29: 8.1 →
30: 10.5x ↓
Series 89.5
Total 278.7

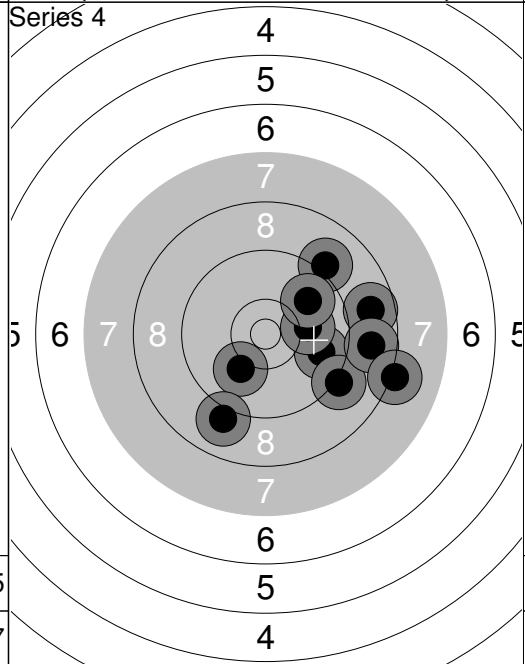

31: 9.1 ↗
32: 9.7 →
33: 9.1 ↘
34: 8.7 →
35: 8.8 →
36: 10.1 →
37: 10.1 ↘
38: 9.8 ↗
39: 8.2 →
40: 9.0 ↘
Series 92.6
Total 371.3

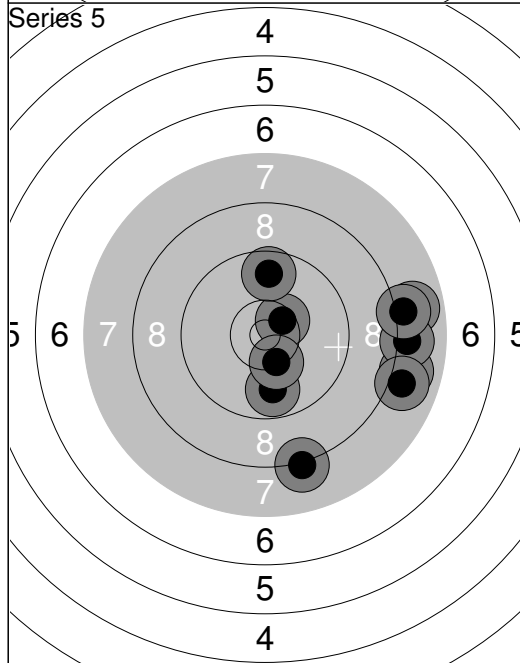

41: 10.5x ↗
42: 9.8 ↘
43: 8.0 →
44: 10.3 ↘
45: 8.2 ↘
46: 9.7 ↗
47: 7.9 →
48: 8.0 →
49: 8.1 →
50: 8.0 →
Series 88.5
Total 459.8

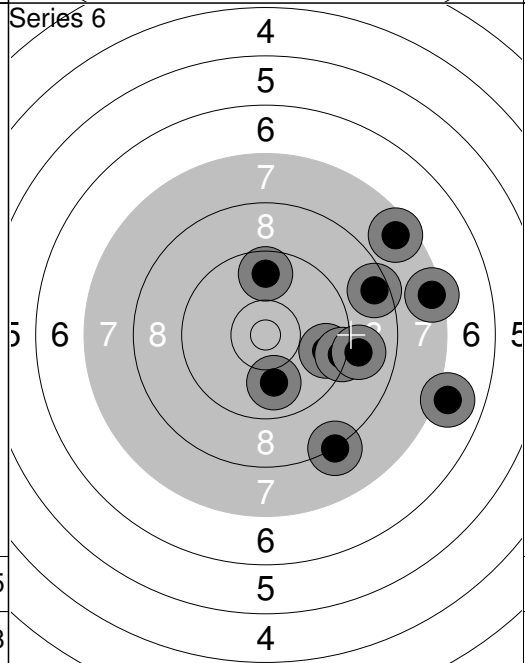

51: 9.7 →
52: 9.3 →
53: 9.0 →
54: 8.5 →
55: 7.6 ↗
56: 8.2 ↘
57: 7.4 →
58: 7.0 →
59: 10.0 ↓
60: 9.7 ↑
Series 86.4
Total 546.2