

1: 8.7 →	6: 8.6 →	Series	89.0
2: 8.9 ↗	7: *10.7 ↙		
3: 9.7 ←	8: *10.6 ↑	Total	89.0
4: 8.4 ←	9: *10.5 ↙		
5: *10.8 ↗	10: 8.5 →		

11: 9.7 ↖	16: 9.6 ↖	Series	93.0
12: *10.5 ↗	17: 9.2 ↗		
13: 9.8 ↗	18: *10.5 ↑	Total	182.0
14: 9.7 ↑	19: 10.1 ↗		
15: *10.4 ↘	20: 8.7 ↖		

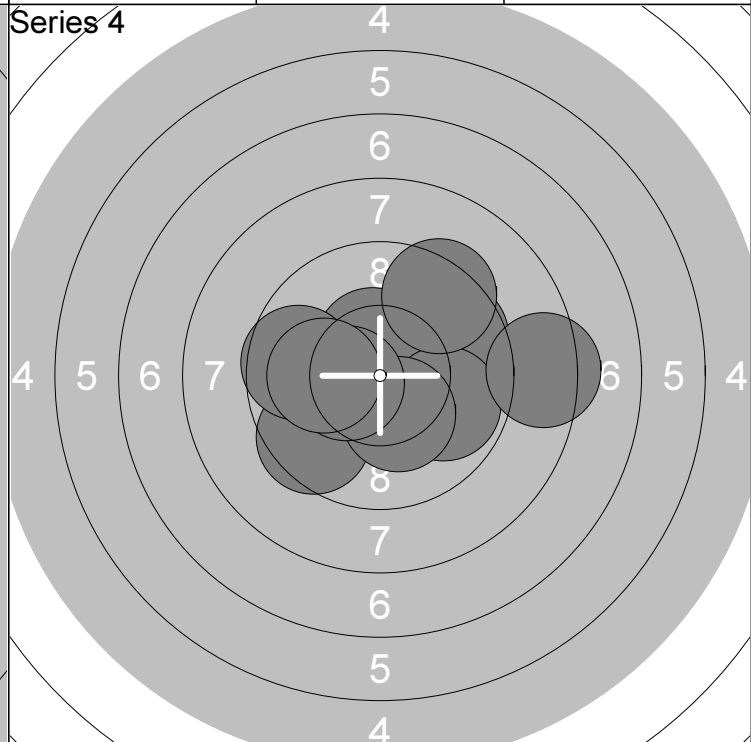
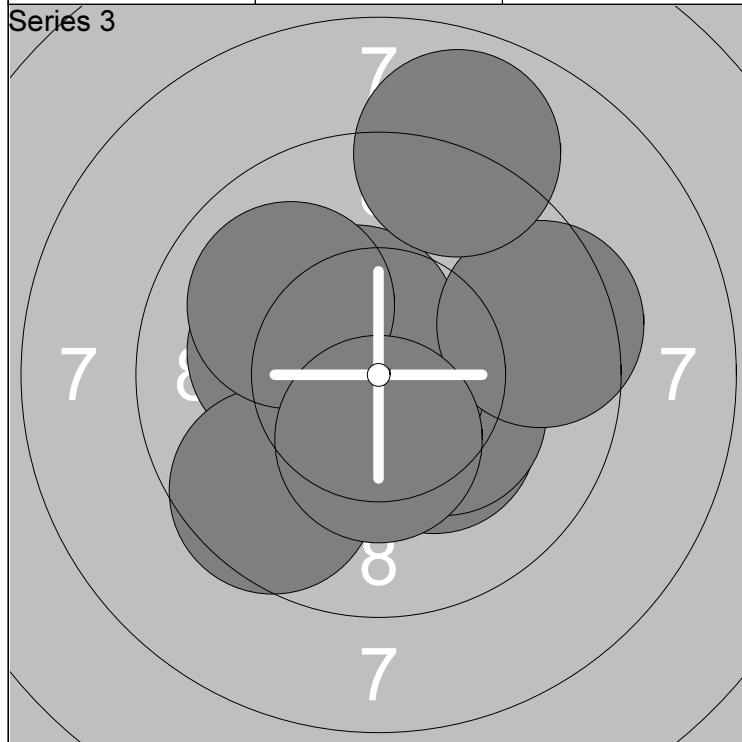

21: *10.2 ↙	26: 9.6 ↙	Series	96.0
22: *10.3 ↘	27: 10.0 ↖		
23: *10.3 ↘	28: 9.5 →	Total	278.0
24: *10.9 ↘	29: *10.4 ↓		
25: *10.5 ↗	30: 8.9 ↑		

31: 9.7 ↗	36: 9.7 ←	Series	93.0
32: *10.5 ↑	37: *10.4 ↙		
33: 9.5 ↙	38: 9.4 ↗	Total	371.0
34: 9.8 →	39: 10.1 ←		
35: *10.3 ↘	40: 8.4 →		

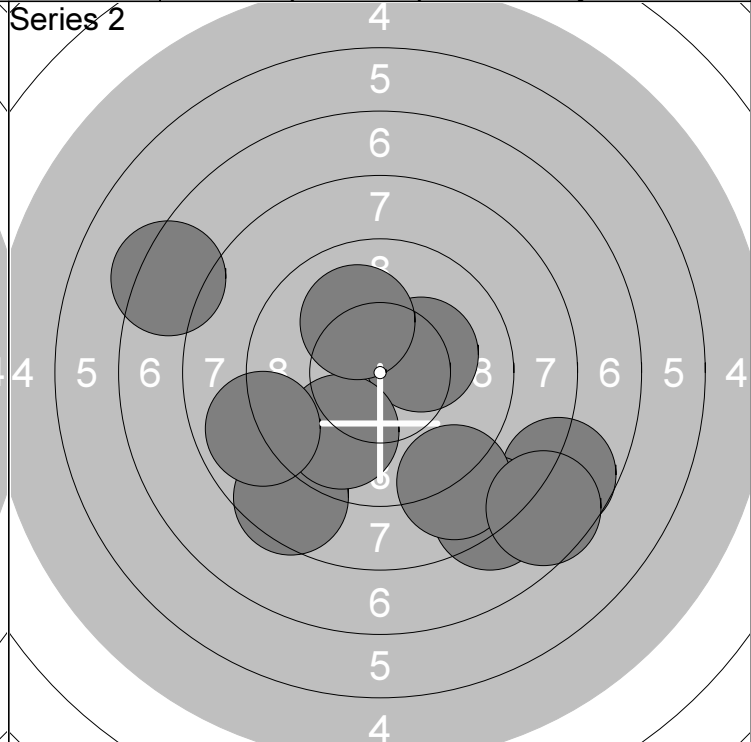
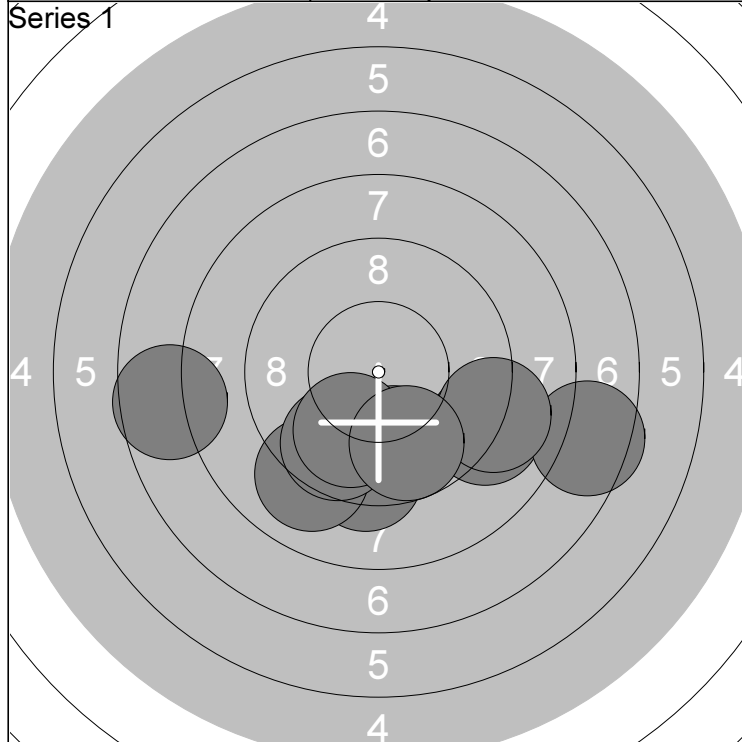

1: 9.0 →	6: 7.6 ←	Series	86.0	11: 7.7 →	16: 10.1 ↗	Series	82.0
2: 7.5 →	7: 9.0 →		Total	86.0	12: 8.1 ↓		17: 7.3 ↙
3: 9.8 ↓	8: 9.7 ↓	13: 8.6 ↓		18: 8.9 ↓			
4: 9.3 ↓	9: 9.9 ↓	14: *10.2 ↗	19: 8.9 ↙				
5: 9.0 ↙	10: 9.7 ↓	15: 9.9 ↓	20: 7.6 ↘				

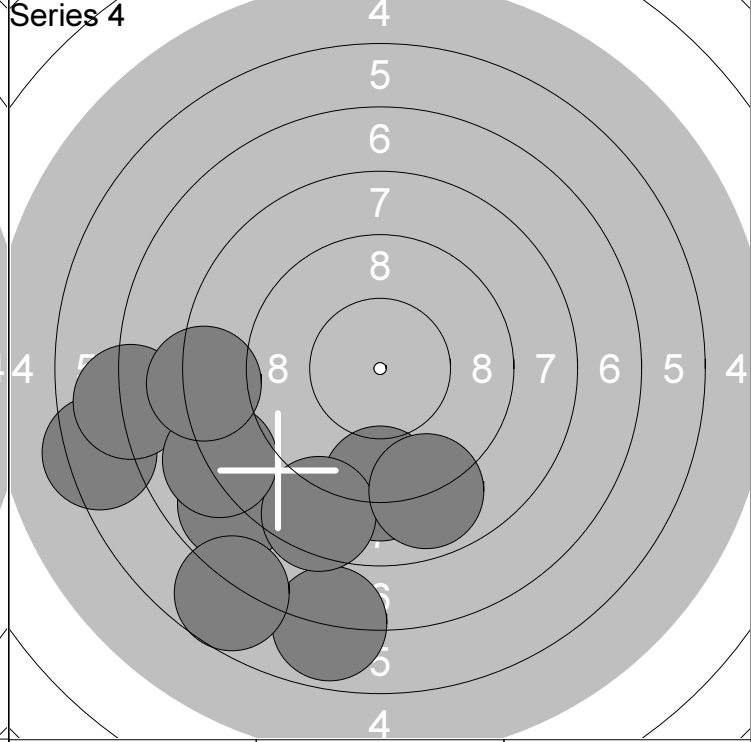
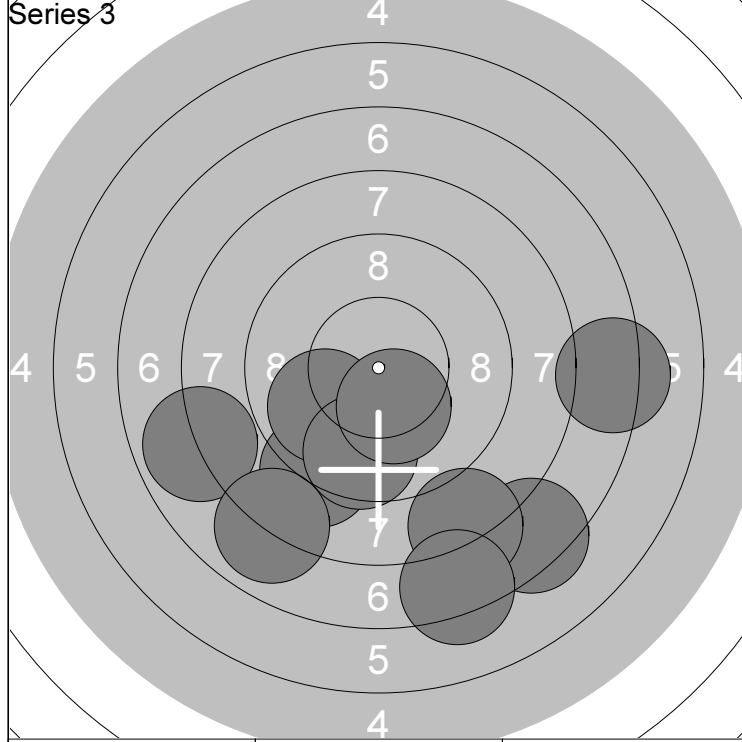

21: 7.3 →	26: 8.1 ↓	Series	81.0	31: 6.4 ←	36: 8.5 ↓	Series	73.0
22: 9.1 ↓	27: 9.9 ↙		Total	249.0	32: 7.8 ↙		37: 8.0 ↙
23: 7.9 ↙	28: 9.6 ↓	33: 7.0 ←		38: 8.9 ↓			
24: 8.0 ↓	29: *10.3 ↓	34: 6.9 ↓	39: 8.2 ↙				
25: 7.4 ↘	30: 7.3 ↓	35: 9.1 ↓	40: 6.7 ↓				

Relay <b>2</b>	Lane <b>4</b>	<b>Heikki Saarinen</b>			
-------------------	------------------	------------------------	--	--	--

Air	KaA	Y60	R
-----	-----	-----	---

09.-10.03.2013	Kevätkilpailu	Kankaanpään Ampumaurheilijat
----------------	---------------	------------------------------

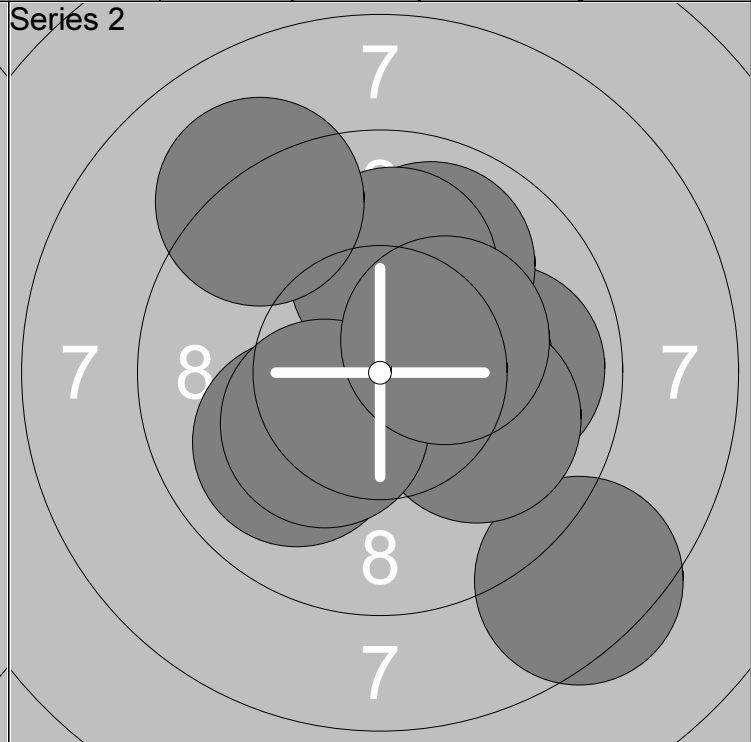
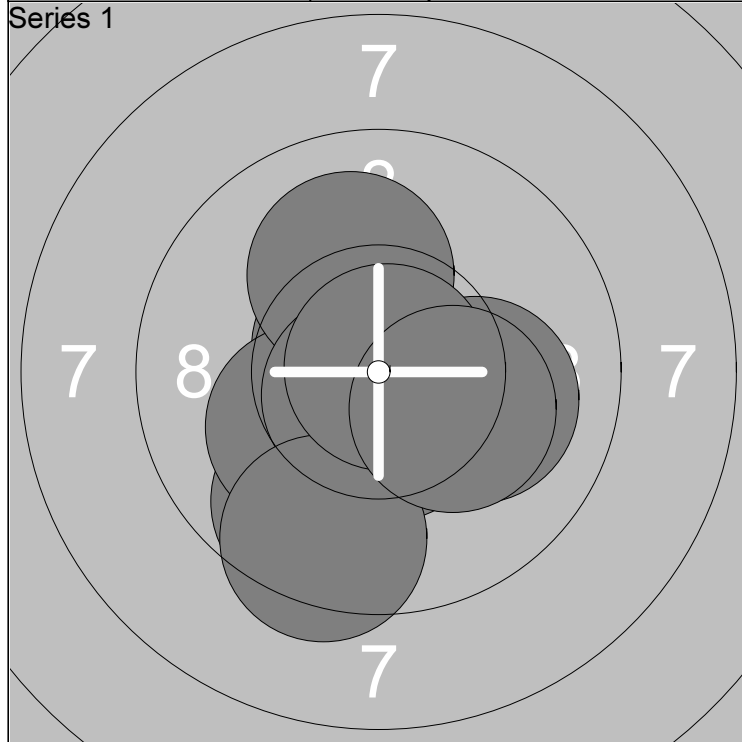

1: 9.7 ↘	6: *10.7 ↙	Series	98.0
2: *10.7 ↖	7: 10.1 →		
3: *10.2 ↙	8: 9.4 ↘	Total	98.0
4: *10.5 ↘	9: *10.9 ↗		
5: 10.1 ↑	10: *10.2 ↘		

11: 9.9 →	16: *10.3 →	Series	95.0
12: 8.5 ↘	17: 9.1 ↗		
13: 9.9 ↗	18: 10.0 →	Total	193.0
14: 10.0 ↙	19: *10.3 ↙		
15: 10.1 ↑	20: *10.3 ↗		

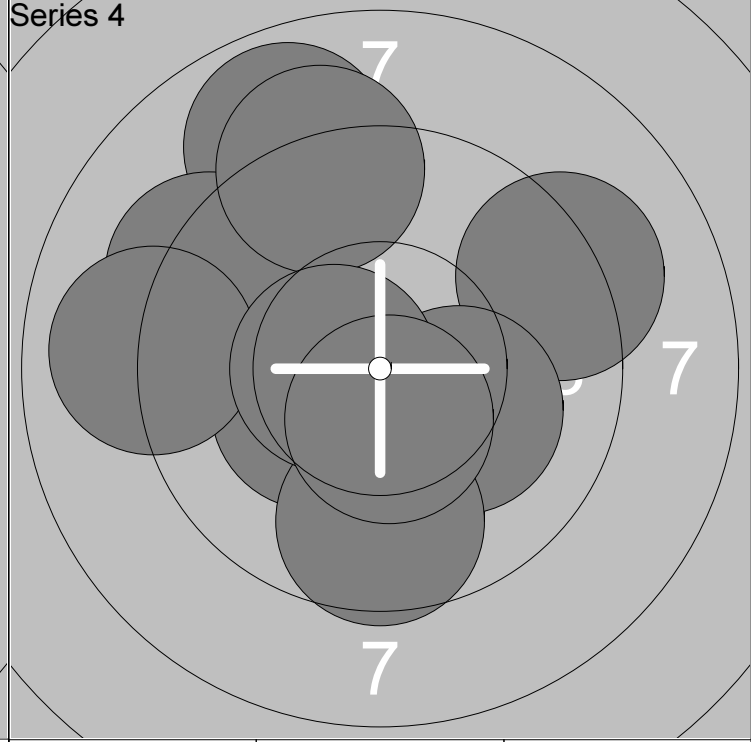
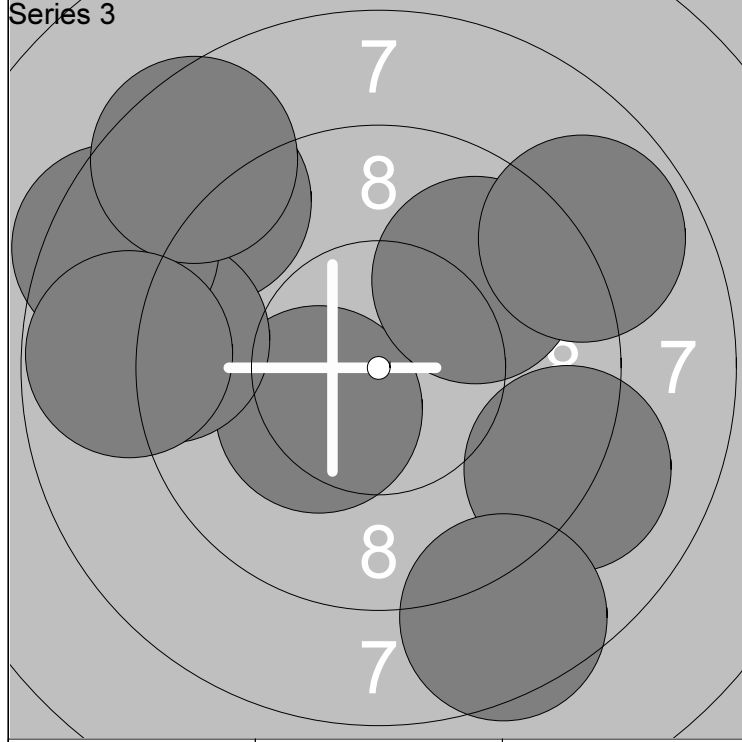

21: *10.3 ↙	26: 8.5 ↖	Series	85.0
22: 8.9 ↖	27: 9.8 ↗		
23: 9.1 →	28: 8.6 ↘	Total	278.0
24: 9.1 ←	29: 8.9 ↗		
25: 8.5 ←	30: 8.8 ←		

31: *10.3 ↙	36: 9.0 ←	Series	93.0
32: 8.9 ↗	37: *10.2 ↘		
33: 9.3 ↖	38: 9.6 ↘	Total	371.0
34: 9.2 ↗	39: *10.6 ←		
35: 9.2 ↑	40: *10.5 ↘		

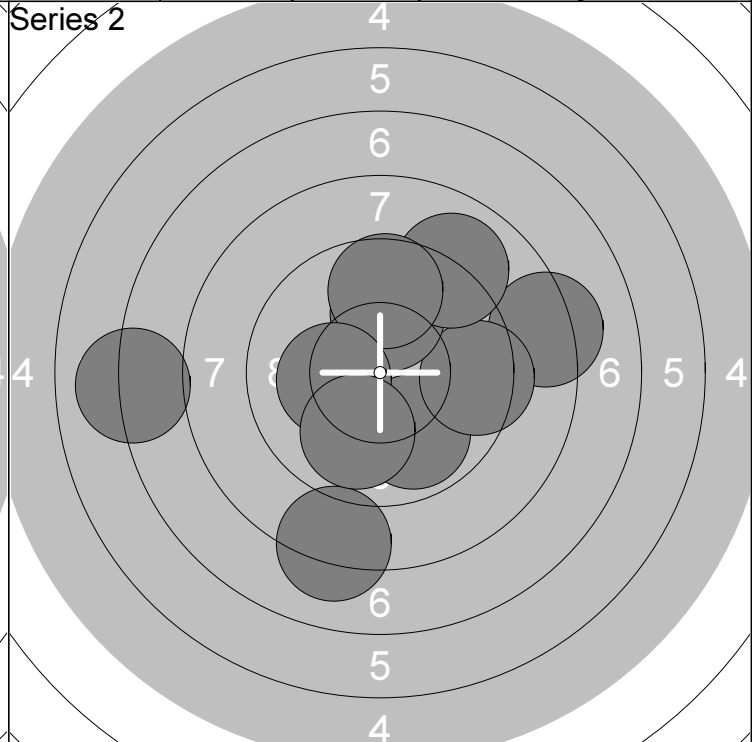
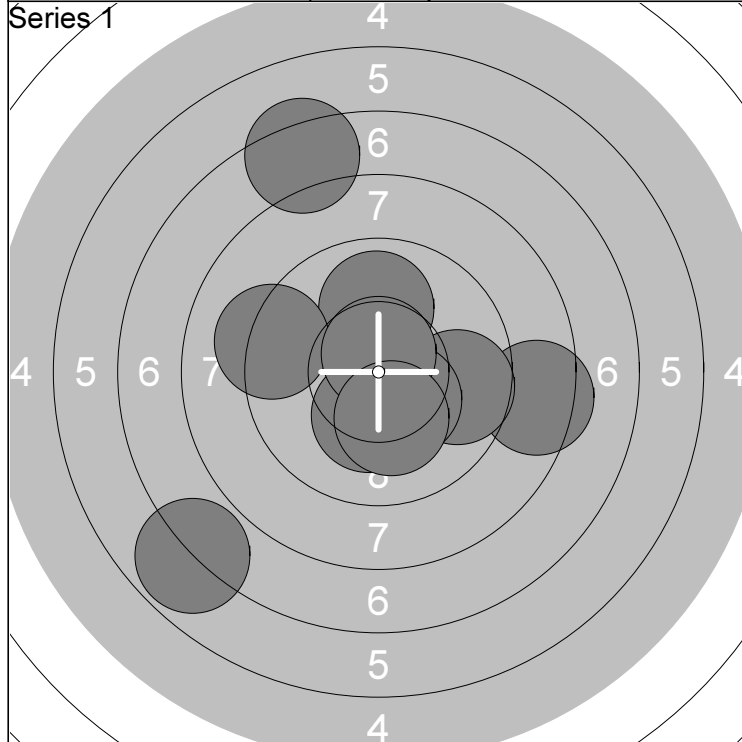

1: 8.4 →	6: *10.2 ↓	<b>Series</b>	89.0	11: 8.3 →	16: 7.1 ←	<b>Series</b>	89.0
2: 10.0 ↑	7: 7.3 ↗			12: 9.9 ↓	17: 9.0 ↗		
3: 9.7 →	8: 6.9 ↘	<b>Total</b>	89.0	13: 8.2 ↓	18: 9.7 ↑	<b>Total</b>	178.0
4: *10.3 ↓	9: *10.7 ↑			14: 9.4 →	19: *10.2 ←		
5: 9.2 ←	10: *10.2 ↓						

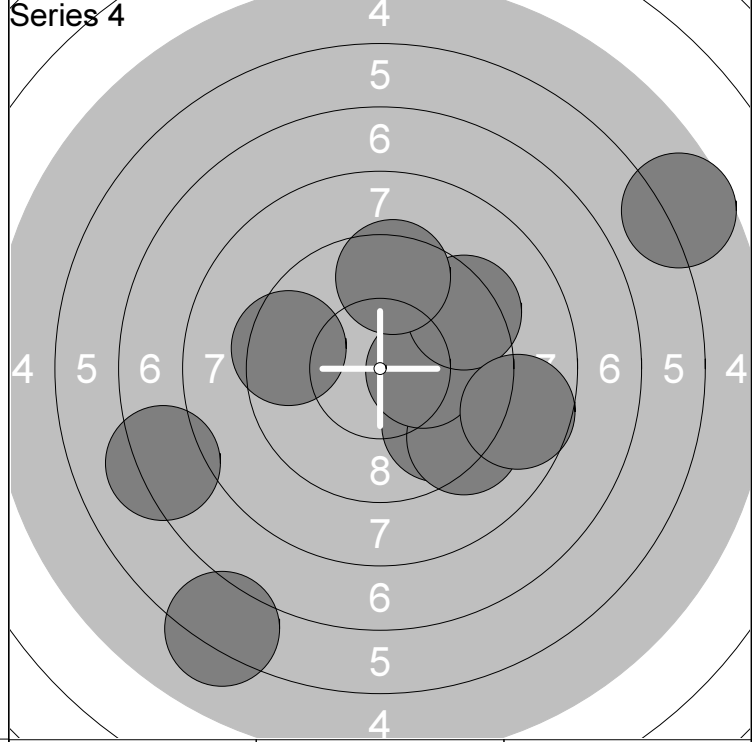
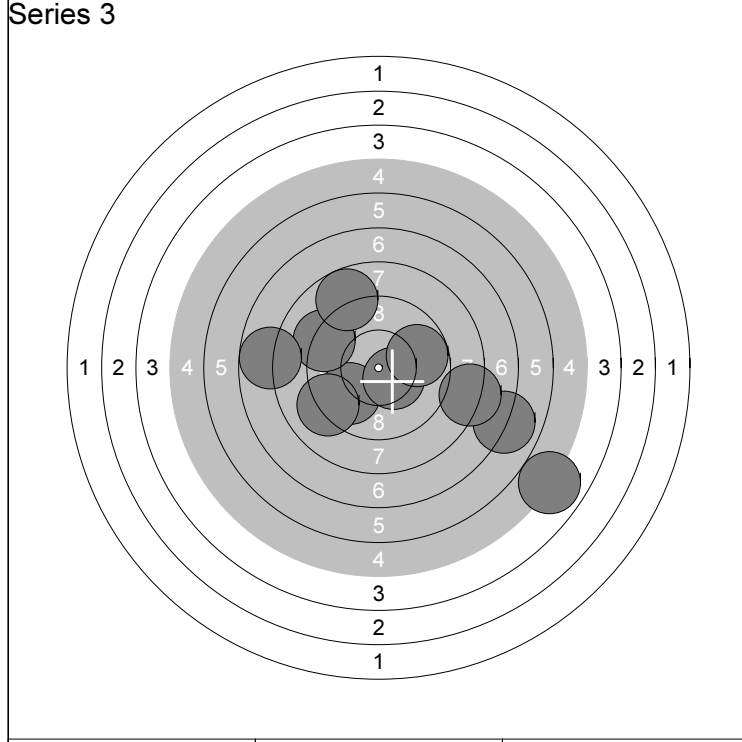

21: 6.9 →	26: *10.4 ↓	<b>Series</b>	79.0	31: 6.2 ↓	36: *10.3 →	<b>Series</b>	81.0
22: 9.8 ↘	27: 7.8 ←			32: 9.5 ←	37: 7.2 ←		
23: 8.2 →	28: 9.1 ↘	<b>Total</b>	257.0	33: 9.7 ↓	38: 9.4 ↗	<b>Total</b>	338.0
24: 9.2 ↖	29: 4.9 ↘			34: 9.2 ↘	39: 8.7 →		
25: 8.7 ↗	30: 9.8 →						

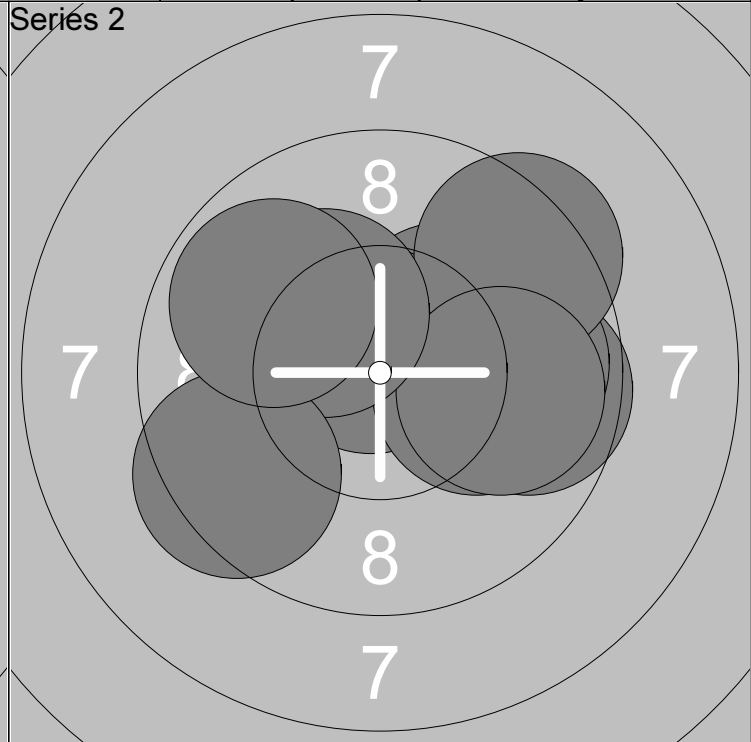
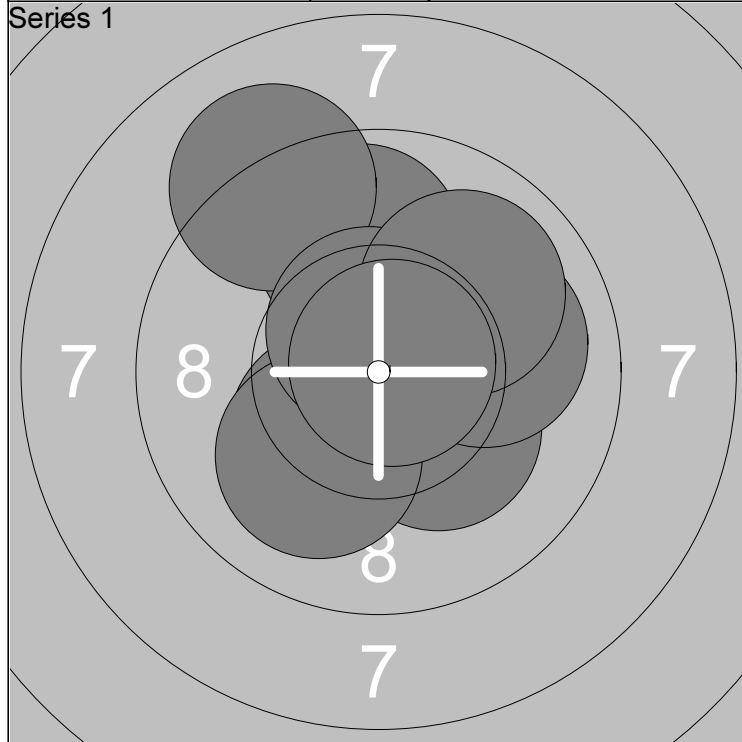

1: *10.5 ↗	6: 9.8 ↑	Series	97.0
2: *10.3 ↘	7: 9.1 ↗		
3: *10.2 ↘	8: *10.6 ↑	Total	97.0
4: 10.1 ↘	9: 9.9 ↗		
5: 10.0 →	10: *10.8 ↗		

11: *10.3 ↗	16: 9.4 ↗	Series	94.0
12: *10.8 ↗	17: 9.9 →		
13: 9.7 →	18: *10.3 ↘	Total	191.0
14: 10.1 →	19: 9.4 ↖		
15: 9.9 →	20: 9.9 ↖		

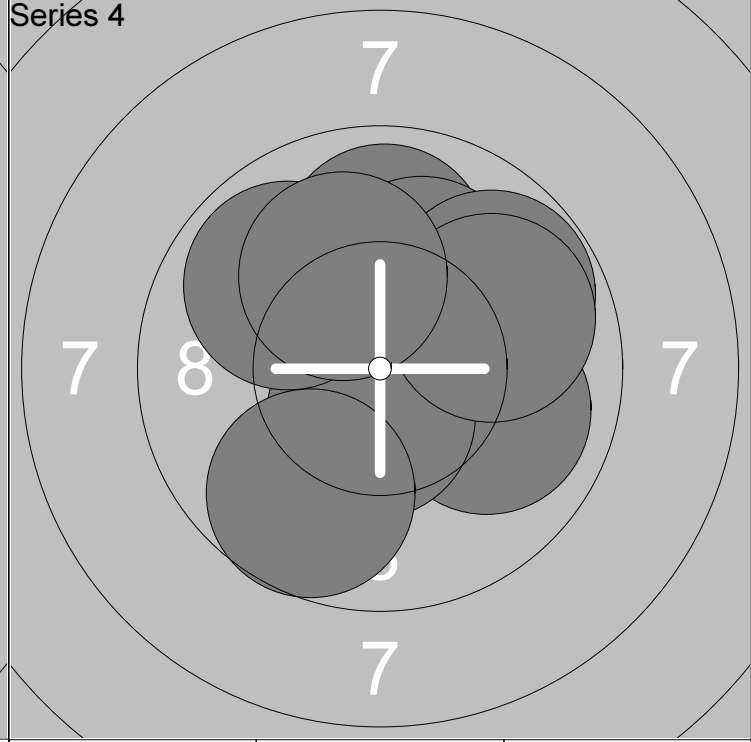
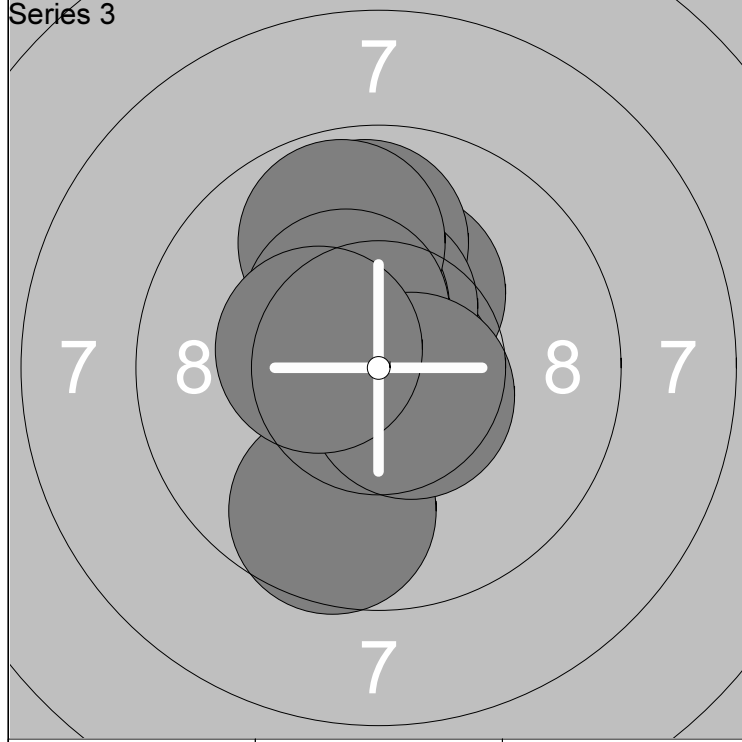

21: *10.3 ↑	26: *10.4 ↘	Series	97.0
22: 9.7 ↘	27: 9.8 ↑		
23: 9.9 ↑	28: *10.4 ↘	Total	288.0
24: *10.8 →	29: *10.6 ↘		
25: *10.4 ↑	30: *10.4 ↖		

31: 9.9 ↑	36: *10.5 ↘	Series	94.0
32: *10.6 ↘	37: 9.7 ↘		
33: 9.9 →	38: 9.9 →	Total	382.0
34: 10.1 ↑	39: 9.9 ↖		
35: 9.8 ↗	40: 10.1 ↑		

Relay <b>2</b>	Lane <b>7</b>	<b>Jenni Jussila</b>			
-------------------	------------------	----------------------	--	--	--

Air	RSA	N	R
-----	-----	---	---

09.-10.03.2013	Kevätkilpailu	Kankaanpään Ampumaurheilijat	
----------------	---------------	------------------------------	--

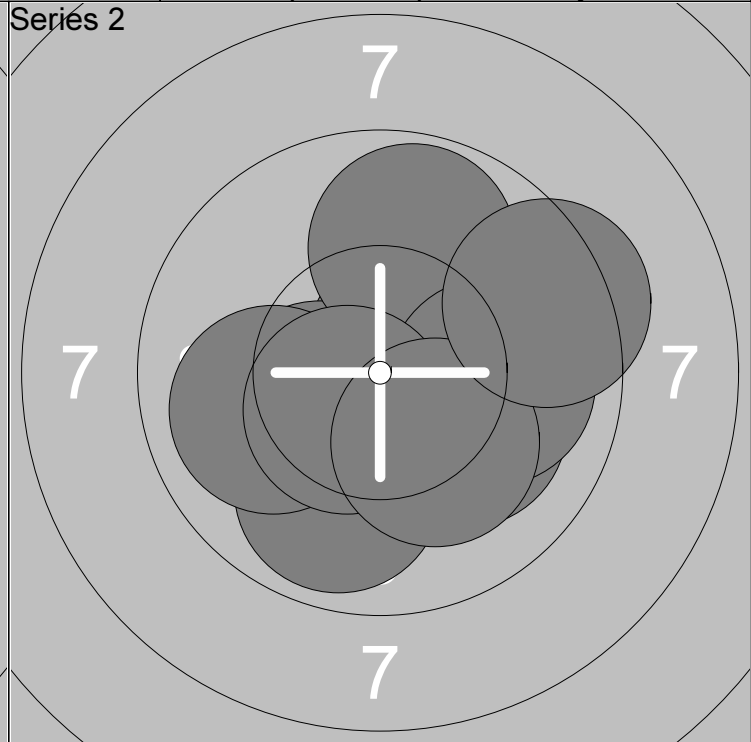
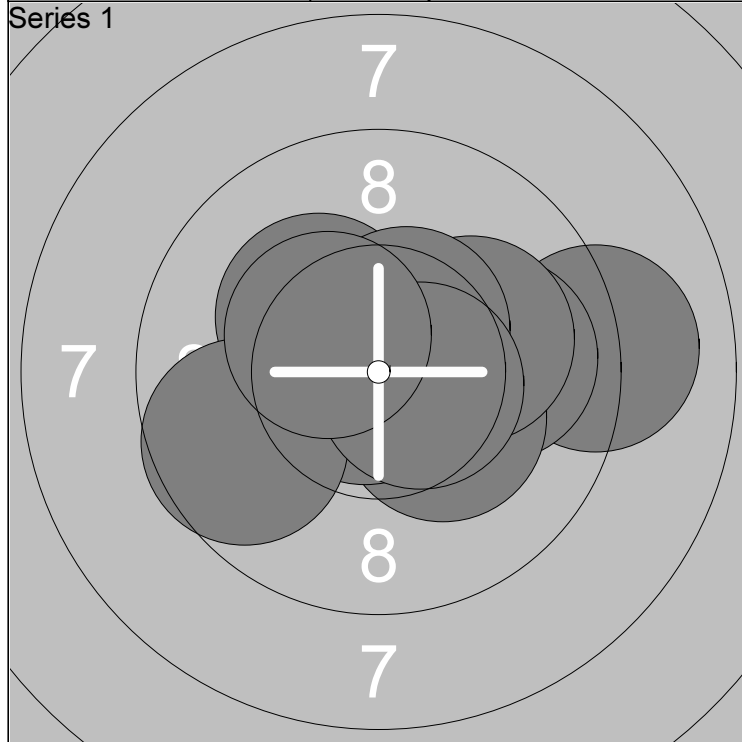

1: 9.1 →	6: *10.8 ↙	Series	97.0
2: 9.9 →	7: *10.5 ↗		
3: *10.2 ↘	8: 9.7 ←	Total	97.0
4: 10.1 →	9: *10.6 →		
5: *10.2 ↖	10: *10.4 ↖		

11: *10.6 ↗	16: 10.0 ←	Series	97.0
12: *10.4 ↙	17: 10.0 →		
13: 9.9 ↓	18: *10.5 ↙	Total	194.0
14: 10.1 →	19: *10.2 ↘		
15: 9.8 ↑	20: 9.4 →		

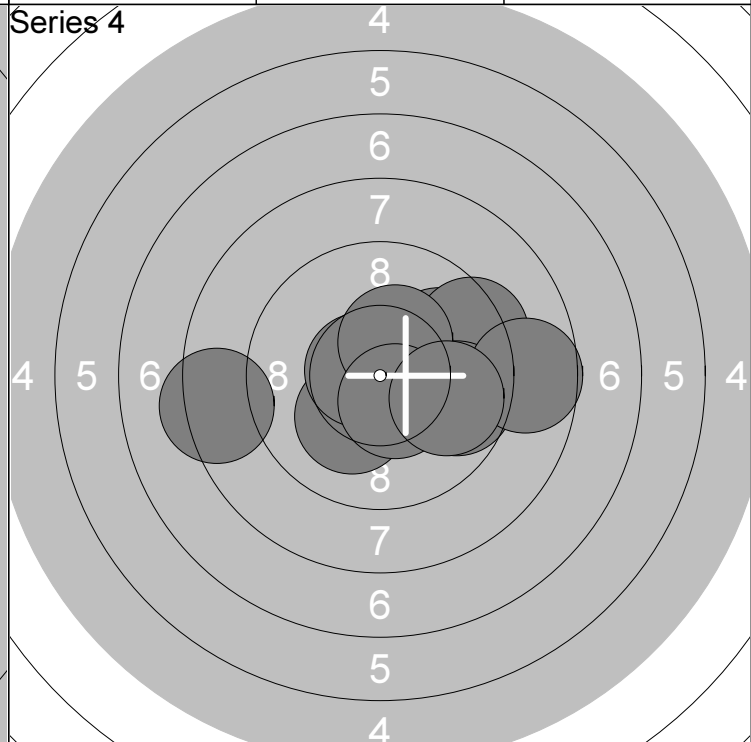
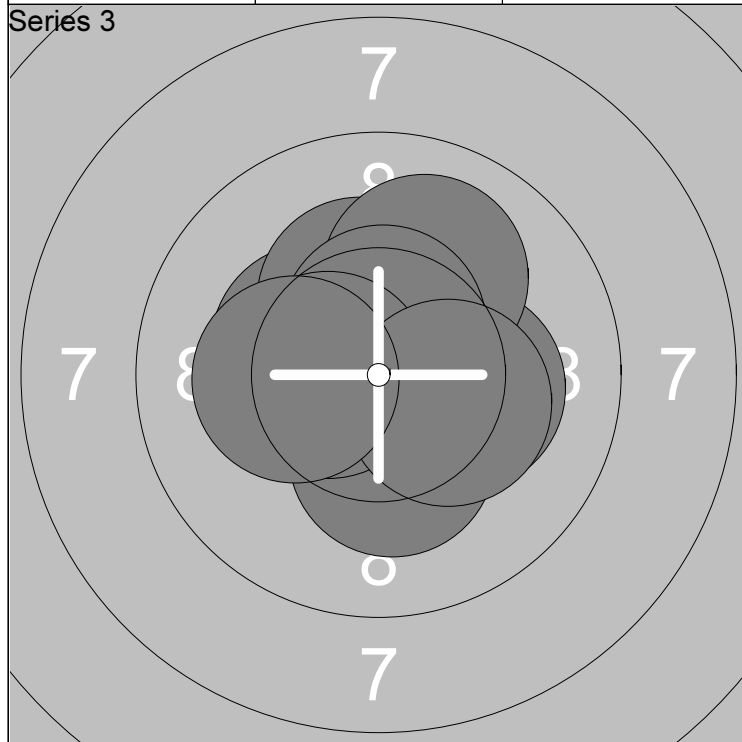

21: *10.3 ↖	26: *10.6 ↑	Series	100.0
22: *10.2 →	27: *10.3 ↓		
23: *10.3 ↑	28: *10.5 ←	Total	294.0
24: 10.0 ↗	29: *10.3 →		
25: *10.8 ↓	30: *10.2 ←		

31: 9.9 →	36: *10.6 ↖	Series	92.0
32: 9.4 →	37: 8.4 ←		
33: 9.7 →	38: *10.4 ↗	Total	386.0
34: *10.2 ↙	39: *10.5 ↓		
35: 8.7 →	40: 9.8 →		

Relay <b>2</b>	Lane <b>8</b>	<b>Jenni Leppänen</b>			
-------------------	------------------	-----------------------	--	--	--

Air	V-SA	N	R
-----	------	---	---

09.-10.03.2013	Kevätkilpailu	Kankaanpään Ampumaurheilijat	
----------------	---------------	------------------------------	--

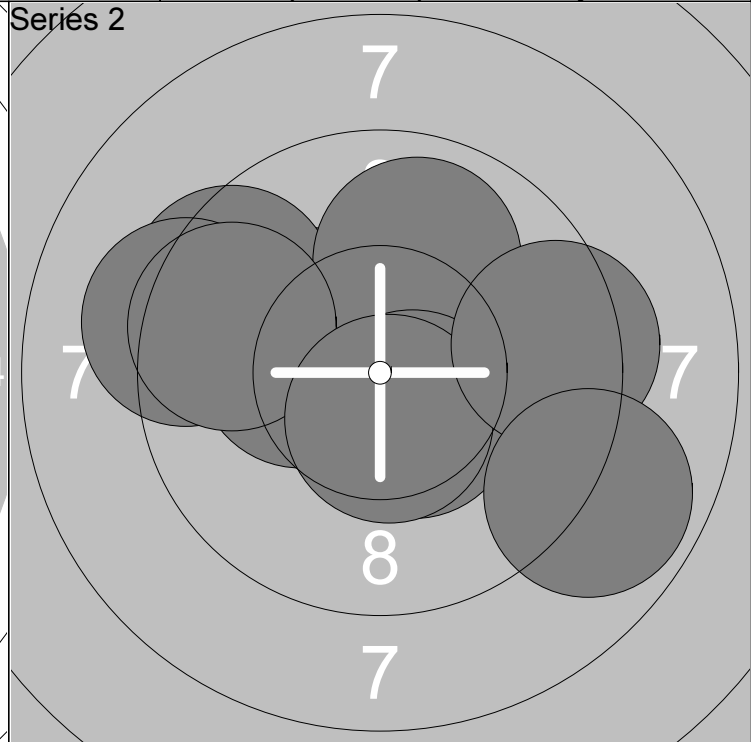
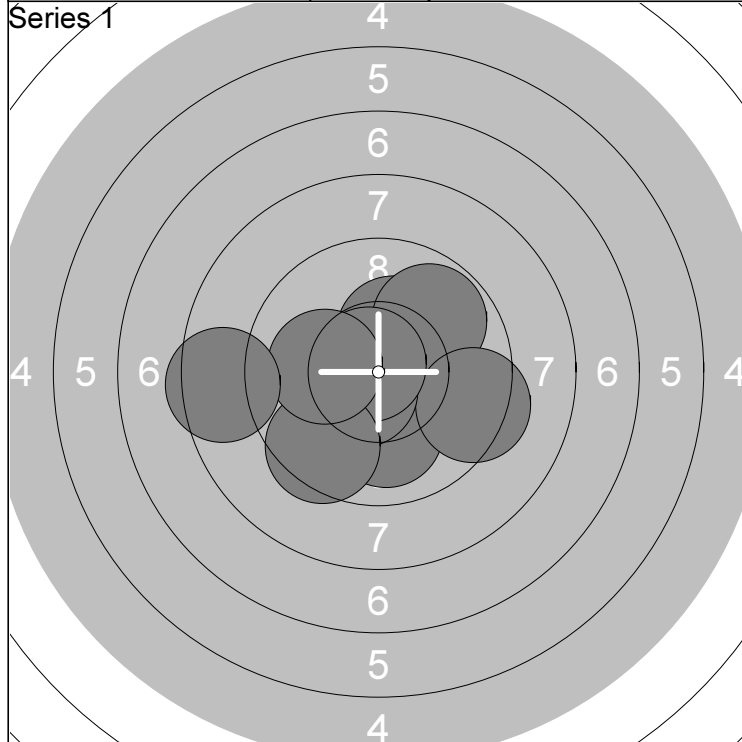

1: *10.3 ↗	6: *10.3 ←	Series	95.0
2: 9.8 ↗	7: *10.7 ↘		
3: 10.0 ↓	8: 9.5 ↓	Total	95.0
4: 9.4 →	9: 10.1 ←		
5: *10.6 ↘	10: 8.5 ←		

11: *10.2 ↘	16: *10.5 ↘	Series	93.0
12: 9.5 ↘	17: 9.6 ←		
13: *10.3 ←	18: *10.6 ↓	Total	188.0
14: 9.2 ←	19: 9.4 →		
15: 9.9 ↗	20: 8.9 ↘		

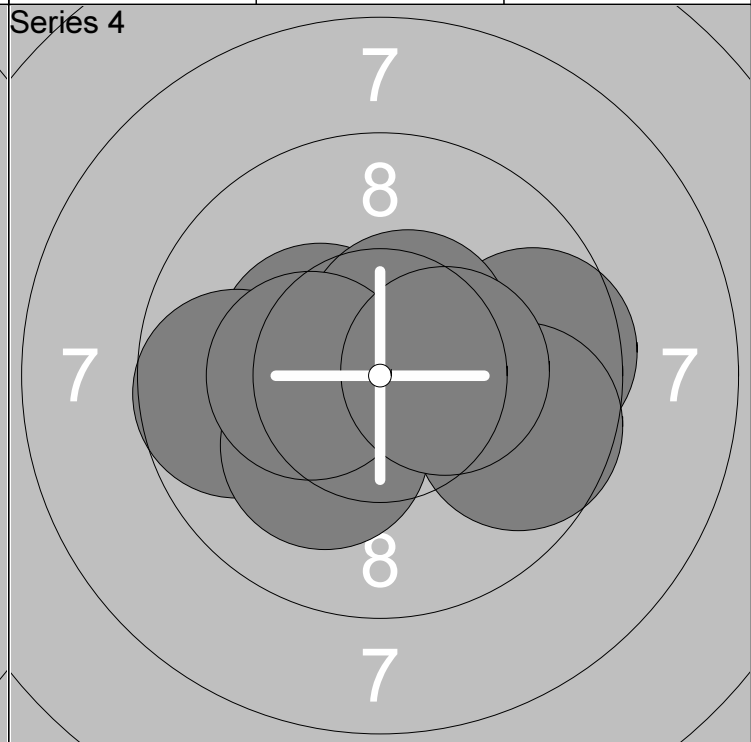
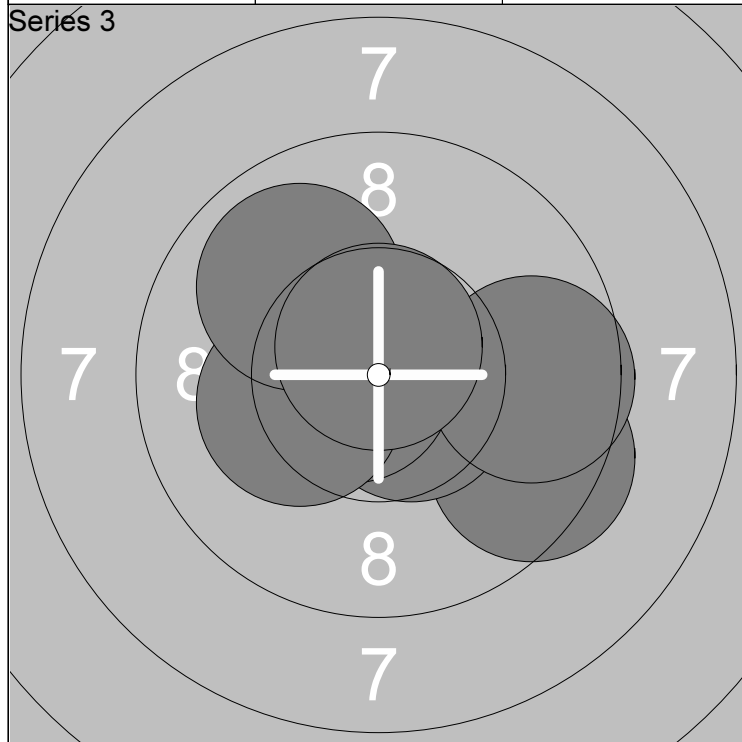

21: 9.4 →	26: *10.7 ←	Series	97.0
22: *10.6 ↘	27: *10.2 ←		
23: *10.4 ↘	28: 9.9 ↗	Total	285.0
24: *10.6 ←	29: 9.6 →		
25: *10.4 ↘	30: *10.7 ↗		

31: *10.3 ←	36: *10.2 ↘	Series	97.0
32: *10.6 ↘	37: *10.5 ↗		
33: *10.4 ↘	38: 9.7 →	Total	382.0
34: 9.7 ←	39: *10.4 ←		
35: 9.6 →	40: *10.4 →		

Relay <b>2</b>	Lane <b>9</b>	<b>Saana Tattari</b>		
-------------------	------------------	----------------------	--	--

Air	NoSA	N18	R
-----	------	-----	---

09.-10.03.2013	Kevätkilpailu	Kankaanpään Ampumaurheilijat	
----------------	---------------	------------------------------	--

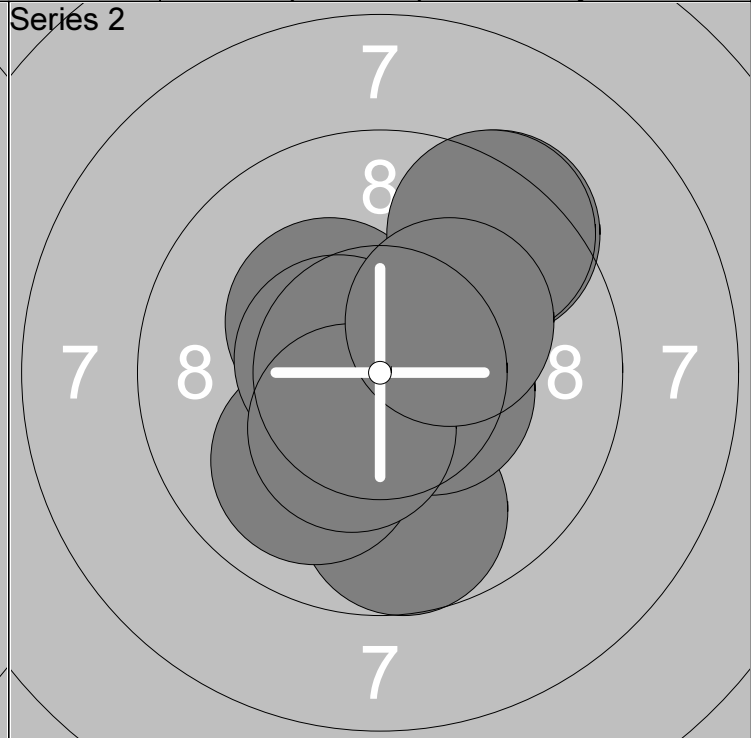
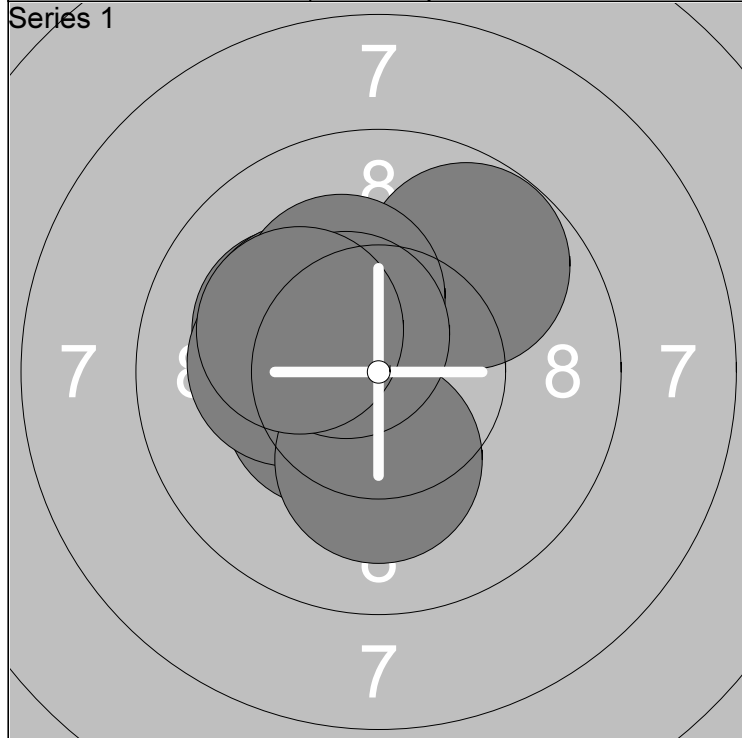

1: *10.2 ↘	6: *10.2 ↓	Series	99.0
2: *10.4 ↙	7: *10.2 ↘		Total
3: *10.6 ↘	8: *10.3 ↗		
4: *10.2 ↙	9: *10.5 ↗		
5: 9.8 ↗	10: *10.2 ↘		

11: *10.6 ↘	16: 9.4 ↗	Series	97.0
12: 9.7 ↓	17: *10.6 ↘		Total
13: 9.4 ↗	18: *10.5 →		
14: 10.0 ↙	19: *10.4 ↓		
15: *10.3 ↘	20: *10.2 ↗		

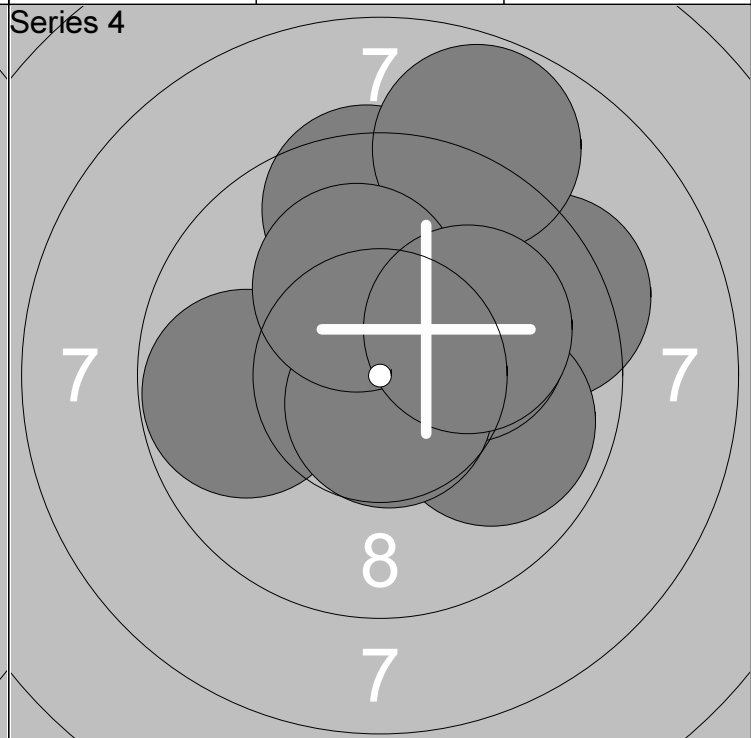
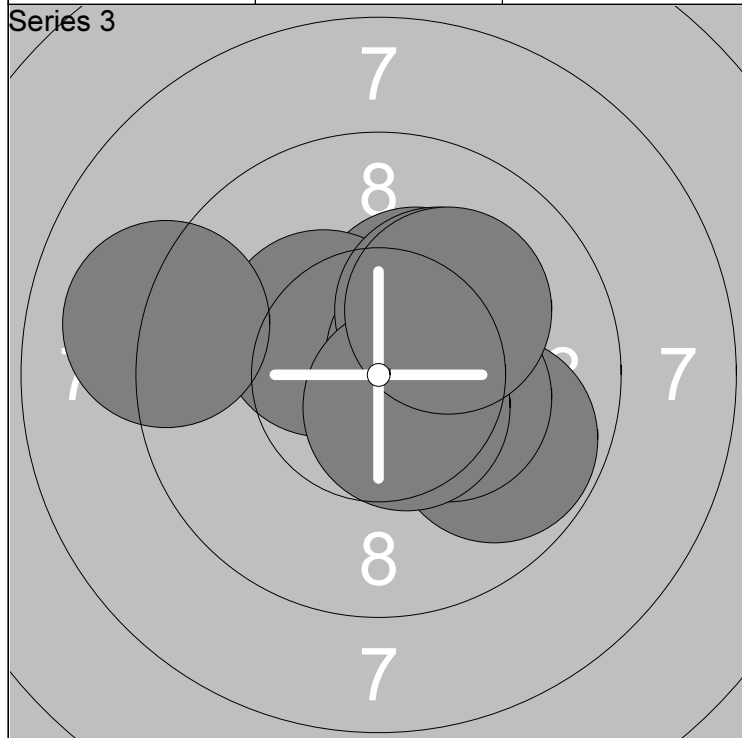

21: *10.6 ↑	26: *10.3 →	Series	98.0
22: *10.3 ↗	27: 9.1 ←		Total
23: *10.3 ↘	28: *10.2 ↗		
24: 9.8 →	29: *10.6 ↓		
25: *10.5 →	30: 10.1 ↗		

31: 9.6 ↗	36: 8.8 ↗	Series	93.0
32: 9.8 ←	37: *10.2 →		Total
33: 9.4 ↗	38: *10.7 ↓		
34: 9.5 ↑	39: 10.1 ↑		
35: 9.9 →	40: 10.1 →		



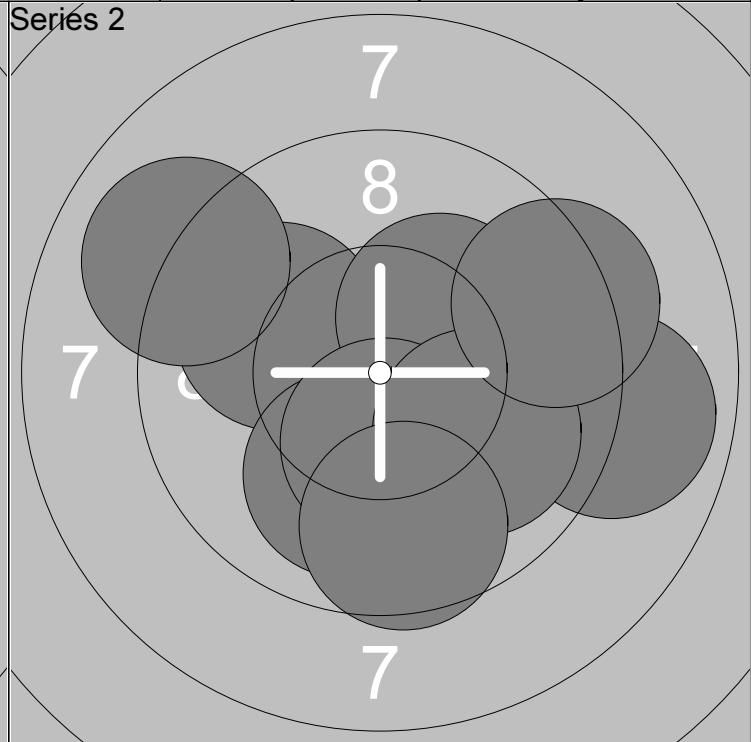
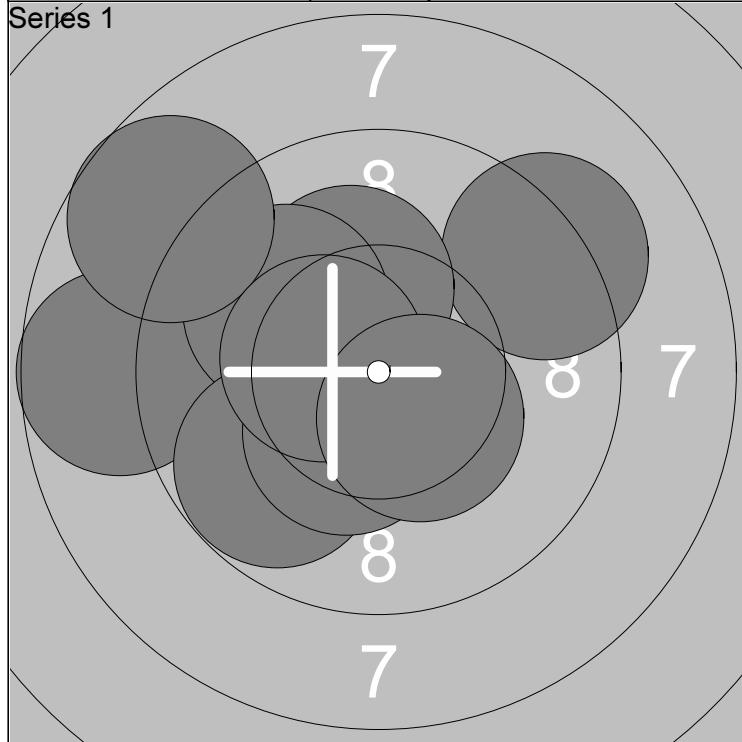

1: *10.2 ↘	6: 9.8 ↙	Series	94.0
2: 9.2 ↗	7: 8.7 ↖		
3: *10.2 ↗	8: *10.4 ↓	Total	94.0
4: 8.7 ←	9: *10.5 ↙		
5: 10.0 ↖	10: *10.4 ↓		

11: 9.9 ↓	16: 10.0 ↓	Series	94.0
12: 8.9 →	17: *10.4 ↓		
13: 10.0 ↖	18: 10.0 ↘	Total	188.0
14: *10.2 ↗	19: 9.6 ↓		
15: 9.0 ↖	20: 9.3 →		

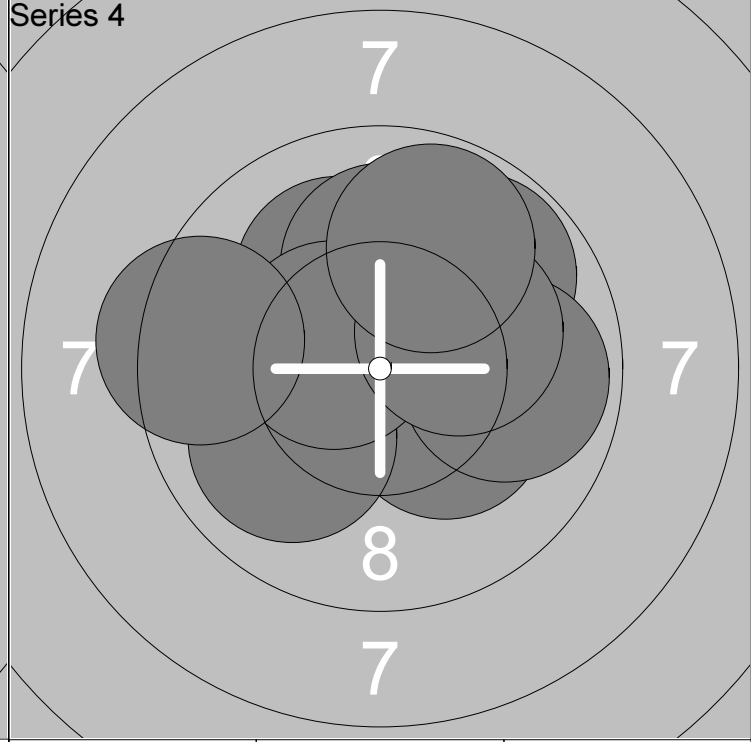
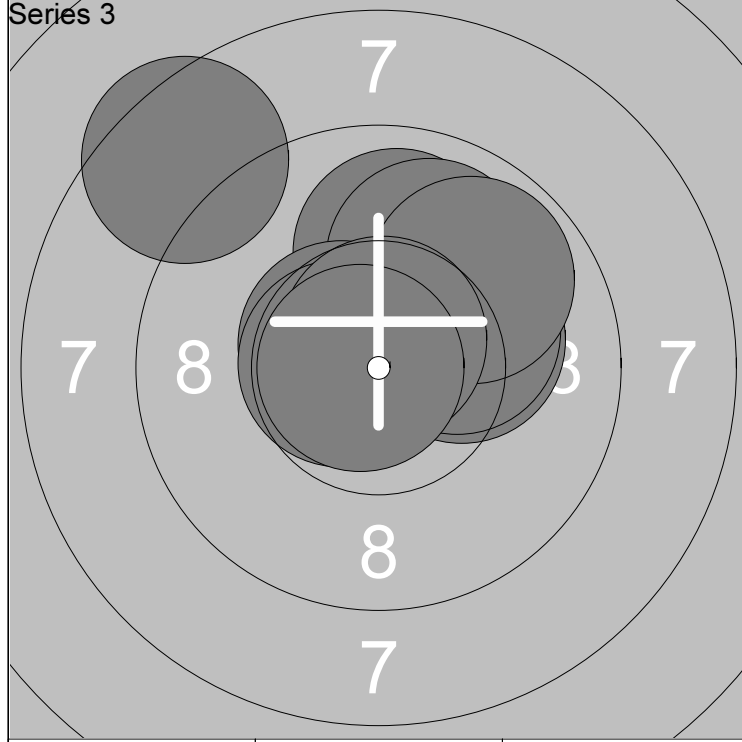

21: 9.9 ↑	26: *10.6 ↘	Series	95.0
22: *10.2 →	27: *10.6 ↙		
23: 9.9 ↑	28: *10.7 ↑	Total	283.0
24: *10.2 →	29: 8.5 ↖		
25: 9.8 ↗	30: *10.8 ↙		

31: *10.3 ↘	36: *10.5 ↙	Series	96.0
32: 10.1 ↖	37: 9.4 ←		
33: 10.0 ↙	38: 9.9 →	Total	379.0
34: 10.0 ↑	39: *10.2 →		
35: 9.8 ↗	40: 9.8 ↑		

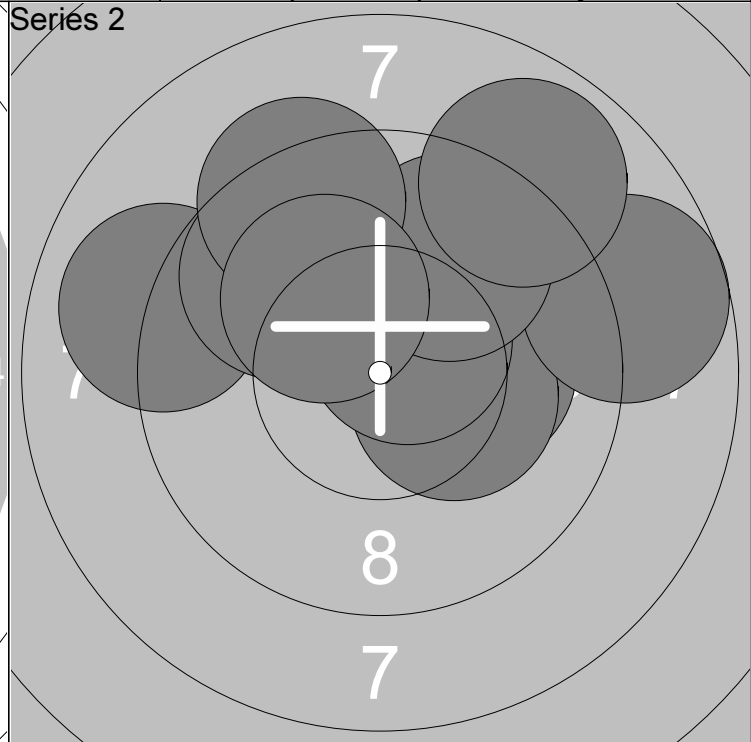
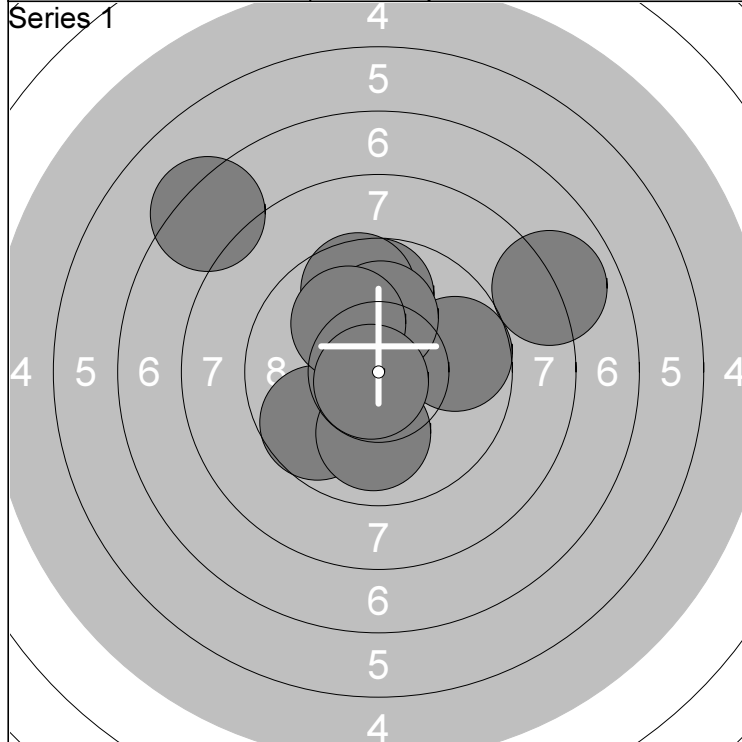

1: 9.7 ↙	6: 9.7 →	Series	91.0
2: 10.0 ↓	7: 10.1 ↑		
3: 9.7 ↑	8: 10.0 ↖	Total	91.0
4: 9.6 ↑	9: 8.0 ↗		
5: 7.3 ↖	10: *10.8 ↘		

11: *10.2 →	16: *10.6 ↗	Series	92.0
12: 9.0 ←	17: 9.8 ↗		
13: *10.3 →	18: 9.3 ↖	Total	183.0
14: 9.8 ↖	19: 8.9 ↗		
15: 8.7 →	20: *10.2 ↘		

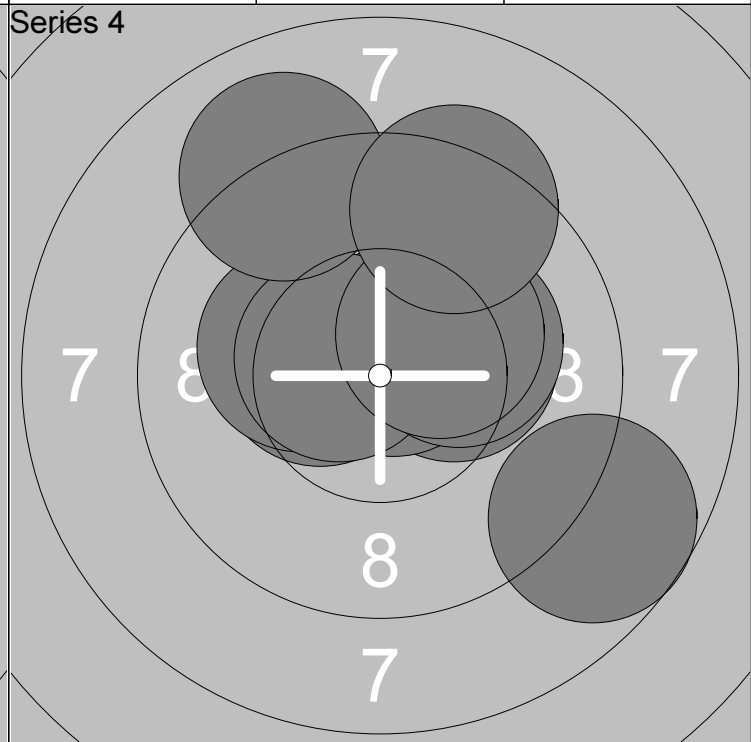
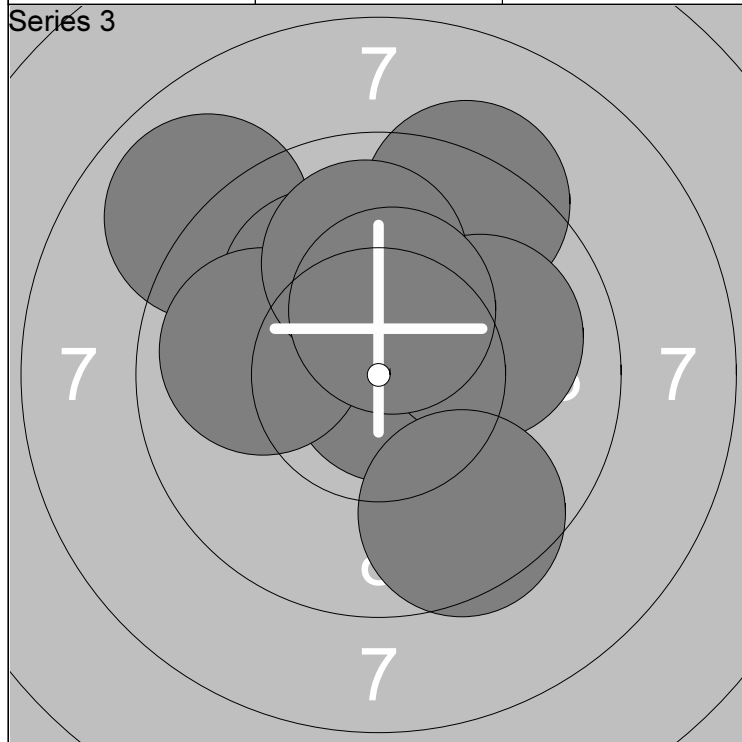

21: *10.7 ↗	26: 10.0 →	Series	95.0
22: 8.9 ↖	27: 9.9 ←		
23: 10.1 ↖	28: 9.6 ↓	Total	278.0
24: *10.8 →	29: 10.0 ↑		
25: 9.3 ↑	30: *10.4 ↑		

31: *10.3 →	36: *10.6 ↖	Series	96.0
32: *10.7 ↗	37: *10.2 →		
33: *10.4 ↖	38: 9.0 ↖	Total	374.0
34: *10.2 ↖	39: *10.3 ↗		
35: 8.7 ↘	40: 9.4 ↑		

Relay <b>2</b>	Lane <b>12</b>	<b>Roosa Prusila</b>			
-------------------	-------------------	----------------------	--	--	--

Air	NoSA	N18	R
-----	------	-----	---

09.-10.03.2013	Kevätkilpailu	Kankaanpään Ampumaurheilijat
----------------	---------------	------------------------------

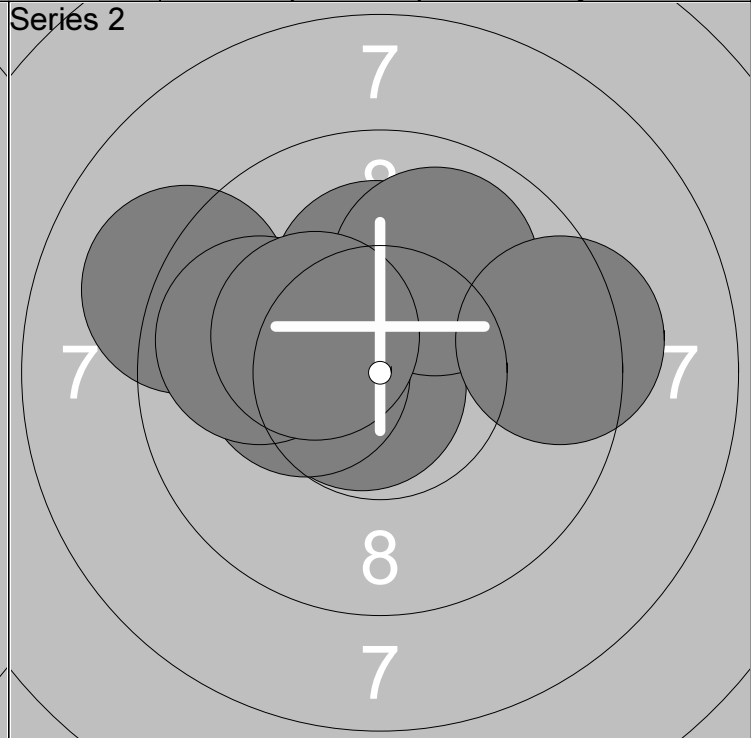
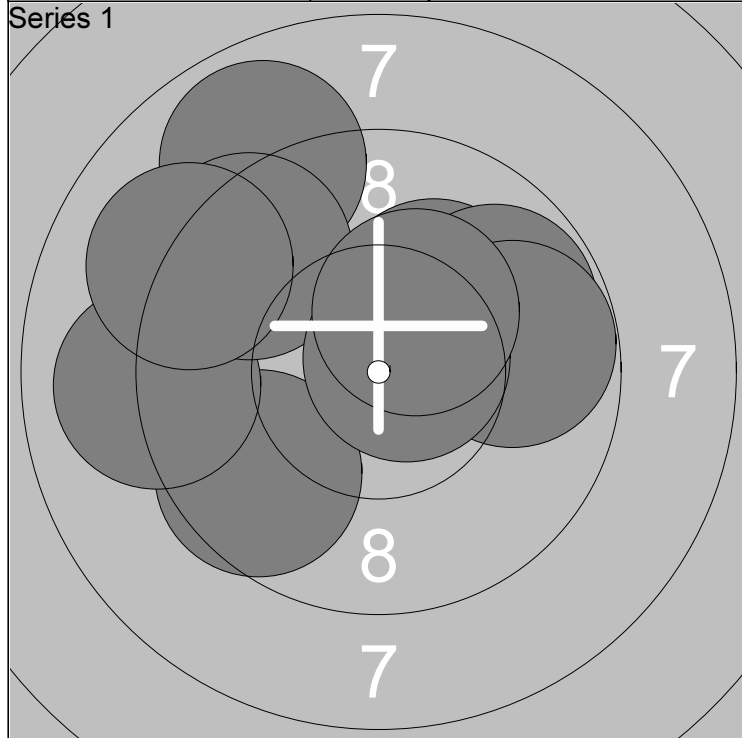

1: 8.9 ↗	6: 9.4 ↗	Series	92.0
2: 9.6 ↘	7: 9.1 ↖		
3: *10.2 ↗	8: 9.8 →	Total	92.0
4: 9.8 ↗	9: *10.7 ↗		
5: 9.0 ←	10: *10.3 ↗		

11: *10.3 ↑	16: *10.3 ↖	Series	96.0
12: *10.2 ↑	17: 9.9 ↗		
13: 9.1 ↖	18: 9.4 →	Total	188.0
14: *10.4 ↖	19: 9.9 ↖		
15: *10.7 ↘	20: *10.3 ↖		

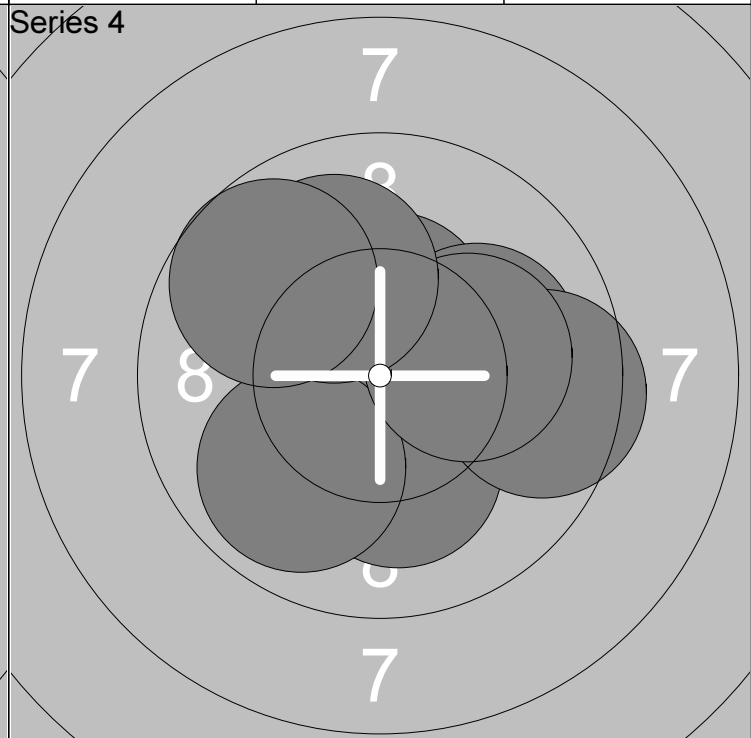
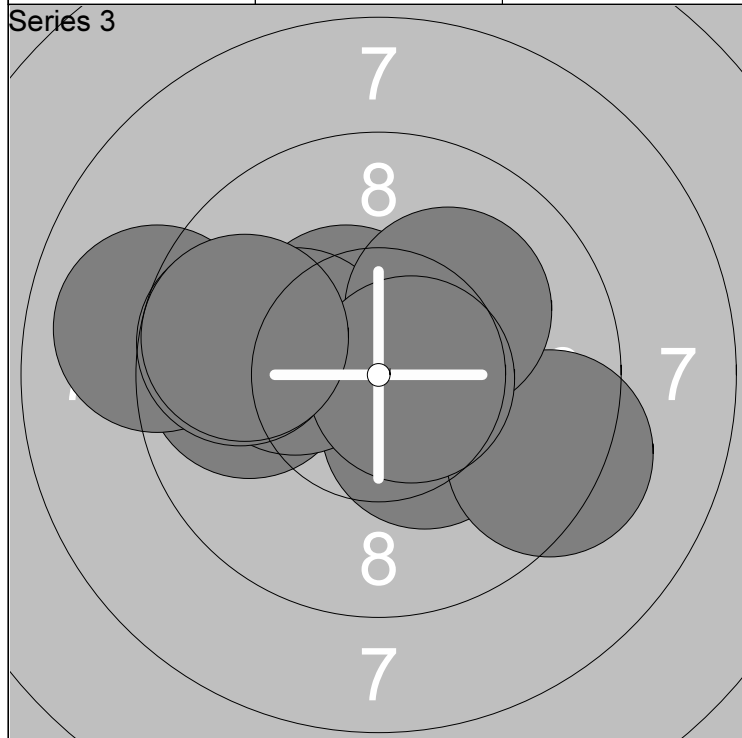

21: *10.4 ↘	26: 9.3 →	Series	95.0
22: *10.5 ↗	27: 9.7 ↖		
23: 9.8 ←	28: 10.1 ↗	Total	283.0
24: 9.0 ←	29: *10.7 ↗		
25: *10.2 ↖	30: 9.7 ↖		

31: *10.6 ↑	36: 9.9 ↘	Series	97.0
32: *10.4 ↑	37: 9.6 →		
33: 10.1 →	38: *10.2 →	Total	380.0
34: *10.4 ↘	39: 10.0 ↗		
35: *10.2 ↘	40: 9.7 ↖		

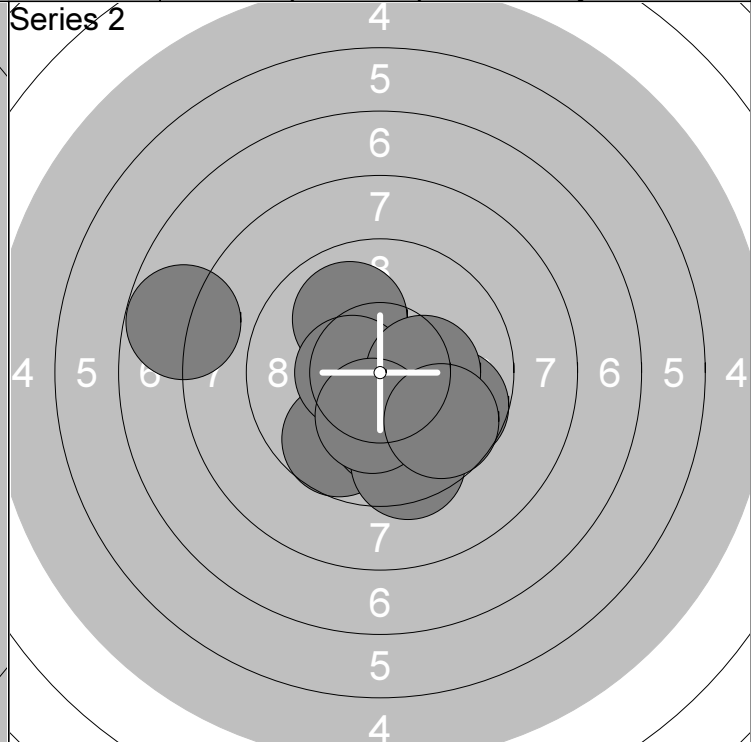
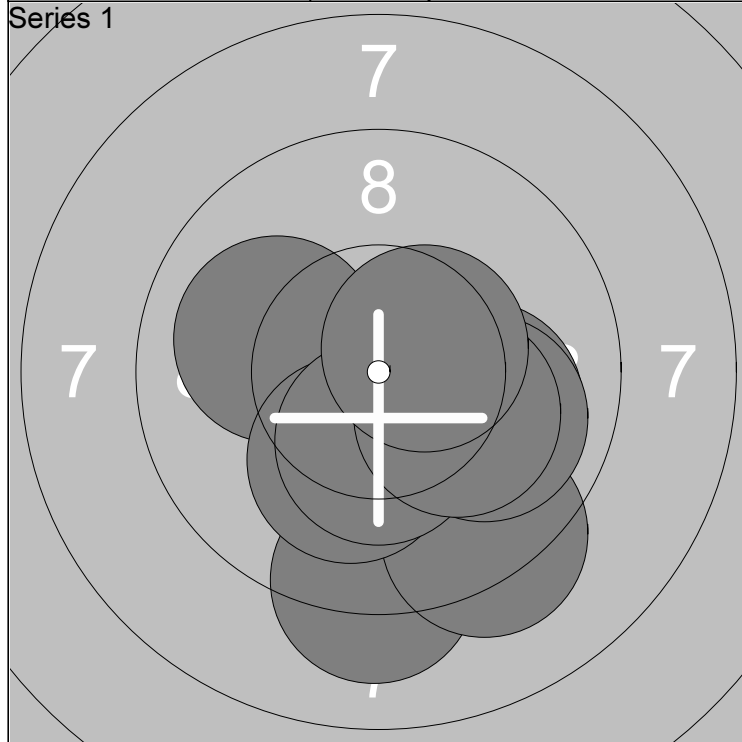

1: 10.0 →	6: 10.0 ←	Series	97.0
2: *10.4 →	7: *10.2 ↓		
3: 9.1 ↓	8: *10.3 ↓	Total	97.0
4: 9.3 ↓	9: *10.2 →		
5: 9.9 →	10: *10.5 →		

11: 9.7 →	16: 9.5 ↓	Series	93.0
12: 9.7 ↓	17: *10.5 ←		
13: 7.8 ←	18: *10.3 →	Total	190.0
14: 10.1 ↓	19: *10.3 ↓		
15: 10.0 ↗	20: 9.7 ↘		

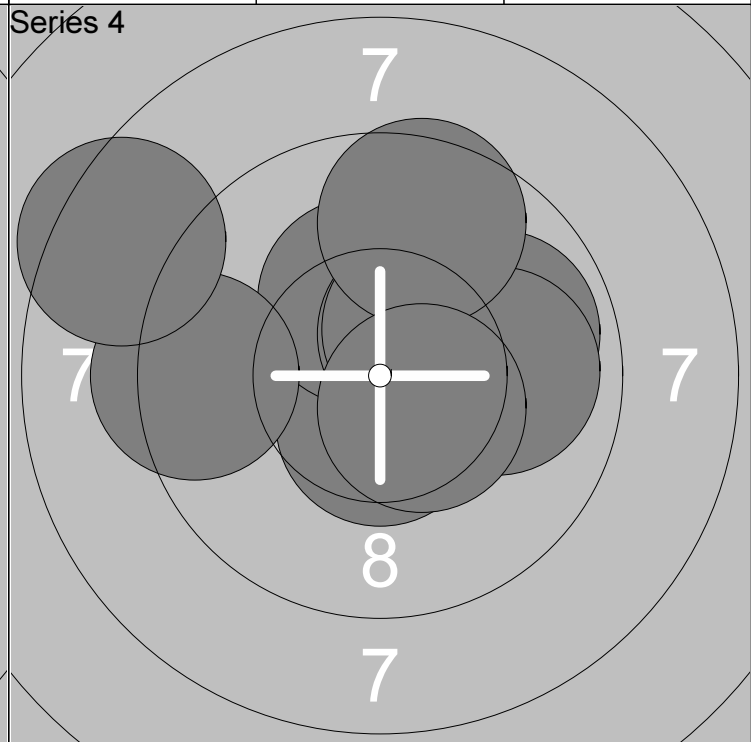
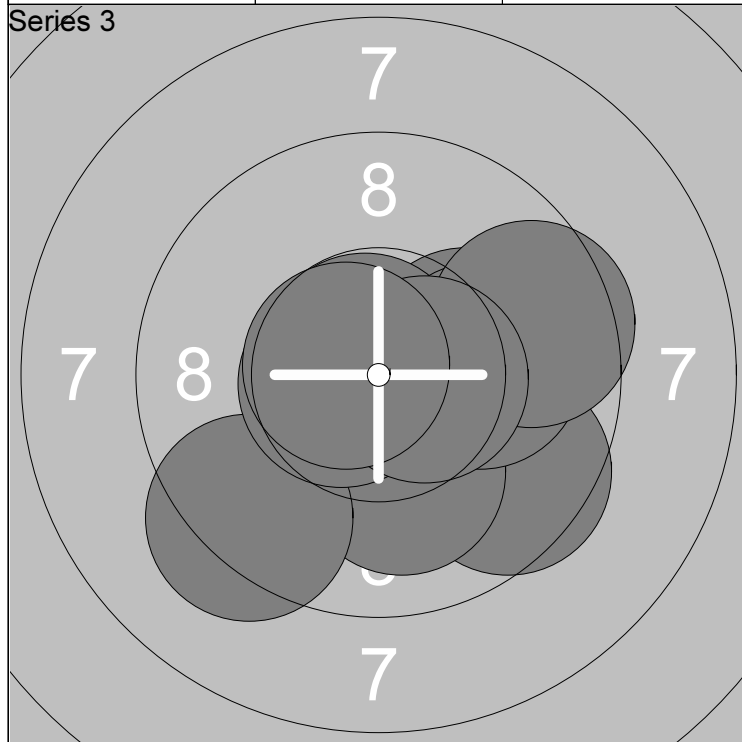

21: *10.2 →	26: 9.3 ↙	Series	97.0
22: 9.6 ↘	27: *10.6 ←		
23: *10.8 ↖	28: 9.6 →	Total	287.0
24: 10.1 ↓	29: *10.6 →		
25: 10.1 →	30: *10.7 ←		

31: *10.5 ↓	36: *10.5 ↗	Series	94.0
32: 9.9 →	37: *10.4 ↗		
33: *10.3 ↗	38: 9.9 →	Total	381.0
34: 9.4 ←	39: 9.6 ↗		
35: 8.4 ←	40: *10.5 ↘		

Relay <b>2</b>	Lane <b>14</b>	<b>Katariina Laine</b>		
-------------------	-------------------	------------------------	--	--

Air	HIAS	N18	R
-----	------	-----	---

09.-10.03.2013	Kevätkilpailu	Kankaanpään Ampumaurheilijat	
----------------	---------------	------------------------------	--

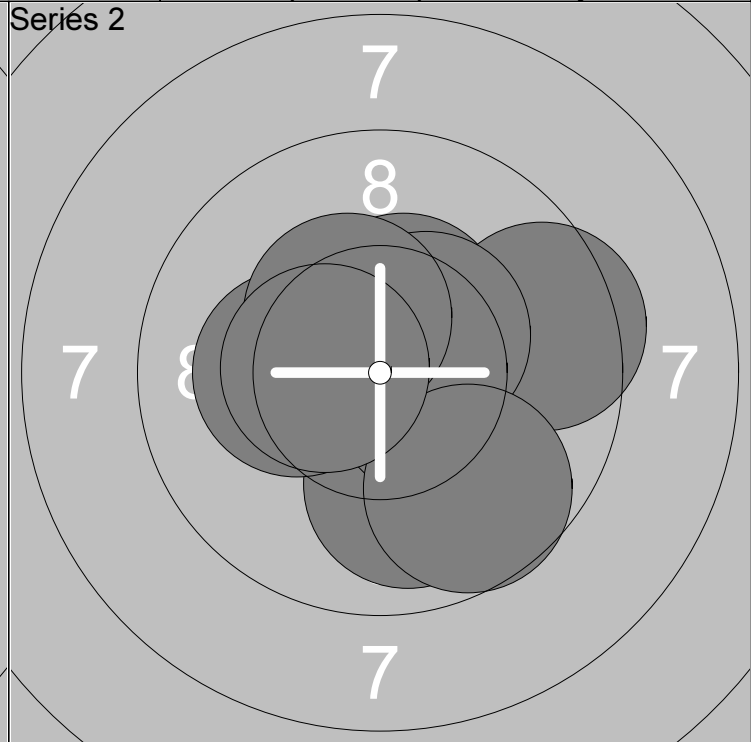
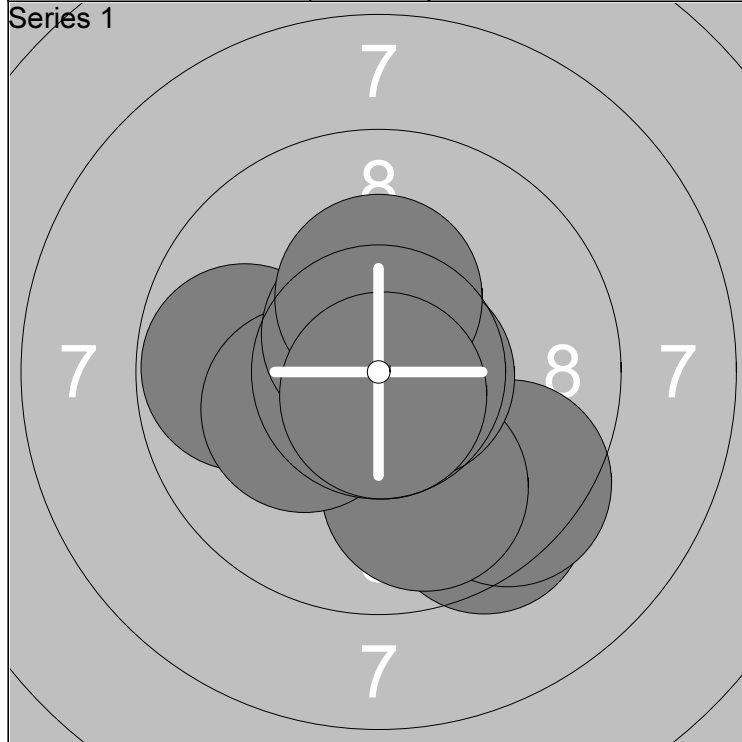

1: *10.7↓	6: *10.7→	Series	96.0
2: 9.4 ↓	7: *10.3↙		
3: 9.5 ↓	8: *10.6↗	Total	96.0
4: 9.9 ↓	9: *10.3↑		
5: 9.8 ←	10: *10.7↓		

11: *10.7↗	16: 9.5 →	Series	98.0
12: 10.0 ↓	17: *10.4↗		
13: *10.4→	18: 9.7 ↓	Total	194.0
14: *10.4↑	19: *10.4↖		
15: *10.2↙	20: *10.5↙		

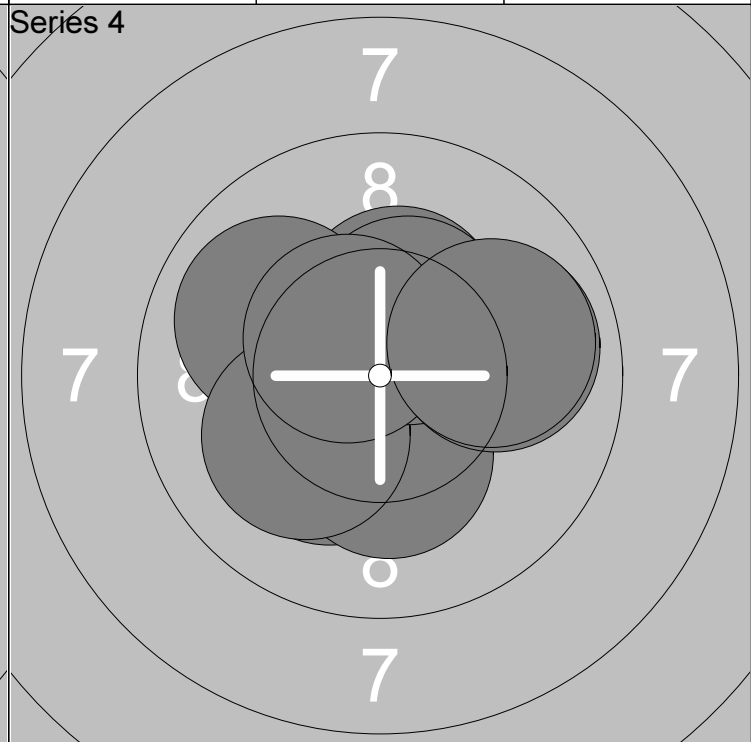
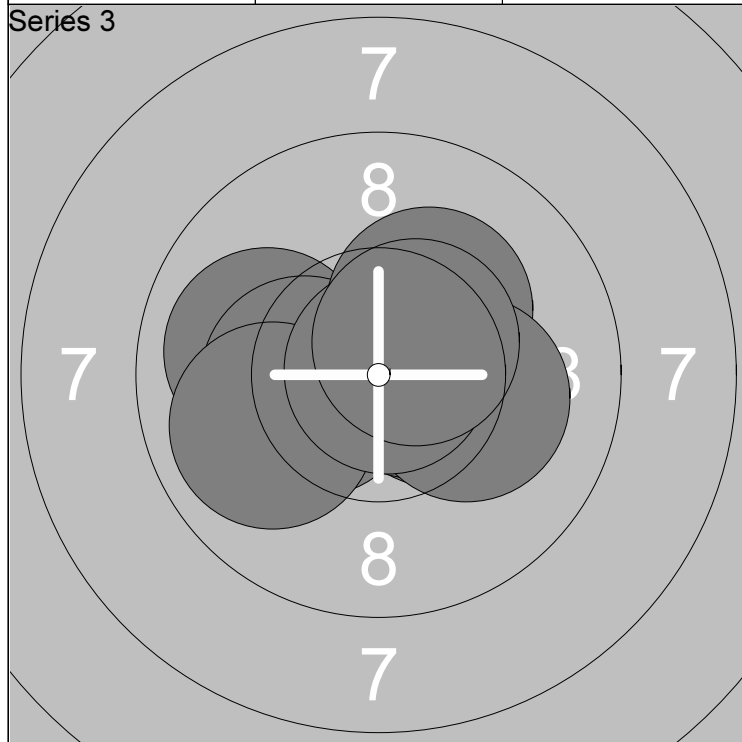

21: *10.4→	26: 9.9 ←	Series	99.0
22: *10.4↙	27: *10.2↗		
23: *10.6→	28: *10.2→	Total	293.0
24: 10.0 ←	29: *10.9↗		
25: *10.3↙	30: *10.5↗		

31: *10.2↙	36: 10.1 ←	Series	98.0
32: *10.4↑	37: *10.4↑		
33: 10.0 ↖	38: *10.5↖	Total	391.0
34: *10.7↓	39: 9.9 →		
35: *10.3↓	40: 9.9 →		

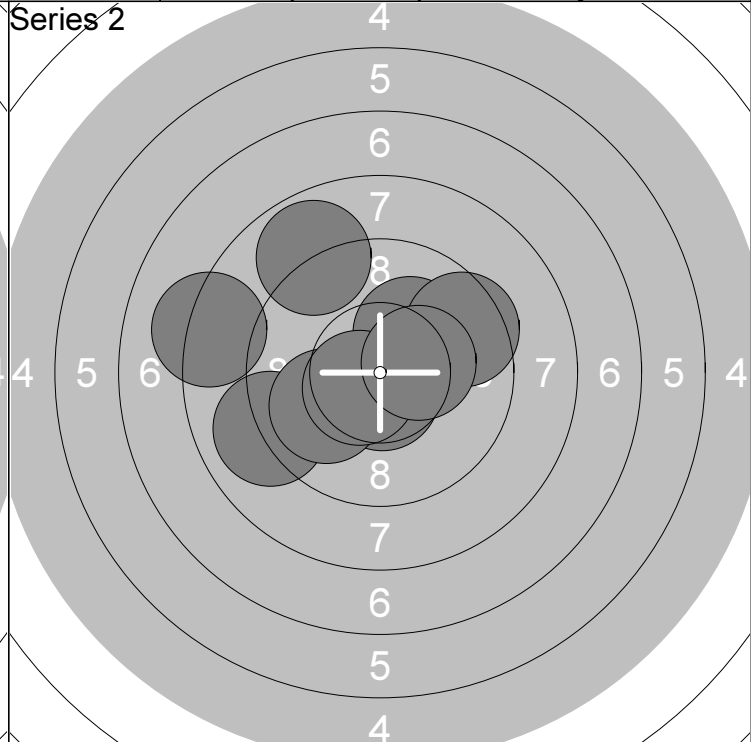
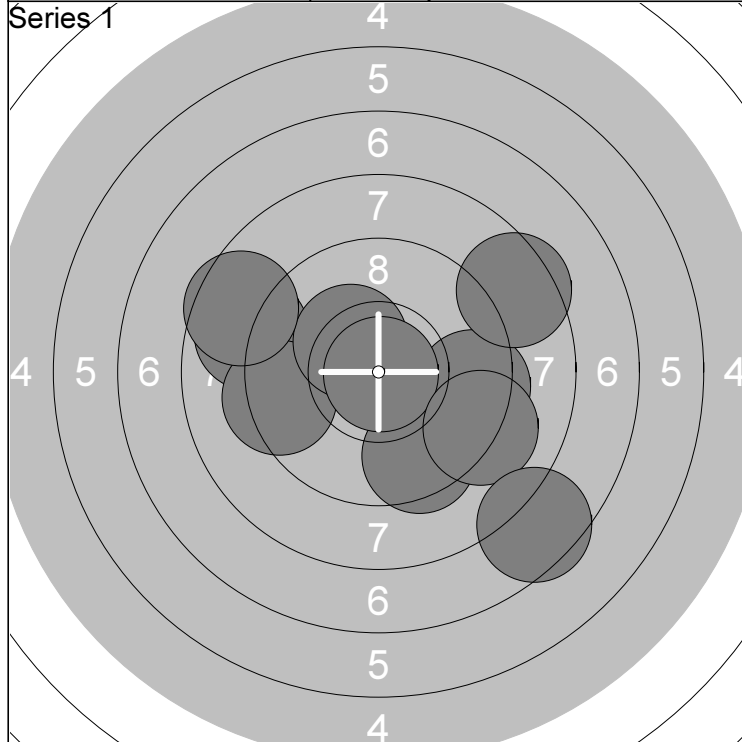

1: 9.4 →	6: *10.3 ↗	Series	87.0	11: *10.5 ↗	16: 8.2 ←	Series	93.0
2: 8.9 ←	7: 8.6 ↙		Total	87.0	12: 9.0 ↙		17: 9.9 ↙
3: 8.5 ↗	8: *10.9 ↘	13: 8.9 ↗		18: *10.6 ↙			
4: 9.5 ↓	9: 9.1 ↘	14: *10.2 ↗	19: 9.5 ↗				
5: 9.3 ←	10: 7.5 ↘	15: *10.6 ↓	20: *10.3 →				

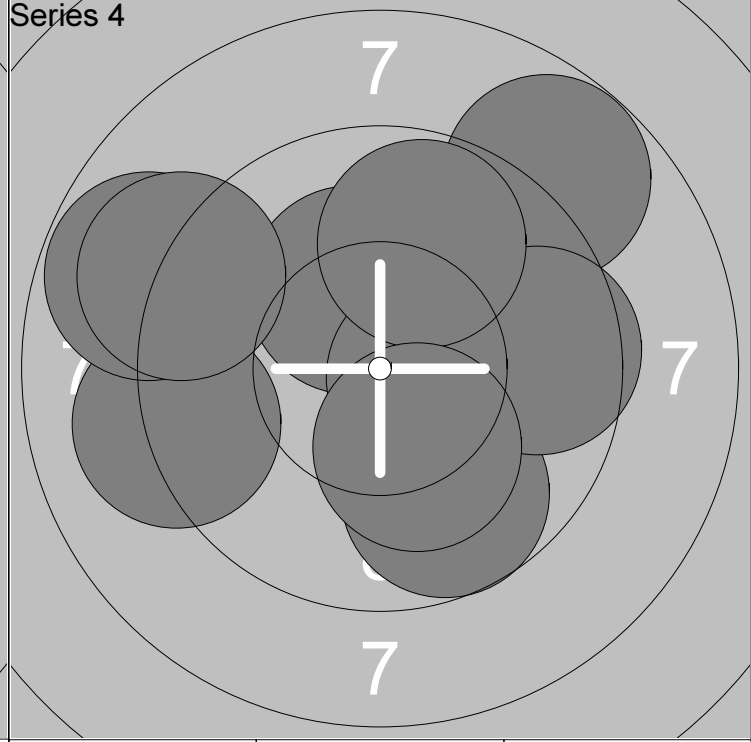
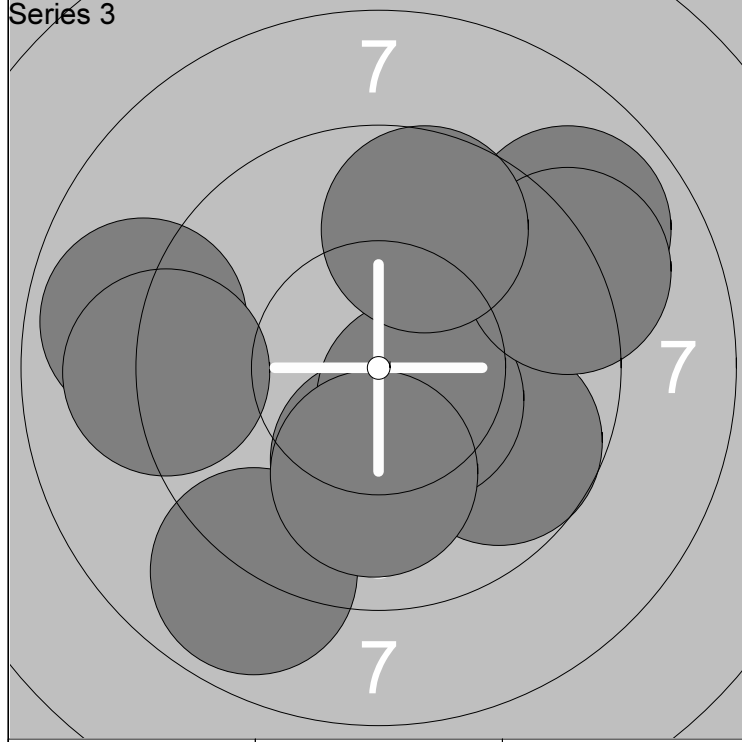

21: 10.1 ↓	26: *10.5 ↘	Series	90.0	31: 9.1 ←	36: 8.8 ↗	Series	91.0
22: 8.9 ←	27: 8.9 ↙		Total	270.0	32: *10.2 ↗		37: 9.6 →
23: 8.9 ↗	28: 9.1 ↗	33: 8.8 ←		38: 9.8 ↗			
24: 9.1 ←	29: 10.0 ↓	34: *10.5 →	39: 9.0 ←				
25: 9.8 ↘	30: 9.7 ↗	35: 9.8 ↓	40: *10.2 ↓				

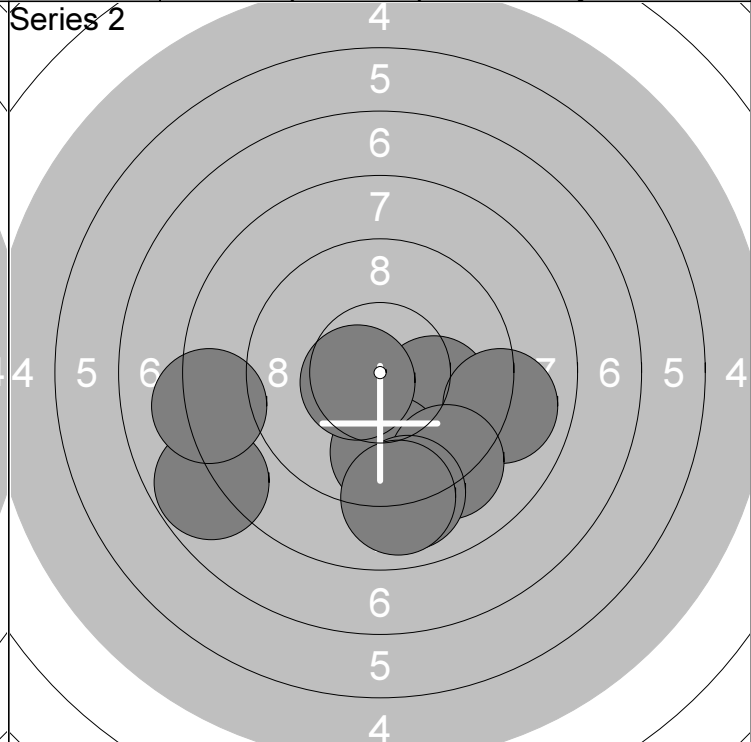
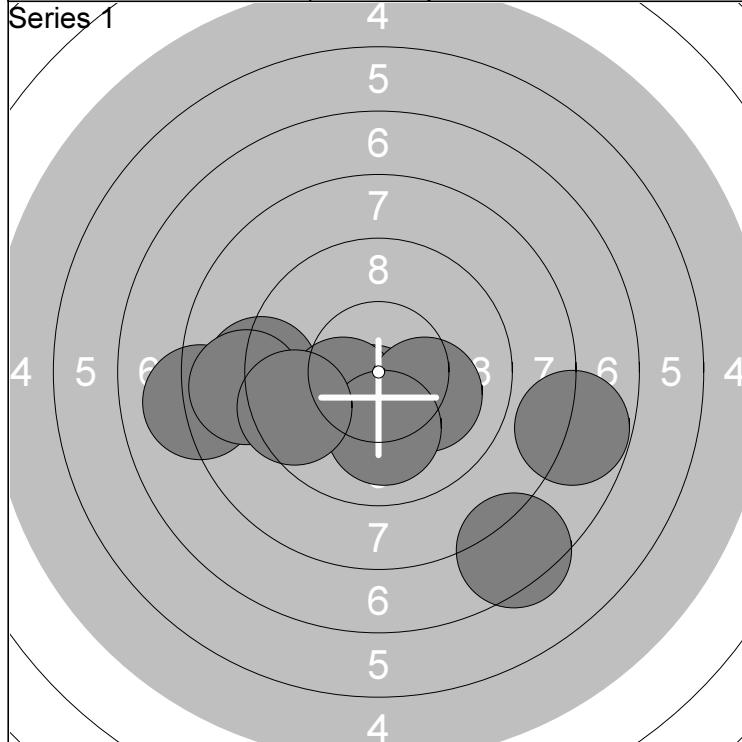

1: 7.4 ↘	6: 10.1 ↗	Series	88.0
2: *10.5 ↓	7: 10.1 ↓		
3: 9.1 ←	8: 8.1 ←	Total	88.0
4: 7.8 →	9: 8.9 ←		
5: *10.3 ↙	10: 9.5 ←		

11: 10.0 ↘	16: 8.2 ←	Series	90.0
12: 7.8 ↙	17: *10.6 ↙		
13: 10.1 ↗	18: 9.2 ↓	Total	178.0
14: 9.7 ↓	19: 9.0 ↓		
15: 9.0 →	20: 9.0 ↓		

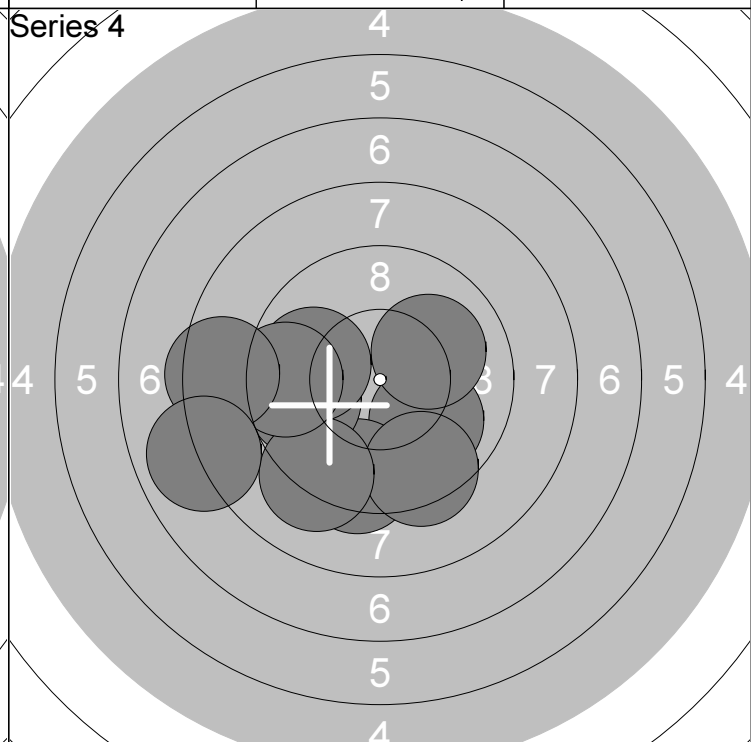
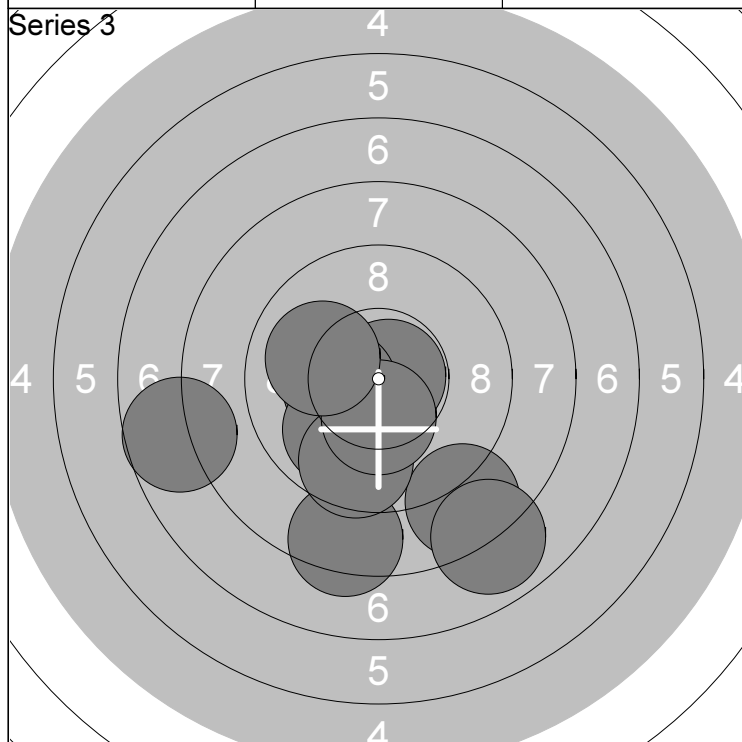

21: *10.8 →	26: 10.0 ↙	Series	89.0
22: 8.6 ↘	27: 9.6 ↓		
23: 8.4 ↓	28: *10.4 ↓	Total	267.0
24: *10.3 ↙	29: 7.7 ←		
25: 7.9 ↘	30: 10.0 ↙		

31: 10.0 ↘	36: 9.2 ↙	Series	90.0
32: 9.4 ↓	37: 9.9 ←		
33: 9.4 ↓	38: 9.5 ←	Total	357.0
34: 9.7 ←	39: 8.5 ←		
35: 10.1 ↗	40: 8.0 ←		

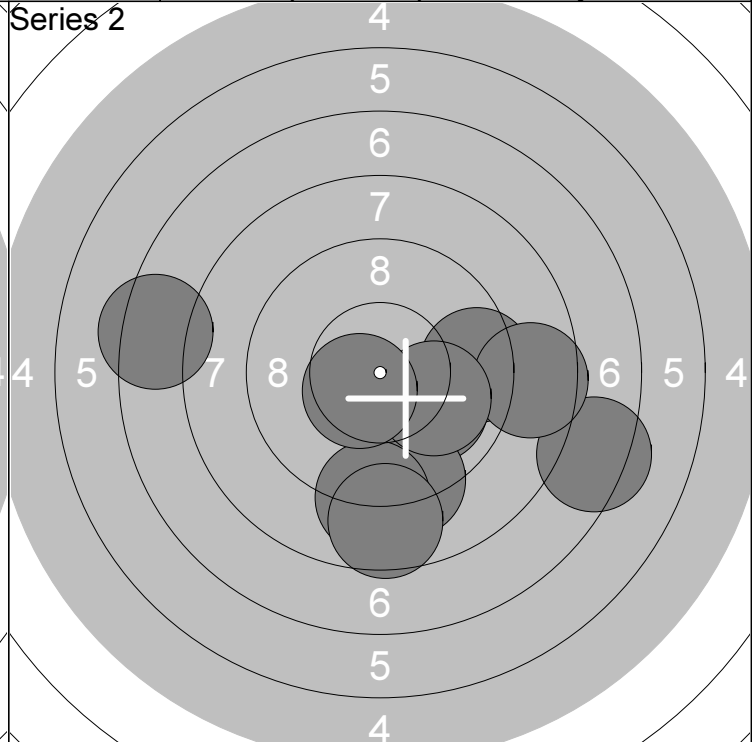
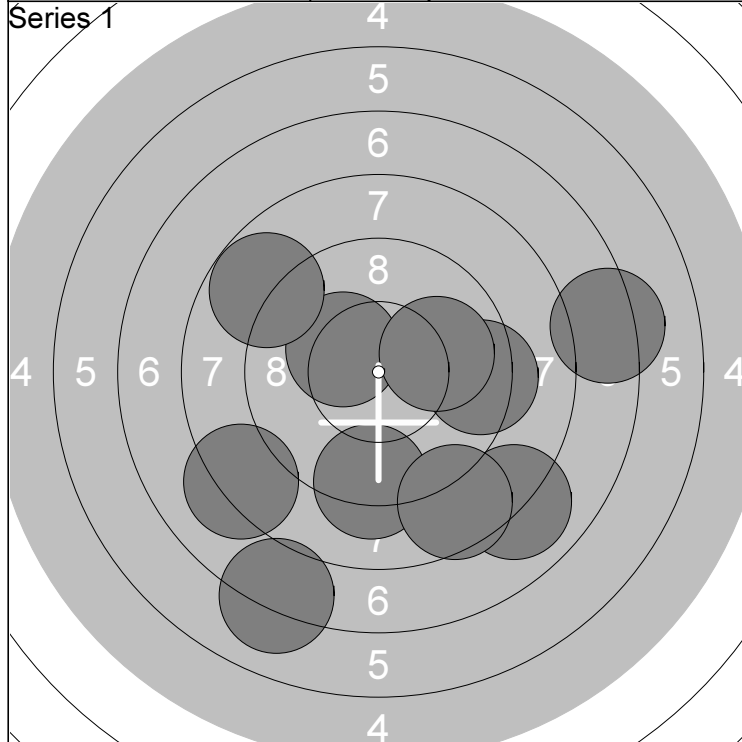

1: 7.3 →	6: 7.1 ↓	<b>Series</b> <b>84.0</b>
2: 8.0 ↓	7: 8.8 ↖	
3: 9.3 →	8: 8.6 ↓	<b>Total</b> <b>84.0</b>
4: *10.3 ↖	9: 10.0 →	
5: 9.2 ↓	10: 8.2 ↖	

11: 10.0 ↘	16: 7.4 ←	<b>Series</b> <b>87.0</b>
12: 9.2 ↓	17: 7.3 →	
13: 9.4 →	18: 8.6 →	<b>Total</b> <b>171.0</b>
14: 9.0 ↓	19: 10.0 ↘	
15: 8.6 ↓	20: *10.5 ↖	

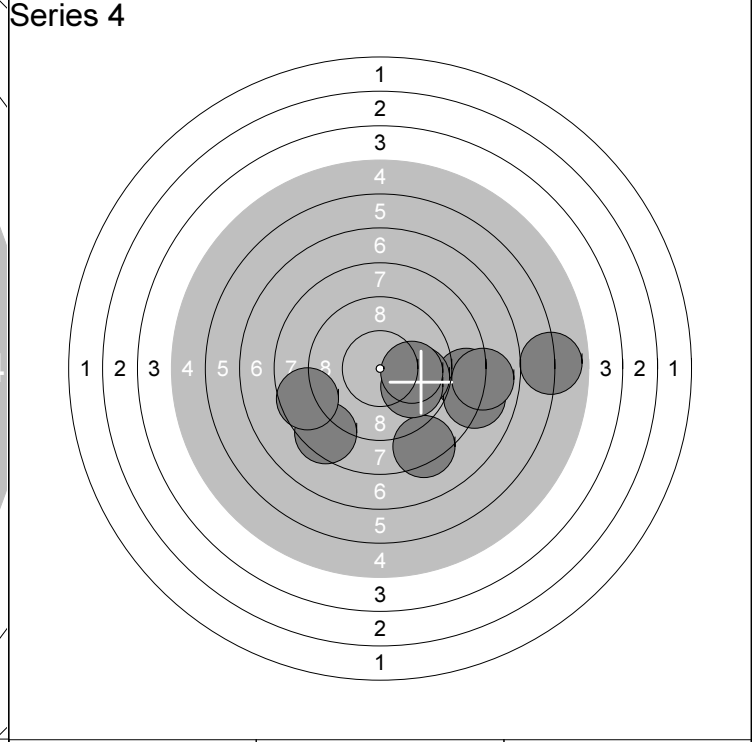
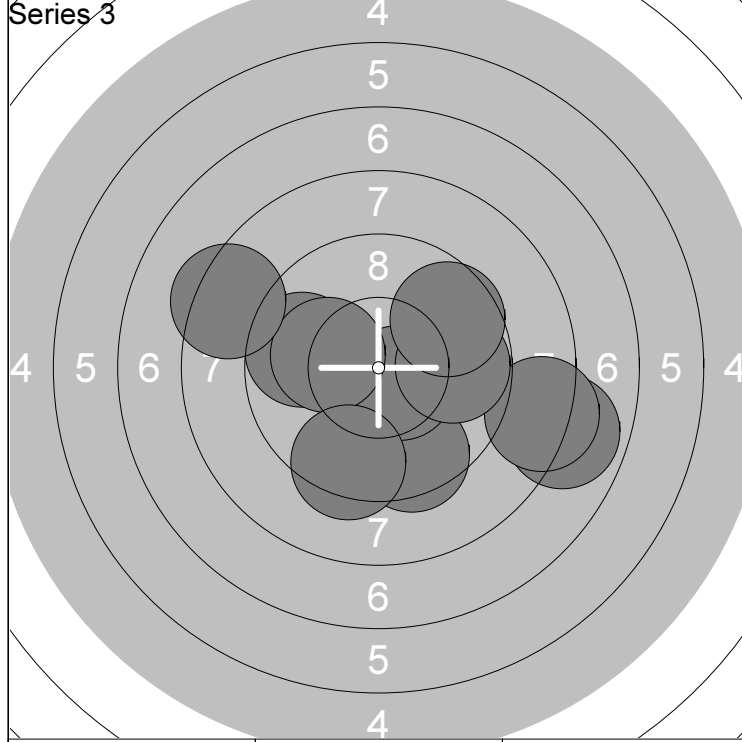

21: 9.7 ←	26: 9.8 →	<b>Series</b> <b>88.0</b>
22: 7.9 →	27: 10.1 ↖	
23: 9.5 ↓	28: 9.4 ↓	<b>Total</b> <b>259.0</b>
24: *10.5 ↘	29: 9.6 ↗	
25: 8.3 →	30: 8.4 ↖	

31: 8.5 ↖	36: 9.8 →	<b>Series</b> <b>81.0</b>
32: 8.4 →	37: 8.3 ↓	
33: 8.1 →	38: 6.0 →	<b>Total</b> <b>340.0</b>
34: 7.9 →	39: 9.9 ↘	
35: 8.6 ←	40: 10.0 →	



Relay <b>2</b>	Lane <b>18</b>	<b>Jere Salo</b>		
-------------------	-------------------	------------------	--	--

Air	NoSA	Y16	R
-----	------	-----	---

09.-10.03.2013	Kevätkilpailu	Kankaanpään Ampumaurheilijat	
----------------	---------------	------------------------------	--

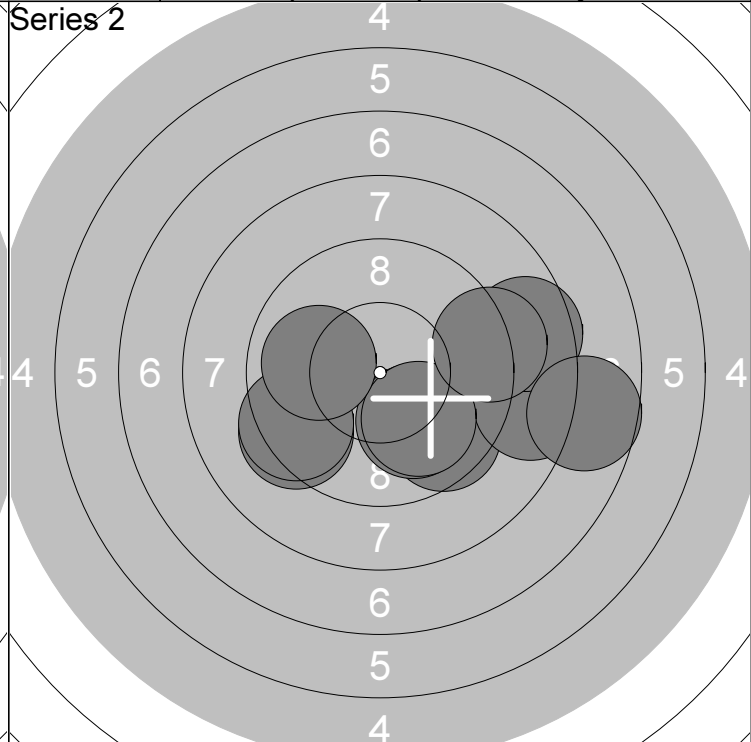
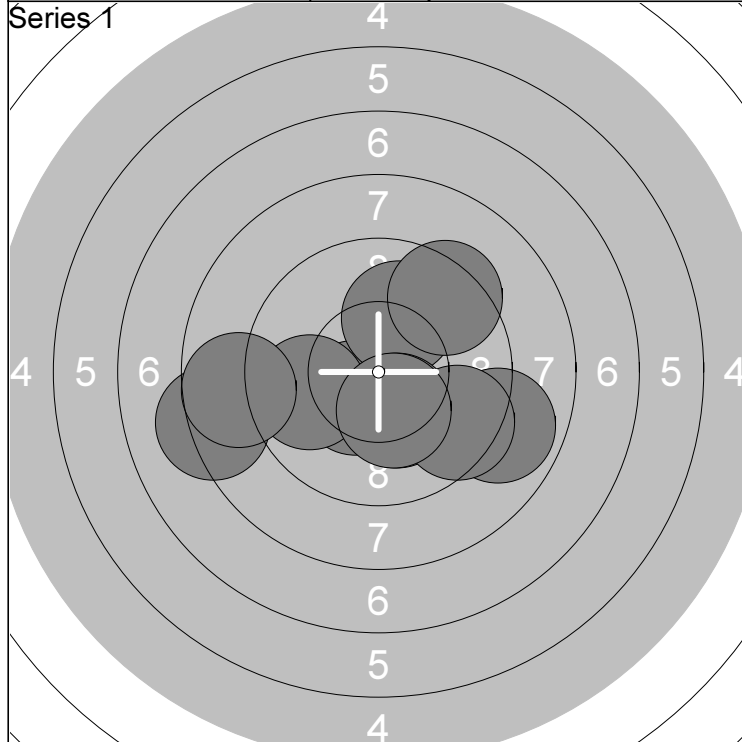

1: *10.4 ↙	6: 9.4 ↗	Series	91.0
2: 8.2 ←	7: *10.3 ↓		
3: 9.8 ←	8: 9.5 ↘	Total	91.0
4: 10.1 ↑	9: *10.3 ↓		
5: 8.9 →	10: 8.7 ←		

11: 9.6 ↘	16: 10.0 ↓	Series	89.0
12: 8.5 →	17: 9.3 ↙		
13: 10.0 ↓	18: 9.4 ↙	Total	180.0
14: 8.6 →	19: 10.0 ←		
15: 7.7 →	20: 9.2 →		

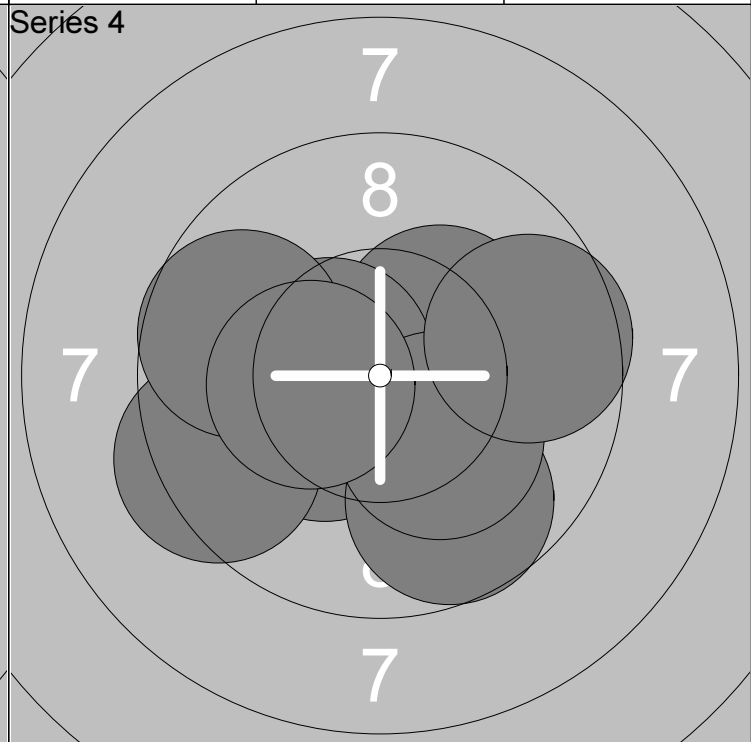
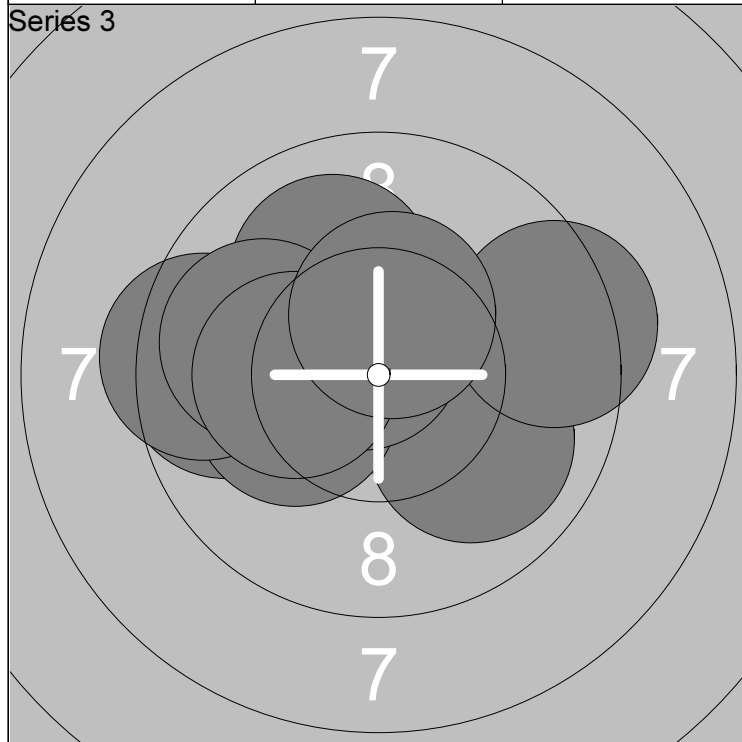

21: 9.6 ←	26: 10.0 ↗	Series	96.0
22: 10.0 ↘	27: 9.4 ←		
23: *10.2 ↙	28: 9.9 ←	Total	276.0
24: 9.4 →	29: *10.2 ↙		
25: *10.7 ↘	30: *10.4 ↑		

31: *10.2 ↓	36: *10.5 ↙	Series	96.0
32: *10.3 ↗	37: *10.2 ↓		
33: *10.3 ↙	38: 9.7 ←	Total	372.0
34: 9.4 ←	39: *10.4 ↙		
35: 9.7 ↘	40: 9.6 →		

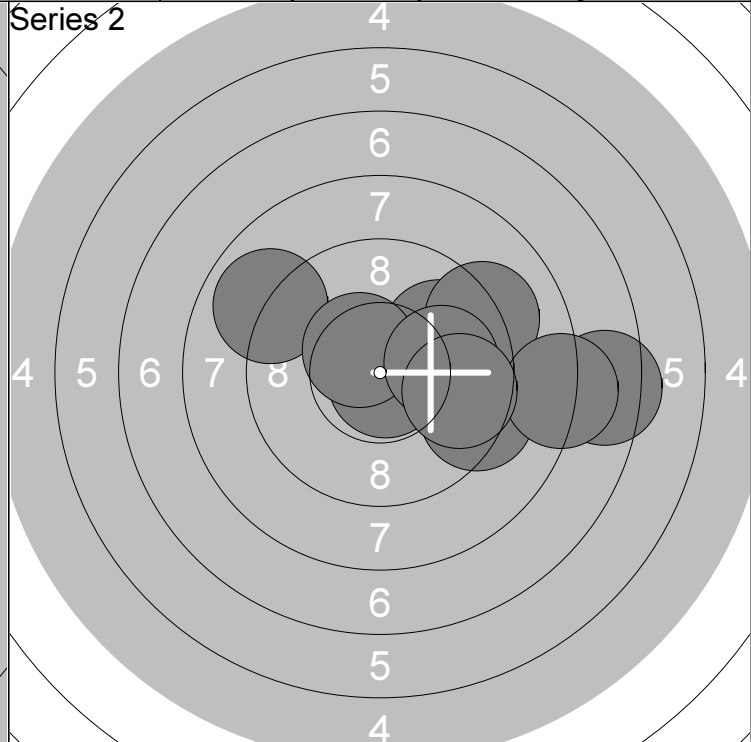
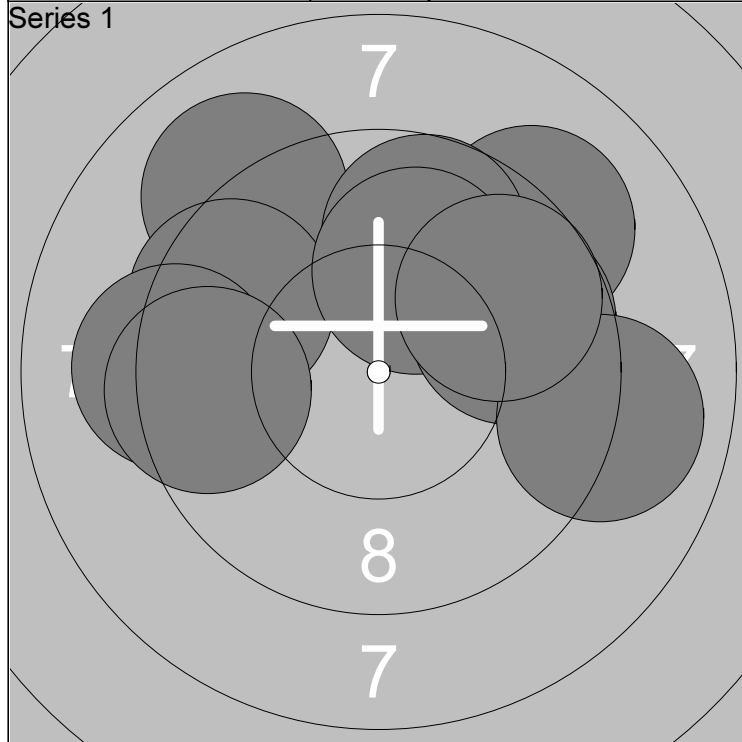

1: 9.1 ↗	6: 9.7 →	Series	91.0
2: 9.1 ↗	7: 9.2 ←		
3: 9.5 ↖	8: 9.5 ←	Total	91.0
4: 9.7 ↑	9: 9.0 →		
5: 10.0 ↑	10: 9.7 →		

11: *10.8 ↘	16: 9.1 →	Series	89.0
12: 8.9 ↖	17: 10.0 →		
13: 9.8 ↗	18: 7.4 →	Total	180.0
14: *10.5 ↖	19: 8.1 →		
15: 9.3 →	20: 9.7 →		

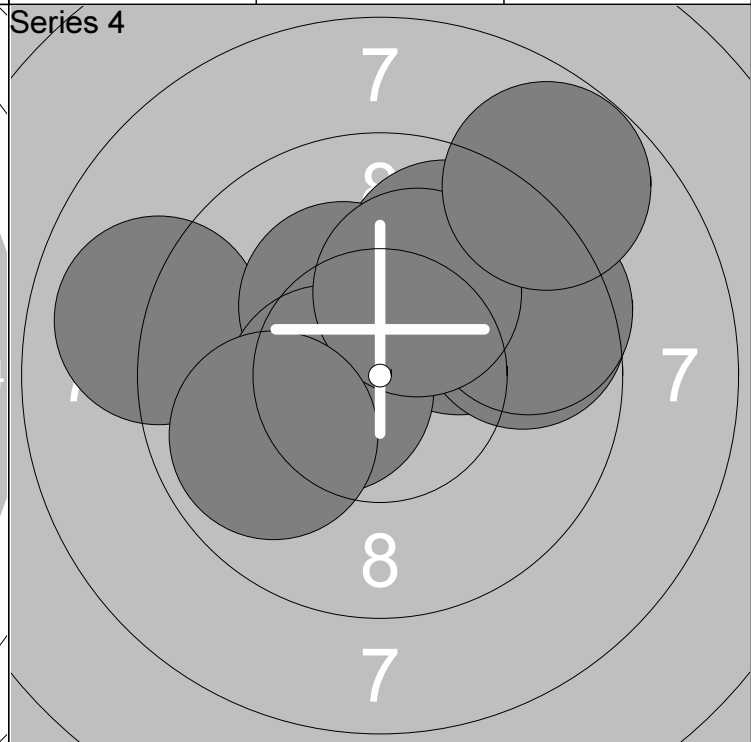
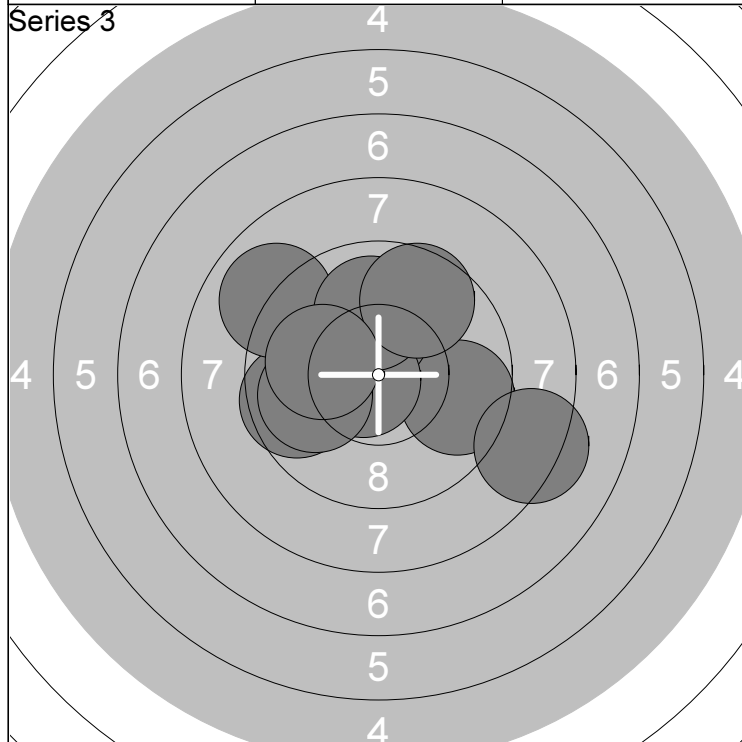

21: 9.6 →	26: 8.3 →	Series	93.0
22: 9.6 ←	27: 9.9 ←		
23: *10.2 ↑	28: 10.0 ↑	Total	273.0
24: 9.0 ↖	29: 9.6 ↑		
25: *10.7 ↖	30: 10.1 ←		

31: 9.8 ↑	36: 9.6 →	Series	93.0
32: 9.0 ←	37: *10.5 ↖		
33: 10.1 ↗	38: *10.2 ↑	Total	366.0
34: *10.3 ↖	39: 9.9 ←		
35: 9.6 →	40: 8.8 ↑		

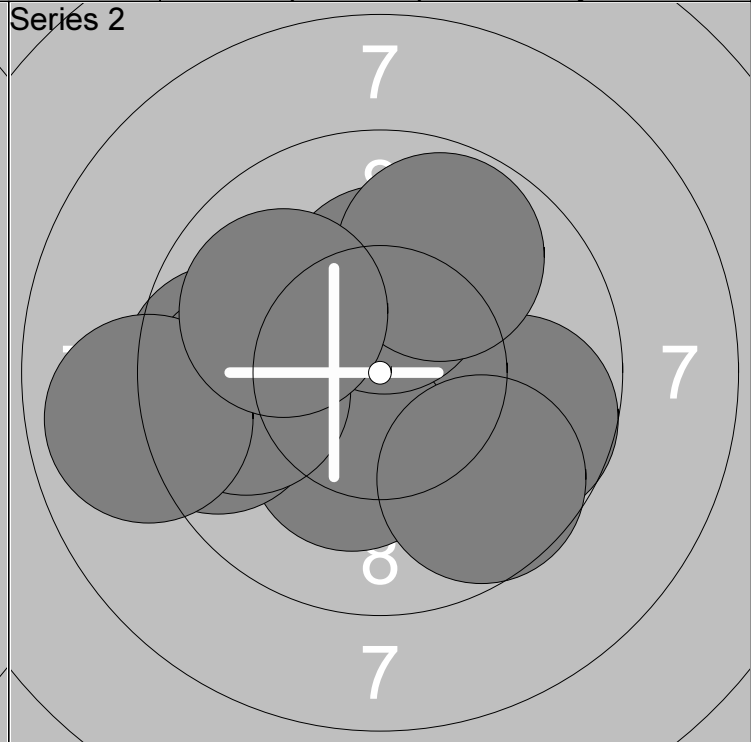
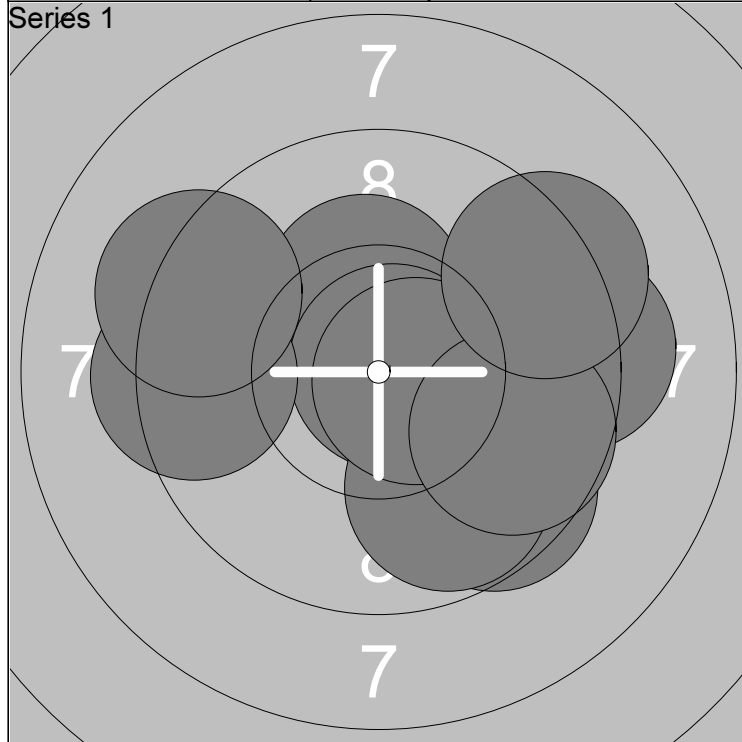

1: 9.2 →	6: *10.6 →	Series	93.0
2: *10.3 ↑	7: 9.7 →		
3: 9.5 ↓	8: 9.3 ←	Total	93.0
4: *10.8 →	9: 9.2 ←		
5: 9.8 ↓	10: 9.3 ↗		

11: 9.7 →	16: 9.6 ←	Series	92.0
12: *10.3 ↓	17: 9.8 ←		
13: 9.7 ↓	18: 8.9 ←	Total	185.0
14: 9.5 ←	19: 9.8 ↑		
15: *10.2 ↑	20: 10.0 ↙		

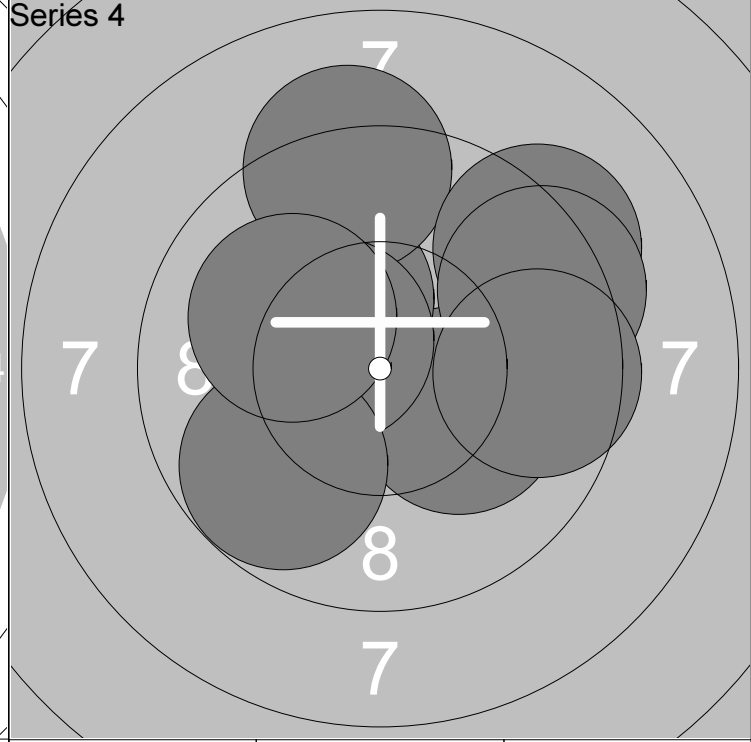
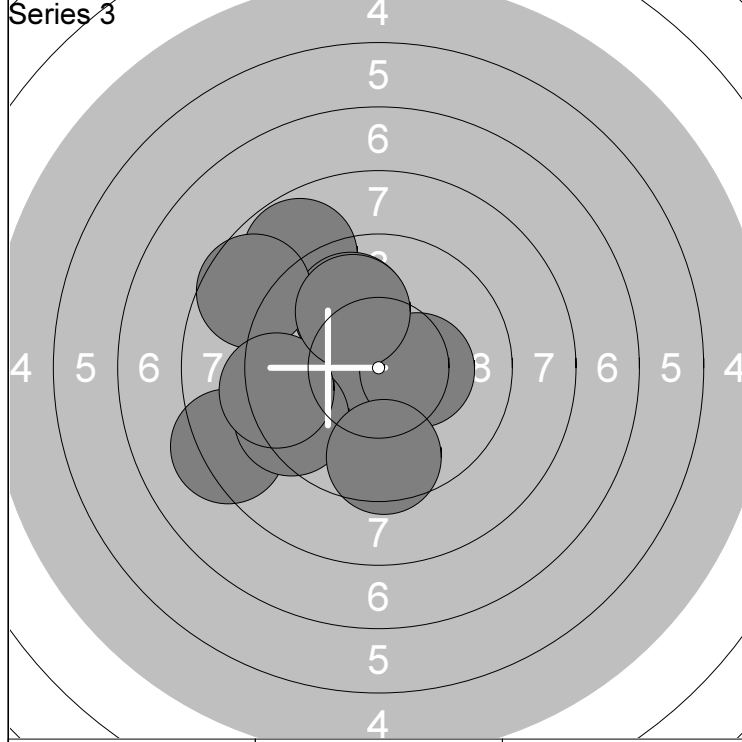

21: *10.6 ↙	26: 8.3 ←	Series	90.0
22: 8.8 ↗	27: 9.4 ↙		
23: 9.9 ↗	28: 9.3 ←	Total	275.0
24: 8.6 ↗	29: 9.6 ↓		
25: *10.4 →	30: 10.0 ↗		

31: *10.2 ↖	36: 9.2 ↗	Series	95.0
32: *10.2 →	37: 9.4 ↗		
33: *10.2 ↖	38: 9.8 ↙	Total	370.0
34: 9.2 ↑	39: 10.1 ↙		
35: *10.5 ↖	40: 9.6 →		